

TAPERED ROLLER BEARINGS





Contents

Engineering	4
Basic Features	4
Common Bearing Styles	5
Internal Designs	6
Bearing Arrangement	6
Basic Dynamic Radial Load Rating (Cr)	6
Basic Static Radial Load Rating (Cor)	6
Determining Radial and Axial Forces Acting on the Bearing	7
Dynamic Equivalent Radial Load	8
Radial and Thrust Load Factors X and Y for Determining the Dynamic Equivalent Radial Load	8
Determining Dynamic Equivalent Radial Load Based on Load Conditions	8
Basic Rating Life (L10)	8
The Life Calculation under Equivalent Radial Load	8
Reference Speed	9
Setting	9
Part Numbering (Inch & J Prefix Metric)	10
Part Numbering (ISO Metric)	11
Custom Bearings	12
Inch Tolerances	13
J Prefix Metric Tolerances	14
ISO Metric Tolerances	15
Inch Fitting Practices	16
ISO And J Prefix Metric Fitting Practices	17
Inch Series	18
ISO Metric Series	86
Inch and ISO Metric Series By Cone Bore	96



About PEER

Since 1941, PEER Bearing has grown into an industry leader offering a wide range of highly engineered, precision bearing products. PEER manufactures, develops, and engineers bearing solutions to global market leaders. PEER provides a wide range of agricultural, radial, mounted unit ball bearings and tapered roller bearings to many major market segments including agricultural, industrial transmission, electrical, fluid, material handling, and off-highway.

Supplying award winning, precision tailored solutions starts with an in-depth knowledge and evaluation by industry-specific application engineers. Bearing requirements are translated into engineered solutions, manufactured at our ISO/TS 16949 certified facilities and validated through lab and field testing. With facilities in North America, Europe, Latin America and Asia, we provide solutions that you can rely on at every turn.

Our Commitment

Our commitment to the future of PEER is built on fulfilling your needs. Your satisfaction as a customer is the foundation of PEER and is supported by...

- First class customer service
- On-time scheduled delivery
- Continuous product innovation
- Customized product design based on customer requirements
- In-depth inventory
- Technical and engineering support
- In-house and independent test facilities
- TS 16949 certified manufacturing facilities and ISO 9001 distribution facilities
- Superior quality in features and appearance

Basic Features

A tapered roller bearing (TRB) consists of a cone assembly (with rollers and cage) and cup that are separable. Shown in Figure 1 are the components that make up a tapered roller bearing set. The rings and rollers are designed to carry load, while the cage is only intended to retain and space the rollers. Because the cone and cup are separable, they can be installed individually and set with preload or clearance to achieve optimum bearing performance in the application. The basic design of a TRB allows it to carry both axial and radial load. Typically the greater the contact angle of a TRB, the greater thrust load it has the potential to carry. The internal features of TRB's require a deep understanding to ensure the product is properly designed and accurately manufactured. PEER products contain features like optimized rollers, raceway surface finishes, controlled roller to rib contact, and undercut designs that significantly improve bearing performance and machine service life.

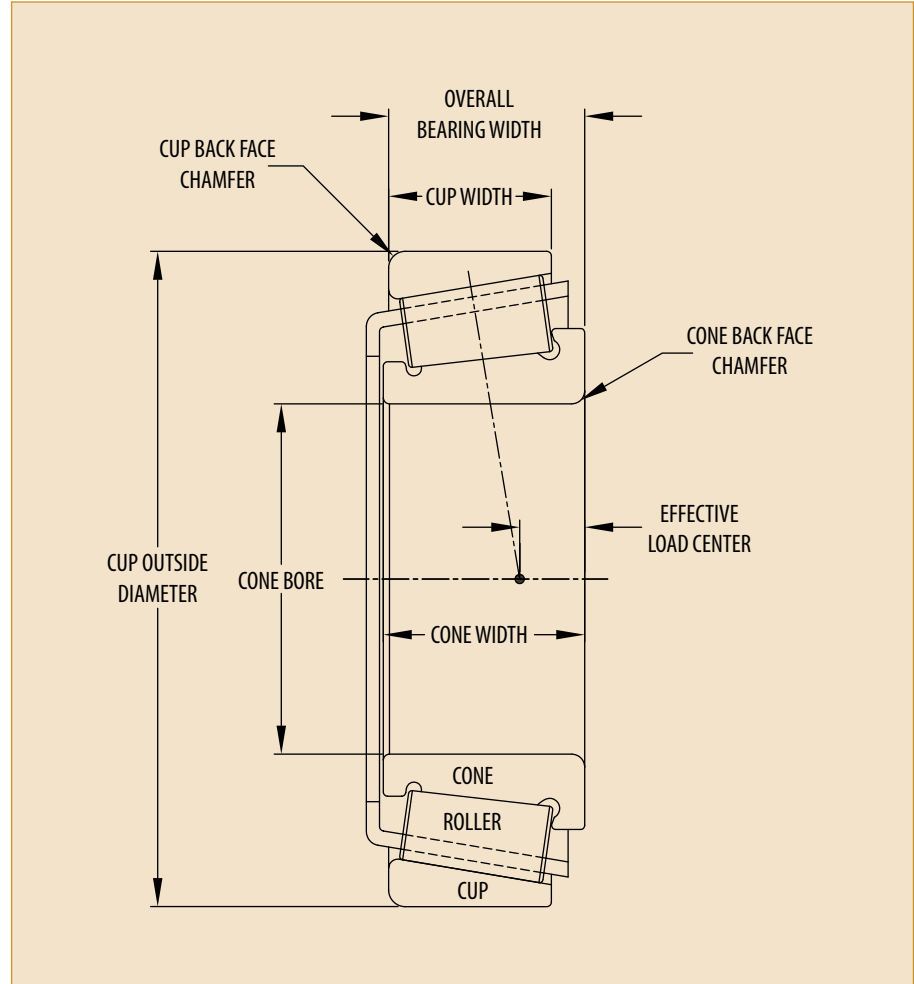
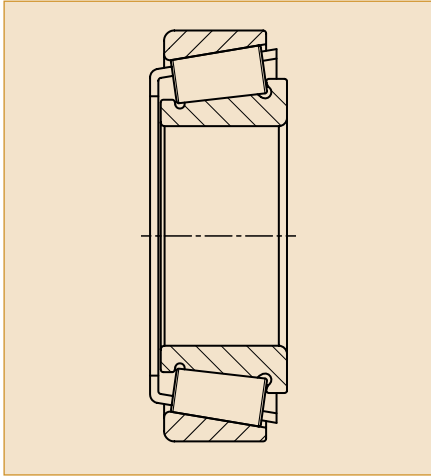

Figure 1. Tapered Roller Bearing Assembly

Common Bearing Styles



Single Row TRB

Single-row tapered roller bearings (TRB) are intended for use in applications where loads are applied in axial & radial directions. Due to the large amount of contact between the rollers and raceways, they can be used in particularly heavy load conditions. PEER TRB's are available in Inch, J Prefix Metric, and ISO Metric Series sizes and are globally interchangeable for use in existing or new applications. PEER manufactures TRB's using high quality, through hardened, 1% carbon bearing steel.

Value in using a single row TRB

- Can be deployed in relatively compact areas compared to other bearing types
- Internal geometries can be modified to meet load requirements & extend life
- During installation, clearance can be adjusted to maximize performance

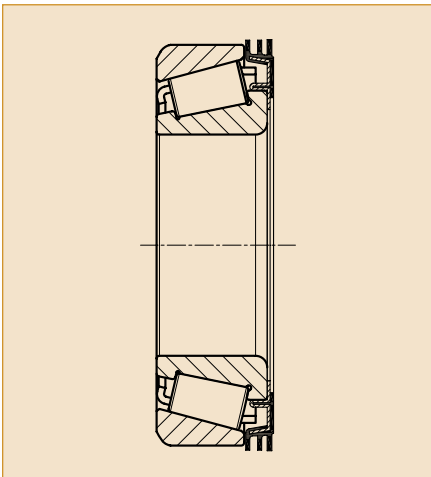

Sealed TRB

Single-row TRB's are typically open and do not have protection from environmental contaminants. They are mounted adjacent to an external shaft seal that prevents contaminants from damaging the bearing. One alternative to an external shaft seal is to integrate the seal directly onto the TRB. PEER sealed TRB's are available in Inch, J Prefix Metric, and ISO Metric Series sizes. They are globally interchangeable and can be dropped into existing applications.

Value in using a Sealed TRB

- Retains grease in the bearing cavity to extend service life
- Prevents contaminant ingress to extend service life
- Reduces cost by eliminating external shaft seal and the assembly operation

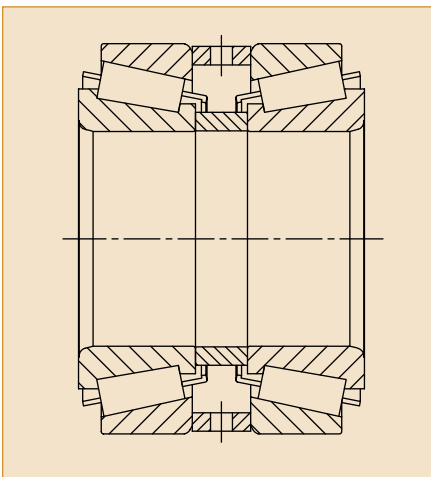

Double Row TRB Assembly

Any two single-row TRB's of the same size/series can be supplied as a double-row, pre-set, ready-to-mount assembly with the addition of spacers. The spacers are machined to width dimensions that provide proper bearing setting after installation. The two options for bearing setting are end play or preload. The application dictates which setting is appropriate to maximize bearing life & this is determined by a PEER Application Engineer (AE). It's also possible to modify assembly widths for an application, by varying the spacer widths.

Value in using a Double Row TRB Assembly

- Prepackaged (by PEER) as a set to significantly reduce assembly time and cost
- Predetermined end play or preload eliminates risk of improper bearing setting during mounting and the costs associated with premature bearing failure
- Eliminates costs associated with planning for multiple assembly components

Internal Designs

Not all TRB applications are equal. The load conditions can vary significantly and can consist of radial load, axial load, combined load or misalignment at the bearing positions. Under these conditions, the bearing can be susceptible to increased internal contact stress and must be designed to reduce this whenever possible. PEER has developed technology that allows the bearing to accept significant misalignment without a reduction in life. In doing so, the contact stress within the bearing is reduced and bearing service life is maximized. For a general explanation of bearing selection depending on applied load conditions, refer to Figure 2. For applications where loads impart a misaligned condition at the bearings, consult with a PEER AE to ensure proper bearing selection.

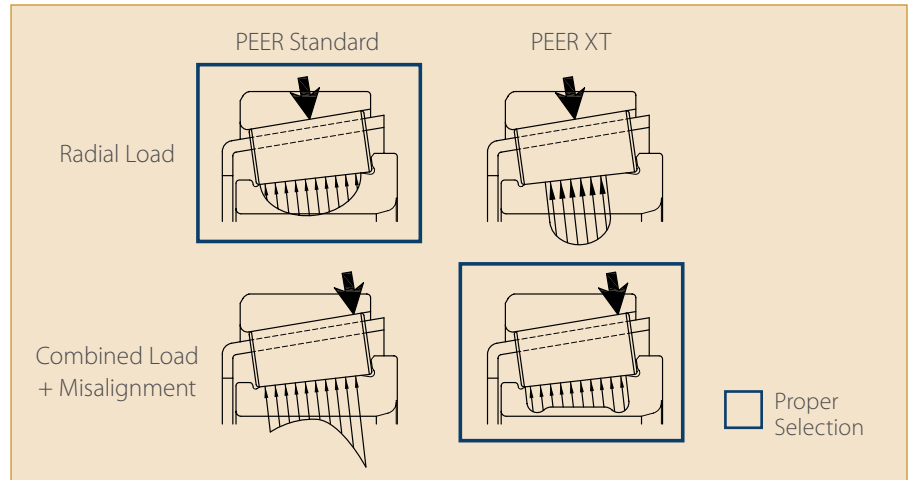
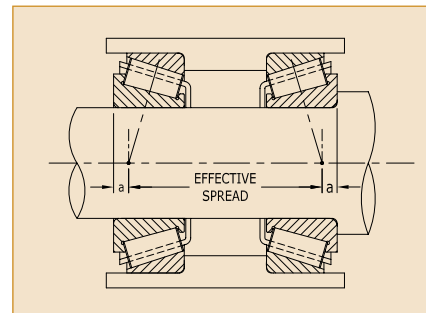

Figure 2. Stress distribution of available PEER designs.

Bearing Arrangement

Single-row Tapered roller bearings can accept axial load from one direction only so they are usually mounted in pairs in either a direct or indirect arrangement. The arrangement type and spacing distance must be considered to accurately resolve the forces applied to each pair of bearing sets. The effective spread between the same set of bearings is smaller with direct mounting than with indirect mounting. An indirect mounting arrangement (also referred to as an O arrangement), is relatively stiff and can accommodate tilting moments better than a direct mounting arrangement (also referred to as an X arrangement).



Indirect Mounting (O arrangement)

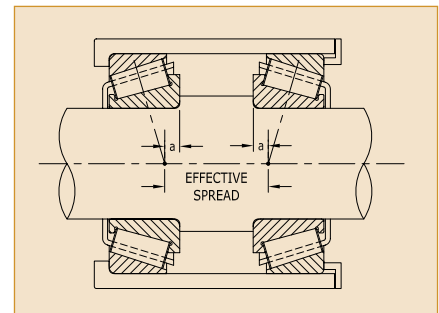

Direct Mounting (X arrangement)

Basic Dynamic Radial Load Rating (Cr)

Rating used for calculations involving dynamically stressed bearings, when selecting a bearing which is to rotate under load. It expresses the bearing radial load which will give a basic rating life of one million revolutions. Dynamic load ratings provided in the product tables are calculated in accordance with ISO 281.

Basic Static Radial Load Rating (Cor)

The Basic Static Radial Load Rating is the static radial load which results in a calculated contact stress of 4000 MPa at the center of the most heavily loaded rolling element/raceway contact. It is used in calculations involving relatively slow rotational speeds, slow oscillating movements or no movement under load. This load would theoretically produce a total permanent deformation of approximately one ten-thousandth of the rolling element diameter. Static load ratings provided in the product tables are calculated in accordance with ISO 76.

Determining Radial and Axial Forces Acting on the Bearing

Before the dynamic equivalent radial load (P) can be calculated, the resultant radial and axial loads acting on the bearing need to be calculated. The table below shows the formulas to calculate the resultant bearing loads.

F_{ea} = The external axial force acting on the bearing arrangement.

F_{rA}, F_{rB} = The resultant radial forces acting on bearings A and B.

F_{aA}, F_{aB} = The resultant axial forces on bearings A and B.

e_A, e_B = Limiting values of F_a/F_r for bearings A and B.

Y_A, Y_B = Dynamic axial load factors for bearings A and B.

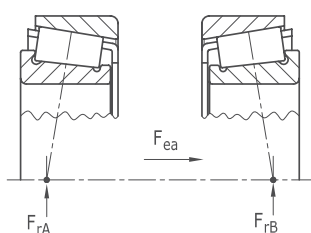
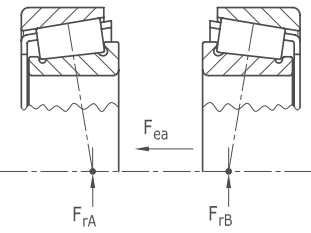
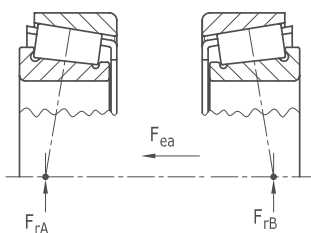
Bearing Arrangement	Load Condition	Axial Load	Equivalent Load
	$\frac{F_{rA}}{Y_A} \leq \frac{F_{rB}}{Y_B}$ $F_{ea} \geq 0$	$F_{aA} = \frac{0.5 \cdot F_{rB}}{Y_B} + F_{ea}$	$\frac{F_{aA}}{F_{rA}} \leq e_A \Rightarrow P_A = F_{rA}$ $\frac{F_{aA}}{F_{rA}} > e_A \Rightarrow P_A = 0.4F_{rA} + Y_A \cdot \left(\frac{0.5 \cdot F_{rB}}{Y_B} + F_{ea} \right)$
	$\frac{F_{rA}}{Y_A} > \frac{F_{rB}}{Y_B}$ $F_{ea} \geq 0.5 \cdot \left(\frac{F_{rA}}{Y_A} - \frac{F_{rB}}{Y_B} \right)$	$F_{aB} = \frac{0.5 \cdot F_{rB}}{Y_B}$	$\frac{F_{aB}}{F_{rB}} \leq e_B \Rightarrow P_B = F_{rB}$ $\frac{F_{aB}}{F_{rB}} > e_B \Rightarrow P_B = 0.9F_{rB}$
	$\frac{F_{rA}}{Y_A} > \frac{F_{rB}}{Y_B}$ $F_{ea} < 0.5 \cdot \left(\frac{F_{rA}}{Y_A} - \frac{F_{rB}}{Y_B} \right)$	$F_{aA} = \frac{0.5 \cdot F_{rA}}{Y_A}$ $F_{aB} = \frac{0.5 \cdot F_{rA}}{Y_A} - F_{ea}$	$\frac{F_{aA}}{F_{rA}} \leq e_A \Rightarrow P_A = F_{rA}$ $\frac{F_{aA}}{F_{rA}} > e_A \Rightarrow P_A = 0.9F_{rA}$ $\frac{F_{aB}}{F_{rB}} \leq e_B \Rightarrow P_B = F_{rB}$ $\frac{F_{aB}}{F_{rB}} > e_B \Rightarrow P_B = 0.4F_{rB} + Y_B \cdot \left(\frac{0.5 \cdot F_{rA}}{Y_A} - F_{ea} \right)$
	$\frac{F_{rA}}{Y_A} \geq \frac{F_{rB}}{Y_B}$ $F_{ea} \geq 0$	$F_{aA} = \frac{0.5 \cdot F_{rA}}{Y_A}$	$\frac{F_{aA}}{F_{rA}} \leq e_A \Rightarrow P_A = F_{rA}$ $\frac{F_{aA}}{F_{rA}} > e_A \Rightarrow P_A = 0.9F_{rA}$
	$\frac{F_{rA}}{Y_A} < \frac{F_{rB}}{Y_B}$ $F_{ea} \geq 0.5 \cdot \left(\frac{F_{rB}}{Y_B} - \frac{F_{rA}}{Y_A} \right)$	$F_{aB} = \frac{0.5 \cdot F_{rA}}{Y_A} + F_{ea}$	$\frac{F_{aB}}{F_{rB}} \leq e_B \Rightarrow P_B = F_{rB}$ $\frac{F_{aB}}{F_{rB}} > e_B \Rightarrow P_B = 0.4F_{rB} + Y_B \cdot \left(\frac{0.5 \cdot F_{rA}}{Y_A} + F_{ea} \right)$
	$\frac{F_{rA}}{Y_A} < \frac{F_{rB}}{Y_B}$ $F_{ea} < 0.5 \cdot \left(\frac{F_{rB}}{Y_B} - \frac{F_{rA}}{Y_A} \right)$	$F_{aA} = \frac{0.5 \cdot F_{rB}}{Y_B} - F_{ea}$ $F_{aB} = \frac{0.5 \cdot F_{rB}}{Y_B}$	$\frac{F_{aA}}{F_{rA}} \leq e_A \Rightarrow P_A = F_{rA}$ $\frac{F_{aA}}{F_{rA}} > e_A \Rightarrow P_A = 0.4F_{rA} + Y_A \cdot \left(\frac{0.5 \cdot F_{rB}}{Y_B} - F_{ea} \right)$ $\frac{F_{aB}}{F_{rB}} \leq e_B \Rightarrow P_B = F_{rB}$ $\frac{F_{aB}}{F_{rB}} > e_B \Rightarrow P_B = 0.9F_{rB}$

Dynamic Equivalent Radial Load (P)

The dynamic equivalent radial load represents a radial load that, if applied to the bearing, will produce the same affect on the life of the bearing equal to that which would occur under combined axial and radial loading. This value is required for calculating bearing life. Radial loads induce axial reaction forces in tapered roller bearings that must be taken into account.

For constant loads the dynamic equivalent radial load can be calculated using the following equation: $P = X \cdot F_r + Y \cdot F_a$

Where:

P = Dynamic equivalent radial bearing load (lbf, kN)

F_r = Radial bearing load (lbf, kN)

F_a = Axial bearing load (lbf, kN)

X = Dynamic radial load factor

Y = Dynamic axial load factor

Radial and Thrust Load Factors X and Y for Determining the Dynamic Equivalent Radial Load for Radial Roller Bearings

Bearing Type	$\frac{F_a}{F_r} \leq e$		$\frac{F_a}{F_r} > e$		e
	X	Y	X	Y	
Single row, $\alpha \neq 0^\circ$	1	0	0.40	Refer to Y in product tables	Refer to e in product tables

Determining Dynamic Equivalent Radial Load Based on Load Conditions

In applications with a constant speed, where the load grows linearly from a minimum value (P_{min}) to a maximum (P_{max}), then drops back to the minimum value, the average load can be approximated by:

$$P = \frac{(P_{min} + 2P_{max})}{3}$$

Where P = Constant dynamic equivalent radial bearing load

When a roller bearing is subjected to variable load and speed conditions, the constant dynamic equivalent radial load P can be calculated by:

$$P = \sqrt[10/3]{\frac{(P_1^{10/3} \cdot n_1 \cdot t_1) + (P_2^{10/3} \cdot n_2 \cdot t_2) + \dots + (P_n^{10/3} \cdot n_n \cdot t_n)}{(n_1 \cdot t_1) + (n_2 \cdot t_2) + \dots + (n_n \cdot t_n)}}$$

Where

P_1 = Constant dynamic equivalent load at n_1 RPM for t_1 minutes

P_2 = Constant dynamic equivalent load at n_2 RPM for t_2 minutes

P_n = Constant dynamic equivalent load at n_n RPM for t_n minutes

When a roller bearing is subjected to variable load but constant speed, the constant dynamic equivalent load P can be calculated by:

$$P = \sqrt[10/3]{\frac{(P_1^{10/3} \cdot t_1) + (P_2^{10/3} \cdot t_2) + \dots + (P_n^{10/3} \cdot t_n)}{t_1 + t_2 + \dots + t_n}}$$

Where

P_1 = Constant dynamic equivalent load for t_1 minutes

P_2 = Constant dynamic equivalent load for t_2 minutes

P_n = Constant dynamic equivalent load for t_n minutes

Basic Rating Life (L10)

The life of an individual bearing is defined as the number of revolutions which the bearing is capable of enduring before fatigue occurs on one of its raceways or rolling elements. The basic rating life is based on the life that 90% of a group of identical bearings can be expected to reach or exceed. Basic rating life assumes adequate lubrication throughout the life of the bearing, the bearing is made of good quality bearing steel, and that the bearing is properly supported and aligned.

The Life Calculation Under Equivalent Radial Load

The relationship between the basic rating life, the basic dynamic radial load rating and the bearing load for roller bearings (per ISO 281) is expressed by the equation:

$$L_{10} = \left(\frac{C_r}{P}\right)^{10/3}$$

Where:

L_{10} = Basic rating life in millions of revolutions

C_r = Basic dynamic radial load rating (lbf, N)

P = Dynamic equivalent radial bearing load (lbf, N)

For cases where $P > 0.5C_r$, PEER Engineering should be consulted.

For roller bearings operating at constant speed a basic catalog life expressed in operating hours uses the equation:

$$L_{10h} = \left(\frac{C_r}{P}\right)^{10/3} \cdot \frac{16,667}{n}$$

Where:

L_{10h} = basic life in operating hours

n = rotational speed in revolutions per minute

Reference Speed

The speeds listed in the product tables are thermal reference speeds for oil lubricated bearings calculated based on ISO 15312. The reference speed is calculated for a given bearing operating under specific loads and certain lubricant viscosity. These reference conditions are defined in the ISO standards based on operating conditions that most bearing sizes and types will observe. Speed under these conditions is based on the equilibrium maintained between the heat that is generated by the bearing and the heat dissipated from the bearing to mating components and lubricant. Reference speeds can be exceeded under some conditions.

Setting

One feature of tapered roller bearings is that the cup and cone are separable, allowing for both components to be mounted individually rather than as a unit. This allows the user to adjust the bearing setting to have either end play or preload.

End play: The amount of axial movement of the shaft, relative to the bearings, from one extreme to the other (reference Figure C).

Preload: Negative clearance/end play between the rollers and raceways (reference Figure A)

Line to line: The condition where end play and preload are both zero (reference Figure B).

Mounted Setting: The amount of preload or end play within the bearing after mounting.

Operating Setting: The amount of preload or end play within the bearing under operating conditions.

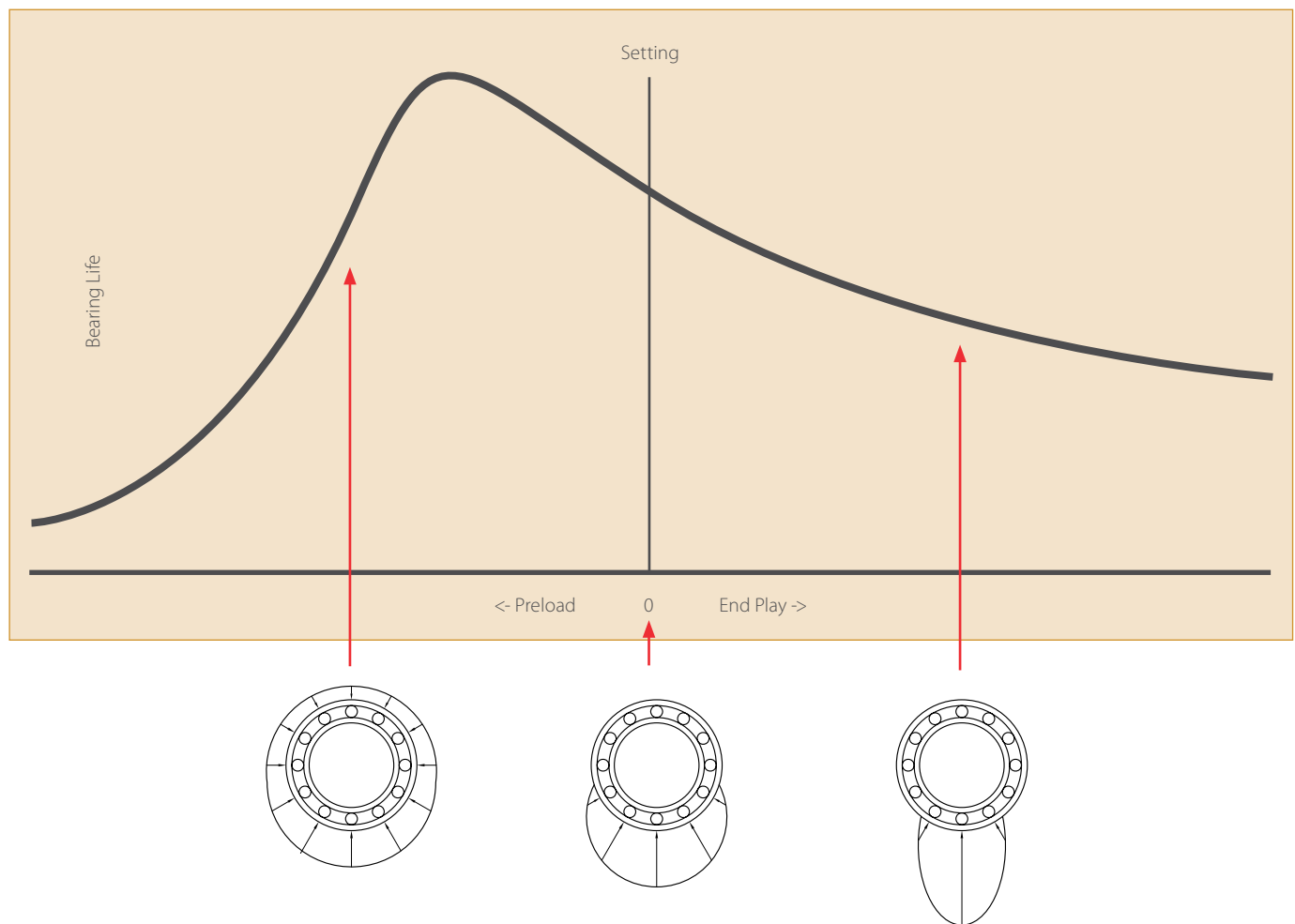

Figure A: Load distribution in a bearing with preload.

Figure B: Load distribution in a bearing with 0µm preload/0µm End Play.

Figure C: Load distribution in a bearing with end play.

As the end play within a tapered roller bearing is decreased, the load zone in the bearing increases because more rollers help support the loads. Preloading a tapered roller bearing will increase stiffness, improve shaft guidance, decrease noise/vibration, and under certain load conditions increase bearing life. PEER Engineers can help determine the appropriate setting for an application.

Part Numbering (Inch & J Prefix Metric)

For the basic part number, PEER follows the Inch series tapered roller bearing part numbering as specified by ABMA (American Bearing Manufacturers Association).

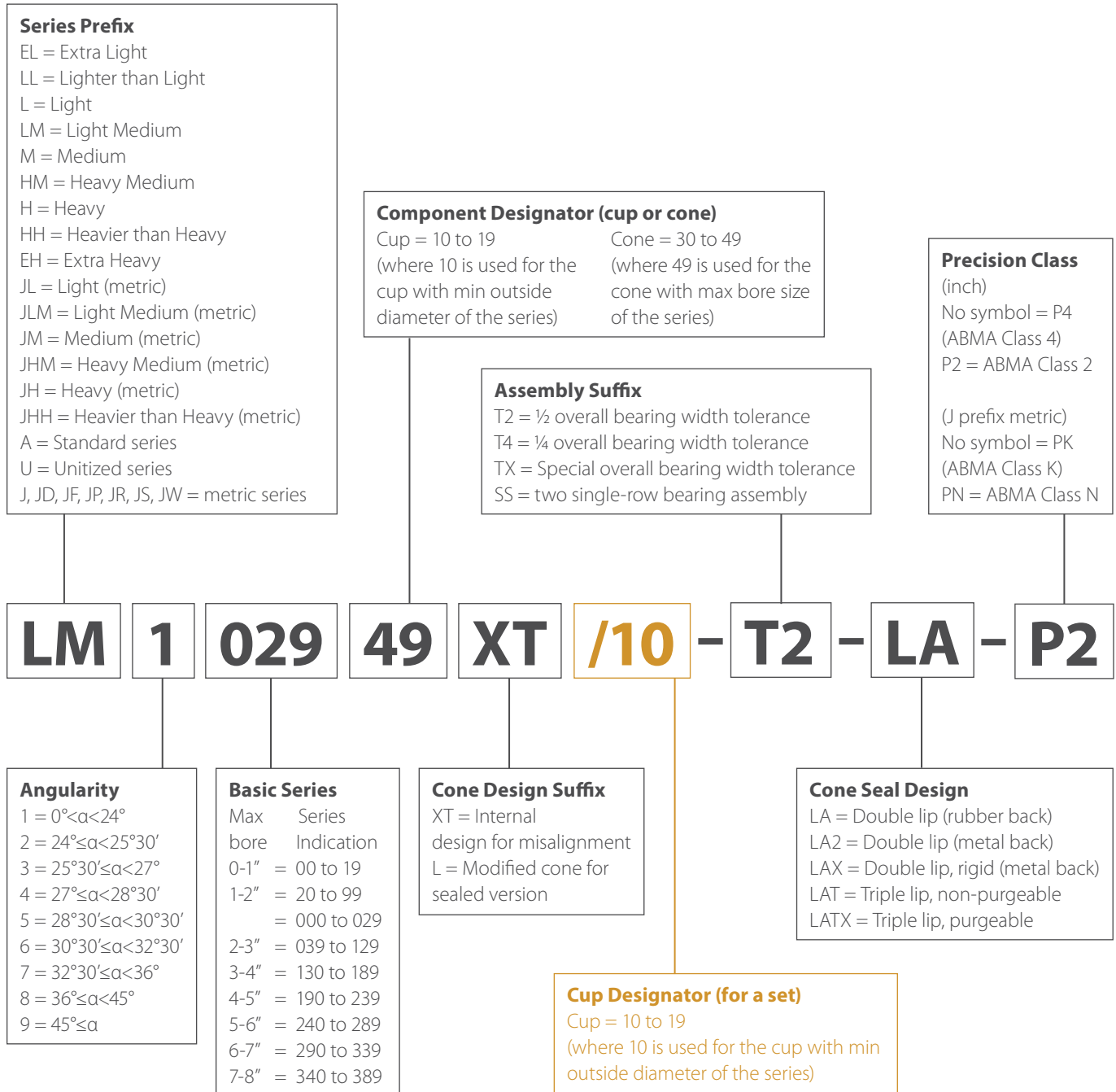

Part Numbering (ISO Metric)

For the basic part number, PEER follows the tapered roller bearing part numbering as specified by the ISO standard 15.

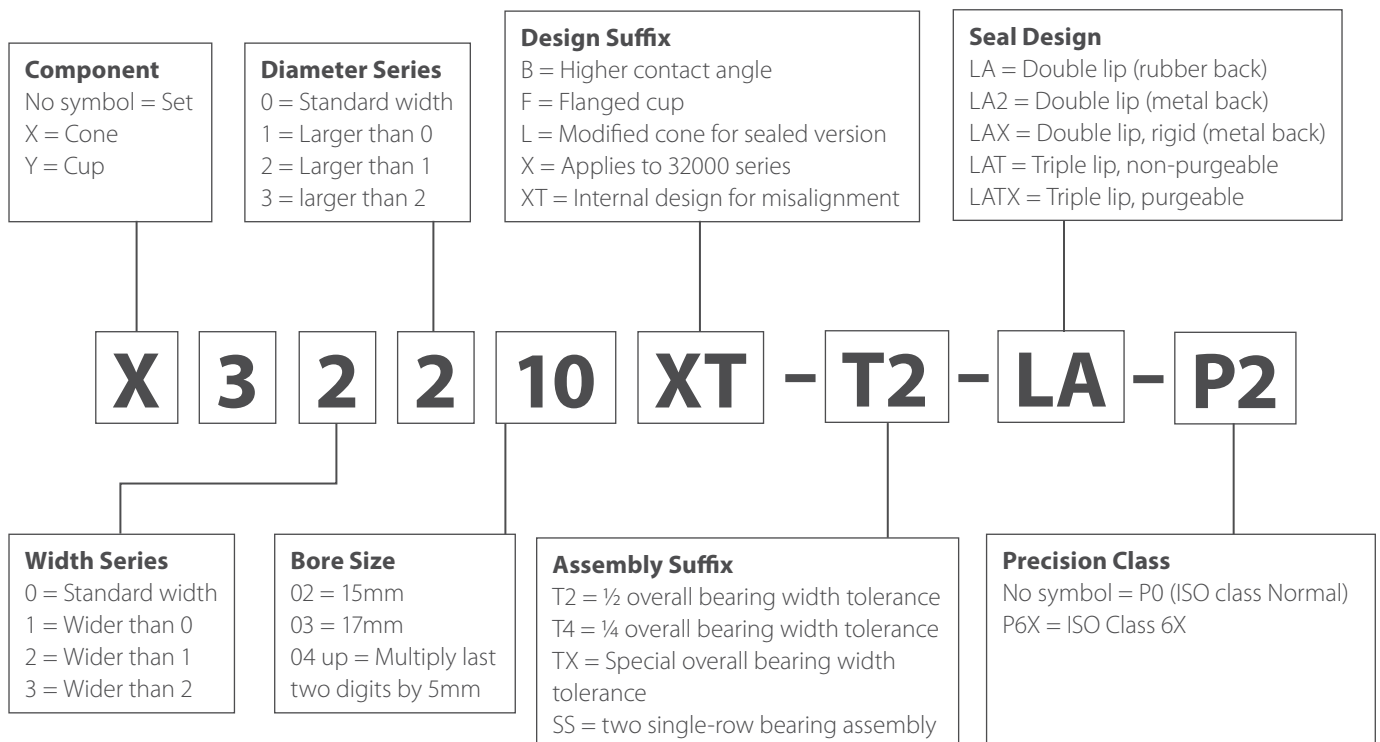

Custom Bearings

Any bearing size can be custom designed and manufactured by PEER.

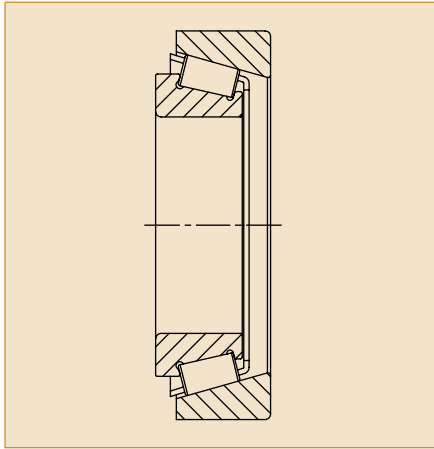

Extended Cup Backface

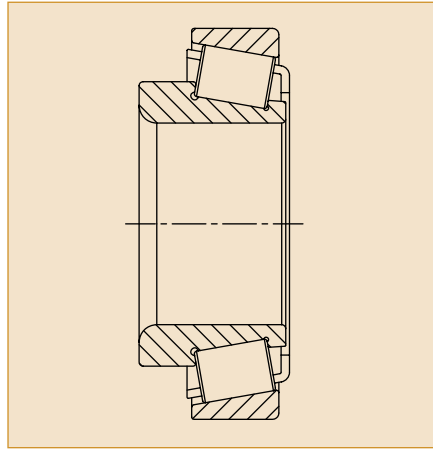

Extended Cone Backface

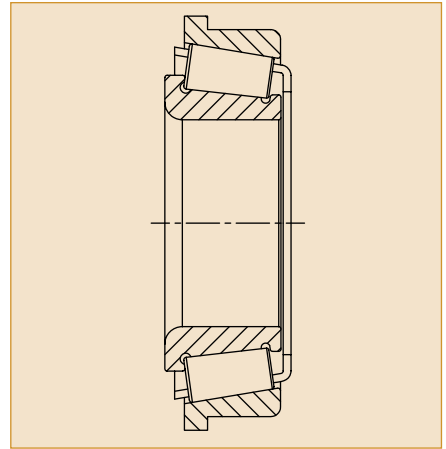

Flanged Cup

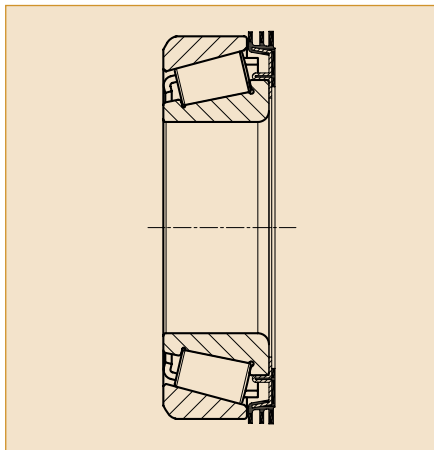

Triple Lip Sealed

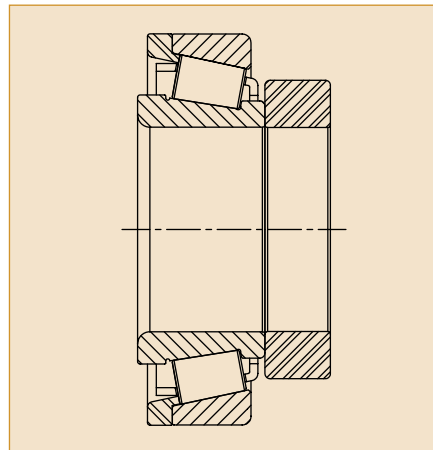

Unit Bearing

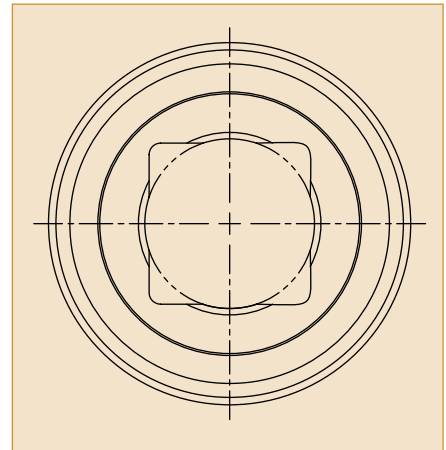

Square Bore

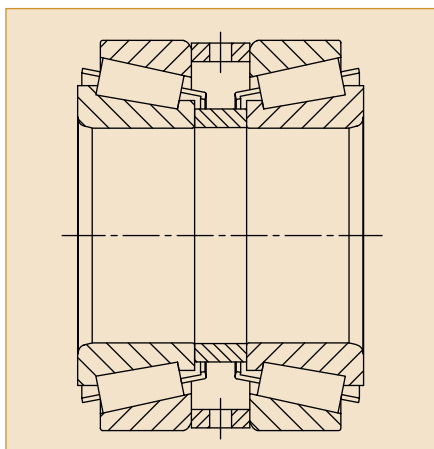

Spacer Assembly

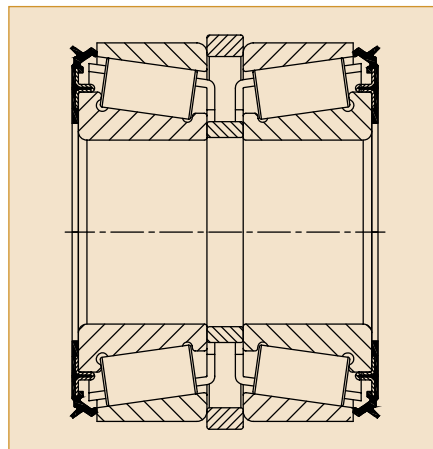

Sealed Spacer Assembly

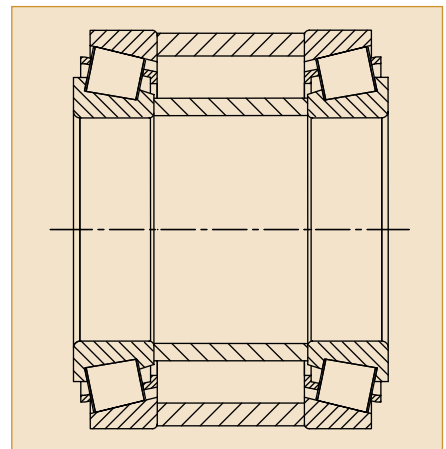

Extended Spacer Assembly

INCH TOLERANCES

Tolerances in μm and 0.0001 inch
Dimensions in mm and inches

Cone bore (d)		CLASS 4				CLASS 2			
		Cone bore tolerance Δ_d		Cone width tolerance Δ_B		Cone bore tolerance Δ_d		Cone width tolerance Δ_B	
Over	Incl.	high	low	high	low	high	low	high	low
--	76.2 3.0	+13 +5	0 0	+76 +30	-254 -100	+13 +5	0 0	+76 +30	-254 -100
76.2 3.0	304.8 12.0	+25 +10	0 0	+76 +30	-254 -100	+25 +10	0 0	+76 +30	-254 -100

Cup outside diameter (D)		CLASS 4				CLASS 2			
		Cup OD tolerance Δ_D		Cup width tolerance Δ_c		Cup OD tolerance Δ_D		Cup width tolerance Δ_c	
Over	Incl.	high	low	high	low	high	low	high	low
--	76.2 3.0	+25 +10	0 0	+51 +20	-254 -100	+25 +10	0 0	+51 +20	-254 -100
76.2 3.0	304.8 12.0	+25 +10	0 0	+51 +20	-254 -100	+25 +10	0 0	+51 +20	-254 -100

Cone bore (d)		CLASS 4				CLASS 2			
		Overall width tolerance Δ_T				Overall width tolerance Δ_T			
Over	Incl.	high		low		high		low	
--	101.6 4.0	+203 +80		0 0		+203 +80		0 0	
101.6 4.0	304.8 12.0	+356 +140		-254 -100		+203 +80		0 0	

Cup outside diameter (D)		CLASS 4				CLASS 2			
		Cone assembled radial runout K_{ia}		Cup assembled radial runout K_{ea}		Cone assembled radial runout K_{ia}		Cup assembled radial runout K_{ea}	
Over	Incl.	max		max		max		max	
--	101.6 4.0	+51 +2		+51 +2		+38 +15		+38 +15	
101.6 4.0	304.8 12.0	+51 +2		+51 +2		+38 +15		+38 +15	

J PREFIX METRIC TOLERANCES

Tolerances in μm and 0.0001 inch
Dimensions in mm and inches

Cone bore (d)		CLASS K			CLASS N		
		Cone bore tolerance Δ_d		Radial runout of assembled bearing cone Kia	Cone bore tolerance Δ_d		Radial runout of assembled bearing cone Kia
Over	Incl.	high	low	max	high	low	max
--	18 .7087	0 0	-12 -5	+15 +6	0 0	-12 -5	+15 +6
18 .7087	30 1.1811	0 0	-12 -5	+18 +7	0 0	-12 -5	+18 +7
30 1.1811	50 1.9685	0 0	-12 -5	+20 +8	0 0	-12 -5	+20 +8
50 1.9685	80 3.1496	0 0	-15 -6	+25 +10	0 0	-15 -6	+25 +10
80 3.1496	120 4.7244	0 0	-20 -8	+30 +12	0 0	-20 -8	+30 +12
120 4.7244	180 7.0866	0 0	-25 -10	+35 +14	0 0	-25 -10	+35 +14

Cup outside diameter (D)		CLASS K			CLASS N		
		Cup OD tolerance Δ_D		Radial runout of assembled bearing cup Kea	Cup OD tolerance Δ_D		Radial runout of assembled bearing cup Kea
Over	Incl.	high	low	max	high	low	max
--	30 1.1811	0 0	-12 -5	+18 +7	0 0	-12 -5	+18 +7
30 1.1811	50 1.9685	0 0	-14 -6	+20 +8	0 0	-14 -6	+20 +8
50 1.9685	80 3.1496	0 0	-16 -6	+25 +10	0 0	-16 -6	+25 +10
80 3.1496	120 4.7244	0 0	-18 -7	+35 +14	0 0	-18 -7	+35 +14
120 4.7244	150 5.9055	0 0	-20 -8	+40 +16	0 0	-20 -8	+40 +16
150 5.9055	180 7.0866	0 0	-25 -10	+45 +18	0 0	-25 -10	+45 +18
180 7.0866	250 9.8425	0 0	-30 -12	+50 +20	0 0	-30 -12	+50 +20
250 9.8425	315 12.4016	0 0	-35 -14	+60 +24	0 0	-35 -14	+60 +24

Cone bore (d)		CLASS K						CLASS N					
		Cone width tol. Δ_B		Cup width tol. Δ_C		Overall width tol. Δ_T		Cone width tol. Δ_B		Cup width tol. Δ_C		Overall width tol. Δ_T	
Over	Incl.	high	low	high	low	high	low	high	low	high	low	high	low
--	18 .7087	0 0	-100 -39	0 0	-120 -47	+200 +79	0 0	0 0	-50 -20	0 0	-100 -39	+100 +39	0 0
18 .7087	50 1.9685	0 0	-100 -39	0 0	-150 -59	+200 +79	0 0	0 0	-50 -20	0 0	-100 -39	+100 +39	0 0
50 1.9685	80 3.1496	0 0	-150 -59	0 0	-150 -59	+200 +79	0 0	0 0	-50 -20	0 0	-100 -39	+100 +39	0 0
80 3.1496	120 4.7244	0 0	-150 -59	0 0	-200 -79	+200 +79	-200 -79	0 0	-50 -20	0 0	-100 -39	+100 +39	0 0
120 4.7244	180 7.0866	0 0	-200 -79	0 0	-200 -79	+350 +138	-250 -98	0 0	-50 -20	0 0	-100 -39	+150 +59	0 0

ISO METRIC TOLERANCES

Tolerances in μm and 0.0001 inch
Dimensions in mm and inches

Cone bore (d)		CLASS Normal			CLASS 6X		
		Cone bore tolerance Δ_d		Radial runout of assembled bearing cone K_{ia}	Cone bore tolerance Δ_d		Radial runout of assembled bearing cone K_{ia}
Over	Incl.	high	low	max	high	low	max
--	18 .7087	0	-12 -5	+15 +6	0	-12 -5	+15 +6
18 .7087	30 1.1811	0	-12 -5	+18 +7	0	-12 -5	+18 +7
30 1.1811	50 1.9685	0	-12 -5	+20 +8	0	-12 -5	+20 +8
50 1.9685	80 3.1496	0	-15 -6	+25 +10	0	-15 -6	+25 +10
80 3.1496	120 4.7244	0	-20 -8	+30 +12	0	-20 -8	+30 +12
120 4.7244	180 7.0866	0	-25 -10	+35 +14	0	-25 -10	+35 +14

Cup outside diameter (D)		CLASS Normal			CLASS 6X		
		Cup OD tolerance Δ_D		Cup assembled radial runout K_{ea}	Cup OD tolerance Δ_D		Cup assembled radial runout K_{ea}
Over	Incl.	high	low	max	high	low	max
--	30 1.1811	0	-12 -5	+18 +7	0	-12 -5	+18 +7
30 1.1811	50 1.9685	0	-14 -6	+20 +8	0	-14 -6	+20 +8
50 1.9685	80 3.1496	0	-16 -6	+25 +10	0	-16 -6	+25 +10
80 3.1496	120 4.7244	0	-18 -7	+35 +14	0	-18 -7	+35 +14
120 4.7244	150 5.9055	0	-20 -8	+40 +16	0	-20 -8	+40 +16
150 5.9055	180 7.0866	0	-25 -10	+45 +18	0	-25 -10	+45 +18
180 7.0866	250 9.8425	0	-30 -12	+50 +20	0	-30 -12	+50 +20
250 9.8425	315 12.4016	0	-35 -14	+60 +24	0	-35 -14	+60 +24

Cone bore (d)		CLASS Normal						CLASS 6X					
		Cone width tol. Δ_B		Cup width tol. Δ_C		Overall width tol. Δ_T		Cone width tol. Δ_B		Cup width tol. Δ_C		Overall width tol. Δ_T	
Over	Incl.	high	low	high	low	high	low	high	low	high	low	high	low
--	50 1.9685	0	-120 -47	0	-120 -47	+200 +79	0	0	-50 -20	0	-100 -39	+100 +39	0
50 1.9685	80 3.1496	0	-150 -59	0	-150 -59	+200 +79	0	0	-50 -20	0	-100 -39	+100 +39	0
80 3.1496	120 4.7244	0	-200 -79	0	-200 -79	+200 +79	-200 -79	0	-50 -20	0	-100 -39	+100 +39	0
120 4.7244	180 7.0866	0	-250 -98	0	-250 -98	+350 +138	-250 -98	0	-50 -20	0	-100 -39	+150 +59	0

INCH FITTING PRACTICES

Inch Class: 4 and 2

Tolerances in μm
Dimensions in mm

"T" denotes a tight or interference fit, "L" denotes a loose or clearance fit

Cone bore (d)		Deviation from Nominal Cone Bore and Resultant Fit											
d (mm)		Tol. (μm)	Rotating Cone		Rotating or Stationary Cone		Stationary Cone						
			Ground seat		Unground or ground seat		Unground seat		Ground or unground seat		Hardened and ground seat		
			Moderate loads, no shock		Heavy loads, or high speed or shock		Moderate loads, no shock		Moderate loads, no shock, sheaves, wheels, idlers		Wheel spindles		
Over	Incl.			Shaft deviation	Resultant fit	Shaft deviation	Resultant fit	Shaft deviation	Resultant fit	Shaft deviation	Resultant fit	Shaft deviation	Resultant fit
--	76.2	0 +13	+38 +26	38T 13T	+64 +38	64T 25T	+13 0	13T 13L	0 -13	0 26L	-5 -18	5L 31L	
76.2	304.8	0 +25	+64 +38	64T 13T	Use heavy duty fitting practice. See Note		+25 0	25T 25L	0 -25	0 51L	-5 -18	5L 56L	

Note: For cone bores over 76.200mm (3.0000"), a minimum shaft deviation should be provided equal to the nominal cone bore plus 0.5 μm per 1.000 mm of cone bore. Add this value to the cone bore tolerance.

Cup OD		Deviation from nominal cup OD and resultant fit								
D (mm)		Tol. (μm)	Stationary Cup				Rotating or Stationary Cup		Rotating Cup	
			Floating or Clamped		Adjustable		Non-adjustable or in carriers, sheaves-clamped		Sheaves - unclamped	
			Housing bore deviation	Resultant fit	Housing bore deviation	Resultant fit	Housing bore deviation	Resultant fit	Housing bore deviation	Resultant fit
Over	Incl.									
--	76.2	0 +25	+50 +76	25L 76L	0 +25	25T 25L	-39 -13	64T 13T	-77 -51	102T 51T
76.2	127.0	0 +25	+50 +76	25L 76L	0 +25	25T 25L	-51 -25	76T 25T	-77 -51	102T 51T
127.0	304.8	0 +25	+50 +76	25L 76L	0 +51	25T 51L	-51 -25	76T 25T	-77 -51	102T 51T

ISO AND J PREFIX METRIC FITTING PRACTICES

(ISO Class: Normal and 6X, J Prefix Class: K and N)

Tolerances in μm
Dimensions in mm

“T” denotes a tight or interference fit, “L” denotes a loose or clearance fit

Cone bore			Deviation from Nominal Cup OD and Resultant Fit														
d (mm)		Tol. (μm)	Rotating Cone			Rotating or Stationary Cone			Stationary Cone								
			Ground seat			Unground or ground seat			Unground seat			Unground or ground seat			Hardened and ground seat		
			Constant loads with moderate shock			Heavy loads, or high speed or shock			Moderate loads, no shock			Moderate loads, no shock, sheaves, wheels, idlers			Wheel spindles		
Over	Incl.		Shaft deviation	Resultant fit	Symbol	Shaft deviation	Resultant fit	Symbol	Shaft deviation	Resultant fit	Symbol	Shaft deviation	Resultant fit	Symbol	Shaft deviation	Resultant fit	Symbol
10	18	0 -12	+18 +7	30T 7T	m6	+23 +12	35T 12T	n6	0 -11	12T 11L	h6	-6 -17	6T 17L	g6	-16 -27	4L 27L	f6
18	30	0 -12	+21 +8	33T 8T	m6	+28 +15	40T 15T	n6	0 -13	12T 13L	h6	-7 -20	5T 20L	g6	-20 -33	8L 33L	f6
30	50	0 -12	+25 +9	37T 9T	m6	+33 +17	45T 17T	n6	0 -16	12T 16L	h6	-9 -25	3T 25L	g6	-25 -41	13L 41L	f6
50	80	0 -15	+30 +11	45T 11T	m6	+39 +20	54T 20T	n6	0 -19	15T 19L	h6	-10 -29	5T 29L	g6	-30 -49	15L 49L	f6
80	120	0 -20	+35 +13	55T 13T	m6	+45 +23	65T 23T	n6	0 -22	20T 22L	h6	-12 -34	8T 34L	g6	-36 -58	16L 58L	f6
120	180	0 -25	+52 +27	77T 27T	n6	+68 +43	93T 43T	p6	0 -25	25T 25L	h6	-14 -39	11T 39L	g6	-43 -68	18L 68L	f6

Cup OD			Deviation from Nominal Cup OD and Resultant Fit														
D (mm)		Tol. (μm)	Stationary Cup									Rotating Cup					
			Floating or Clamped			Adjustable			Non-adjustable or in carriers			Non-adjustable or in carriers or sheaves - clamped			Sheaves - unclamped		
			Housing bore deviation	Resultant fit	Symbol	Housing bore deviation	Resultant fit	Symbol	Housing bore deviation	Resultant fit	Symbol	Housing bore deviation	Resultant fit	Symbol	Housing bore deviation	Resultant fit	Symbol
18	30	0 -12	+7 +28	7L 40L	G7	-9 +12	9T 24L	J7	-35 -14	35T 2T	P7	-41 -20	41T 8T	R7	-61 -28	61T 16T	R8
30	50	0 -14	+9 +34	9L 48L	G7	-11 +14	11T 28L	J7	-42 -17	42T 3T	P7	-50 -25	50T 11T	R7	-73 -34	73T 20T	R8
50	65	0	+10	10L	G7	-12	12T	J7	-51	51T	P7	-60	60T	R7	-90	90T	--
65	80	-16	+40	56L		+18	34L		-21	5T		-30	14T		-45	29T	
80	100	0	+12	12L	G7	-13	13T	J7	-59	59T	P7	-73	73T	R7	-100	100T	--
100	120	-18	+47	65L		+22	40L		-24	6T		-38	20T		-50	32T	
120	140	0	+14	14L	G7	-14	14T	J7	-68	68T	P7	-88	88T	R7	-115	115T	--
140	150	-20	+54	74L		+26	46L		-28	8T		-48	28T		-65	45T	
150	160	0	+14	14L	G7	-14	14T	J7	-68	68T	P7	-90	90T	R7	-115	115T	--
160	180	-25	+54	79L		+26	51L		-28	3T		-50	25T		-65	40T	
180	200	0	+15	15L	G7	-16	16T	J7	-79	79T	P7	-106	106T	R7	-125	125T	--
200	225	-30	+61	91L		+30	60L		-33	3T		-60	30T		-75	45T	
225	250											-109	109T				
250	280	0	+17	17L	G7	-16	16T	J7	-88	88T	P7	-113	113T	R7	-140	140T	--
280	315	-35	+69	104L		+36	71L		-36	1T		-67	37T		-90	55T	
												-126	126T				
												-74	39T				
												-130	130T				
												-78	43T				

INCH SERIES

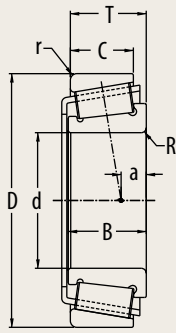

The tables include the most common industry series and sizes in the market. Additional industry series and sizes are available from PEER upon request.

Cone	Cup	d		B		R		D		C		r		T	
		Cone Bore		Cone Width		Max Shaft Radius		Cup Outer Diameter		Cup Width		Max Housing Radius		Total Width	
		mm	inch	mm	inch	mm	inch	mm	inch	mm	inch	mm	inch	mm	inch
335 SERIES															
335	332	34.925	1.3750	22.403	0.8820	0.8	0.03	80.000	3.1496	17.826	0.7018	1.3	0.05	21.000	0.8268
336	332	41.275	1.6250	22.403	0.8820	0.8	0.03	80.000	3.1496	17.826	0.7018	1.3	0.05	21.000	0.8268
339	332	35.000	1.3780	22.403	0.8820	0.8	0.03	80.000	3.1496	17.826	0.7018	1.3	0.05	21.000	0.8268
342	332	41.275	1.6250	22.403	0.8820	3.5	0.14	80.000	3.1496	17.826	0.7018	1.3	0.05	21.000	0.8268
342-S	332	42.875	1.6880	22.403	0.8820	3.5	0.14	80.000	3.1496	17.826	0.7018	1.3	0.05	21.000	0.8268
344	332	40.000	1.5748	22.403	0.8820	3.5	0.14	80.000	3.1496	17.826	0.7018	1.3	0.05	21.000	0.8268
344A	332	40.000	1.5748	22.403	0.8820	0.8	0.03	80.000	3.1496	17.826	0.7018	1.3	0.05	21.000	0.8268
342A	332	41.275	1.6250	29.977	1.1802	3.5	0.14	80.000	3.1496	17.826	0.7018	1.3	0.05	28.574	1.1250
335	332A	34.925	1.3750	22.403	0.8820	0.8	0.03	80.000	3.1496	21.000	0.8268	2.3	0.09	24.175	0.9518
336	332A	41.275	1.6250	22.403	0.8820	0.8	0.03	80.000	3.1496	21.000	0.8268	2.3	0.09	24.175	0.9518
339	332A	35.000	1.3780	22.403	0.8820	0.8	0.03	80.000	3.1496	21.000	0.8268	2.3	0.09	24.175	0.9518
342	332A	41.275	1.6250	22.403	0.8820	3.5	0.14	80.000	3.1496	21.000	0.8268	2.3	0.09	24.175	0.9518
342-S	332A	42.875	1.6880	22.403	0.8820	3.5	0.14	80.000	3.1496	21.000	0.8268	2.3	0.09	24.175	0.9518
344	332A	40.000	1.5748	22.403	0.8820	3.5	0.14	80.000	3.1496	21.000	0.8268	2.3	0.09	24.175	0.9518
344A	332A	40.000	1.5748	22.403	0.8820	0.8	0.03	80.000	3.1496	21.000	0.8268	2.3	0.09	24.175	0.9518
342A	332A	41.275	1.6250	29.977	1.1802	3.5	0.14	80.000	3.1496	21.000	0.8268	2.3	0.09	31.749	1.2500
355 SERIES															
350A	352	40.000	1.5748	21.692	0.8540	0.8	0.03	90.119	3.5480	21.808	0.8586	2.3	0.09	23.000	0.9055
355	352	44.450	1.7500	21.692	0.8540	2.3	0.09	90.119	3.5480	21.808	0.8586	2.3	0.09	23.000	0.9055
355X	352	44.450	1.7500	21.692	0.8540	3.5	0.14	90.119	3.5480	21.808	0.8586	2.3	0.09	23.000	0.9055
359-S	352	46.038	1.8125	21.692	0.8540	2.3	0.09	90.119	3.5480	21.808	0.8586	2.3	0.09	23.000	0.9055
359A	352	46.038	1.8125	21.692	0.8540	3.5	0.14	90.119	3.5480	21.808	0.8586	2.3	0.09	23.000	0.9055
350A	354A	40.000	1.5748	21.692	0.8540	0.8	0.03	85.000	3.3465	17.462	0.6875	1.3	0.05	20.635	0.8124
355	354A	44.450	1.7500	21.692	0.8540	2.3	0.09	85.000	3.3465	17.462	0.6875	1.3	0.05	20.635	0.8124
355X	354A	44.450	1.7500	21.692	0.8540	3.5	0.14	85.000	3.3465	17.462	0.6875	1.3	0.05	20.635	0.8124
359-S	354A	46.038	1.8125	21.692	0.8540	2.3	0.09	85.000	3.3465	17.462	0.6875	1.3	0.05	20.635	0.8124
359A	354A	46.038	1.8125	21.692	0.8540	3.5	0.14	85.000	3.3465	17.462	0.6875	1.3	0.05	20.635	0.8124
350A	354X	40.000	1.5748	21.692	0.8540	0.8	0.03	85.000	3.3465	17.462	0.6875	1.5	0.06	20.635	0.8124
355	354X	44.450	1.7500	21.692	0.8540	2.3	0.09	85.000	3.3465	17.462	0.6875	1.5	0.06	20.635	0.8124
355X	354X	44.450	1.7500	21.692	0.8540	3.5	0.14	85.000	3.3465	17.462	0.6875	1.5	0.06	20.635	0.8124
359-S	354X	46.038	1.8125	21.692	0.8540	2.3	0.09	85.000	3.3465	17.462	0.6875	1.5	0.06	20.635	0.8124
359A	354X	46.038	1.8125	21.692	0.8540	3.5	0.14	85.000	3.3465	17.462	0.6875	1.5	0.06	20.635	0.8124

$$P = X \cdot Fr + Y \cdot Fa$$

$\frac{Fa}{Fr} \leq e$		$\frac{Fa}{Fr} > e$	
X	Y	X	Y
1	0	0.40	See table

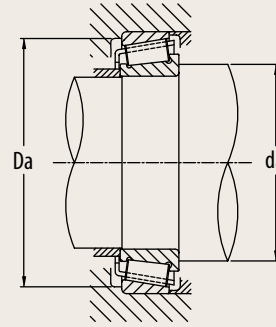

Cone	Cup	Basic Load Rating		a		e	Y Axial Load Factor	Da		da		Reference Speed RPM	Cone Weight Kg	Cup Weight Kg
		Dynamic Cr	Static Cor	Effective Load Center				Housing Bore ID		Shaft OD				
		KN	KN	mm	inch			mm	inch	mm	inch			
335 SERIES														
335	332	65.1	70.8	6.4	0.25	0.27	2.20	72	2.83	47	1.85	5500	0.390	0.144
336	332	65.1	70.8	6.4	0.25	0.27	2.20	72	2.83	50	1.97	5500	0.323	0.144
339	332	65.1	70.8	6.4	0.25	0.27	2.20	72	2.83	47	1.85	5500	0.389	0.144
342	332	65.1	70.8	6.4	0.25	0.27	2.20	72	2.83	52	2.05	5500	0.320	0.144
342-S	332	65.1	70.8	6.4	0.25	0.27	2.20	72	2.83	53	2.09	5500	0.301	0.144
344	332	65.1	70.8	6.4	0.25	0.27	2.20	72	2.83	52	2.05	5500	0.334	0.144
344A	332	65.1	70.8	6.4	0.25	0.27	2.20	72	2.83	49	1.93	5500	0.338	0.144
342A	332	65.1	70.8	13.9	0.55	0.27	2.20	72	2.83	52	2.05	5500	0.398	0.144
335	332A	65.1	70.8	6.4	0.25	0.27	2.20	72	2.83	47	1.85	5500	0.390	0.181
336	332A	65.1	70.8	6.4	0.25	0.27	2.20	72	2.83	50	1.97	5500	0.323	0.181
339	332A	65.1	70.8	6.4	0.25	0.27	2.20	72	2.83	47	1.85	5500	0.389	0.181
342	332A	65.1	70.8	6.4	0.25	0.27	2.20	72	2.83	52	2.05	5500	0.320	0.181
342-S	332A	65.1	70.8	6.4	0.25	0.27	2.20	72	2.83	53	2.09	5500	0.301	0.181
344	332A	65.1	70.8	6.4	0.25	0.27	2.20	72	2.83	52	2.05	5500	0.334	0.181
344A	332A	65.1	70.8	6.4	0.25	0.27	2.20	72	2.83	49	1.93	5500	0.338	0.181
342A	332A	65.1	70.8	13.9	0.55	0.27	2.20	72	2.83	52	2.05	5500	0.398	0.181
355 SERIES														
350A	352	67.1	75.6	4.9	0.19	0.31	1.96	78	3.07	51	2.01	5500	0.408	0.319
355	352	67.1	75.6	4.9	0.19	0.31	1.96	78	3.07	55	2.17	5500	0.357	0.319
355X	352	67.1	75.6	4.9	0.19	0.31	1.96	78	3.07	57	2.24	5500	0.354	0.319
359-S	352	67.1	75.6	4.9	0.19	0.31	1.96	78	3.07	56	2.20	5500	0.337	0.319
359A	352	67.1	75.6	4.9	0.19	0.31	1.96	78	3.07	57	2.24	5500	0.335	0.319
350A	354A	67.1	75.6	4.9	0.19	0.31	1.96	77	3.03	51	2.01	5500	0.408	0.161
355	354A	67.1	75.6	4.9	0.19	0.31	1.96	77	3.03	55	2.17	5500	0.357	0.161
355X	354A	67.1	75.6	4.9	0.19	0.31	1.96	77	3.03	57	2.24	5500	0.354	0.161
359-S	354A	67.1	75.6	4.9	0.19	0.31	1.96	77	3.03	56	2.20	5500	0.337	0.161
359A	354A	67.1	75.6	4.9	0.19	0.31	1.96	77	3.03	57	2.24	5500	0.335	0.161
350A	354X	67.1	75.6	4.9	0.19	0.31	1.96	77	3.03	51	2.01	5500	0.408	0.161
355	354X	67.1	75.6	4.9	0.19	0.31	1.96	77	3.03	55	2.17	5500	0.357	0.161
355X	354X	67.1	75.6	4.9	0.19	0.31	1.96	77	3.03	57	2.24	5500	0.354	0.161
359-S	354X	67.1	75.6	4.9	0.19	0.31	1.96	77	3.03	56	2.20	5500	0.337	0.161
359A	354X	67.1	75.6	4.9	0.19	0.31	1.96	77	3.03	57	2.24	5500	0.335	0.161

INCH SERIES

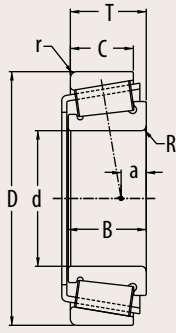

The tables include the most common industry series and sizes in the market. Additional industry series and sizes are available from PEER upon request.

Cone	Cup	d		B		R		D		C		r		T	
		Cone Bore		Cone Width		Max Shaft Radius		Cup Outer Diameter		Cup Width		Max Housing Radius		Total Width	
		mm	inch	mm	inch	mm	inch	mm	inch	mm	inch	mm	inch	mm	inch
365 SERIES															
366	362	50.000	1.9685	22.225	0.8750	2.3	0.09	90.000	3.5433	15.875	0.6250	2.0	0.08	20.000	0.7874
368	362	50.800	2.0000	22.225	0.8750	1.5	0.06	90.000	3.5433	15.875	0.6250	2.0	0.08	20.000	0.7874
368-S	362	51.592	2.0312	22.225	0.8750	2.0	0.08	90.000	3.5433	15.875	0.6250	2.0	0.08	20.000	0.7874
368A	362	50.800	2.0000	22.225	0.8750	3.5	0.14	90.000	3.5433	15.875	0.6250	2.0	0.08	20.000	0.7874
369-S	362	47.625	1.8750	22.225	0.8750	2.3	0.09	90.000	3.5433	15.875	0.6250	2.0	0.08	20.000	0.7874
369A	362	47.625	1.8750	22.225	0.8750	3.5	0.14	90.000	3.5433	15.875	0.6250	2.0	0.08	20.000	0.7874
370A	362	50.800	2.0000	22.225	0.8750	5.0	0.20	90.000	3.5433	15.875	0.6250	2.0	0.08	20.000	0.7874
366	362A	50.000	1.9685	22.225	0.8750	2.3	0.09	88.900	3.5000	16.513	0.6501	1.3	0.05	20.637	0.8125
368	362A	50.800	2.0000	22.225	0.8750	1.5	0.06	88.900	3.5000	16.513	0.6501	1.3	0.05	20.637	0.8125
368-S	362A	51.592	2.0312	22.225	0.8750	2.0	0.08	88.900	3.5000	16.513	0.6501	1.3	0.05	20.637	0.8125
368A	362A	50.800	2.0000	22.225	0.8750	3.5	0.14	88.900	3.5000	16.513	0.6501	1.3	0.05	20.637	0.8125
369-S	362A	47.625	1.8750	22.225	0.8750	2.3	0.09	88.900	3.5000	16.513	0.6501	1.3	0.05	20.637	0.8125
369A	362A	47.625	1.8750	22.225	0.8750	3.5	0.14	88.900	3.5000	16.513	0.6501	1.3	0.05	20.637	0.8125
370A	362A	50.800	2.0000	22.225	0.8750	5.0	0.20	88.900	3.5000	16.513	0.6501	1.3	0.05	20.637	0.8125
366	362X	50.000	1.9685	22.225	0.8750	2.3	0.09	90.000	3.5433	20.000	0.7874	2.0	0.08	25.000	0.9843
368	362X	50.800	2.0000	22.225	0.8750	1.5	0.06	90.000	3.5433	20.000	0.7874	2.0	0.08	25.000	0.9843
368-S	362X	51.592	2.0312	22.225	0.8750	2.0	0.08	90.000	3.5433	20.000	0.7874	2.0	0.08	25.000	0.9843
368A	362X	50.800	2.0000	22.225	0.8750	3.5	0.14	90.000	3.5433	20.000	0.7874	2.0	0.08	25.000	0.9843
369-S	362X	47.625	1.8750	22.225	0.8750	2.3	0.09	90.000	3.5433	20.000	0.7874	2.0	0.08	25.000	0.9843
369A	362X	47.625	1.8750	22.225	0.8750	3.5	0.14	90.000	3.5433	20.000	0.7874	2.0	0.08	25.000	0.9843
370A	362X	50.800	2.0000	22.225	0.8750	5.0	0.20	90.000	3.5433	20.000	0.7874	2.0	0.08	25.000	0.9843
366	363	50.000	1.9685	22.225	0.8750	2.3	0.09	90.000	3.5433	20.000	0.7874	0.8	0.03	20.000	0.7874
368	363	50.800	2.0000	22.225	0.8750	1.5	0.06	90.000	3.5433	20.000	0.7874	0.8	0.03	20.000	0.7874
368-S	363	51.592	2.0312	22.225	0.8750	2.0	0.08	90.000	3.5433	20.000	0.7874	0.8	0.03	20.000	0.7874
368A	363	50.800	2.0000	22.225	0.8750	3.5	0.14	90.000	3.5433	20.000	0.7874	0.8	0.03	20.000	0.7874
369-S	363	47.625	1.8750	22.225	0.8750	2.3	0.09	90.000	3.5433	20.000	0.7874	0.8	0.03	20.000	0.7874
369A	363	47.625	1.8750	22.225	0.8750	3.5	0.14	90.000	3.5433	20.000	0.7874	0.8	0.03	20.000	0.7874
370A	363	50.800	2.0000	22.225	0.8750	5.0	0.20	90.000	3.5433	20.000	0.7874	0.8	0.03	20.000	0.7874
385 SERIES															
385	382	55.000	2.1654	21.946	0.8640	2.3	0.09	98.425	3.8750	17.826	0.7018	0.8	0.03	21.000	0.8268
385A	382	50.800	2.0000	21.946	0.8640	2.3	0.09	98.425	3.8750	17.826	0.7018	0.8	0.03	21.000	0.8268
385X	382	55.000	2.1654	21.946	0.8640	3.5	0.14	98.425	3.8750	17.826	0.7018	0.8	0.03	21.000	0.8268
386A	382	47.625	1.8750	21.946	0.8640	0.8	0.03	98.425	3.8750	17.826	0.7018	0.8	0.03	21.000	0.8268

$$P = X \cdot Fr + Y \cdot Fa$$

$\frac{Fa}{Fr} \leq e$		$\frac{Fa}{Fr} > e$	
X	Y	X	Y
1	0	0.40	See table

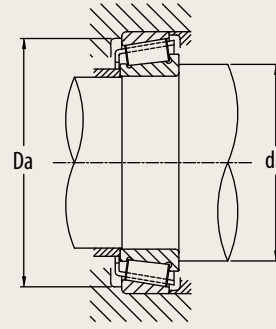

Cone	Cup	Basic Load Rating		a		e	Y Axial Load Factor	Da		da		Reference Speed RPM	Cone Weight Kg	Cup Weight Kg
		Dynamic Cr	Static Cor	Effective Load Center				Housing Bore ID		Shaft OD				
		KN	KN	mm	inch			mm	inch	mm	inch			
365 SERIES														
366	362	71.1	82.3	4.1	0.16	0.32	1.88	81	3.19	60	2.36	5000	0.359	0.173
368	362	71.1	82.3	4.1	0.16	0.32	1.88	81	3.19	60	2.36	5000	0.349	0.173
368-S	362	71.1	82.3	4.1	0.16	0.32	1.88	81	3.19	60	2.36	5000	0.345	0.173
368A	362	71.1	82.3	4.1	0.16	0.32	1.88	81	3.19	62	2.44	5000	0.345	0.173
369-S	362	71.1	82.3	4.1	0.16	0.32	1.88	81	3.19	59	2.32	5000	0.390	0.173
369A	362	71.1	82.3	4.1	0.16	0.32	1.88	81	3.19	60	2.36	5000	0.387	0.173
370A	362	71.1	82.3	4.1	0.16	0.32	1.88	81	3.19	63	2.48	5000	0.340	0.173
366	362A	71.1	82.3	4.1	0.16	0.32	1.88	81	3.19	60	2.36	5000	0.359	0.165
368	362A	71.1	82.3	4.1	0.16	0.32	1.88	81	3.19	60	2.36	5000	0.349	0.165
368-S	362A	71.1	82.3	4.1	0.16	0.32	1.88	81	3.19	60	2.36	5000	0.345	0.165
368A	362A	71.1	82.3	4.1	0.16	0.32	1.88	81	3.19	62	2.44	5000	0.345	0.165
369-S	362A	71.1	82.3	4.1	0.16	0.32	1.88	81	3.19	59	2.32	5000	0.390	0.165
369A	362A	71.1	82.3	4.1	0.16	0.32	1.88	81	3.19	60	2.36	5000	0.387	0.165
370A	362A	71.1	82.3	4.1	0.16	0.32	1.88	81	3.19	63	2.48	5000	0.340	0.165
366	362X	71.1	82.3	4.1	0.16	0.32	1.88	81	3.19	60	2.36	5000	0.359	0.243
368	362X	71.1	82.3	4.1	0.16	0.32	1.88	81	3.19	60	2.36	5000	0.349	0.243
368-S	362X	71.1	82.3	4.1	0.16	0.32	1.88	81	3.19	60	2.36	5000	0.345	0.243
368A	362X	71.1	82.3	4.1	0.16	0.32	1.88	81	3.19	62	2.44	5000	0.345	0.243
369-S	362X	71.1	82.3	4.1	0.16	0.32	1.88	81	3.19	59	2.32	5000	0.390	0.243
369A	362X	71.1	82.3	4.1	0.16	0.32	1.88	81	3.19	60	2.36	5000	0.387	0.243
370A	362X	71.1	82.3	4.1	0.16	0.32	1.88	81	3.19	63	2.48	5000	0.340	0.243
366	363	71.1	82.3	4.1	0.16	0.32	1.88	82	3.23	60	2.36	5000	0.359	0.205
368	363	71.1	82.3	4.1	0.16	0.32	1.88	82	3.23	60	2.36	5000	0.349	0.205
368-S	363	71.1	82.3	4.1	0.16	0.32	1.88	82	3.23	60	2.36	5000	0.345	0.205
368A	363	71.1	82.3	4.1	0.16	0.32	1.88	82	3.23	62	2.44	5000	0.345	0.205
369-S	363	71.1	82.3	4.1	0.16	0.32	1.88	82	3.23	59	2.32	5000	0.390	0.205
369A	363	71.1	82.3	4.1	0.16	0.32	1.88	82	3.23	60	2.36	5000	0.387	0.205
370A	363	71.1	82.3	4.1	0.16	0.32	1.88	82	3.23	63	2.48	5000	0.340	0.205
385 SERIES														
385	382	77.2	95	3.0	0.12	0.35	1.69	90	3.54	67	2.64	4500	0.451	0.225
385A	382	77.2	95	3.0	0.12	0.35	1.69	90	3.54	65	2.56	4500	0.511	0.225
385X	382	77.2	95	3.0	0.12	0.35	1.69	90	3.54	68	2.68	4500	0.448	0.225
386A	382	77.2	95	3.0	0.12	0.35	1.69	90	3.54	62	2.44	4500	0.555	0.225

INCH SERIES

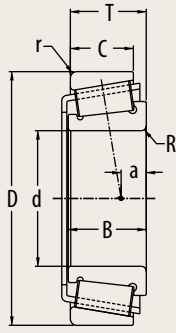

The tables include the most common industry series and sizes in the market. Additional industry series and sizes are available from PEER upon request.

Cone	Cup	d		B		R		D		C		r		T	
		Cone Bore		Cone Width		Max Shaft Radius		Cup Outer Diameter		Cup Width		Max Housing Radius		Total Width	
		mm	inch	mm	inch	mm	inch	mm	inch	mm	inch	mm	inch	mm	inch
385 SERIES (cont.)															
387	382	57.150	2.2500	21.946	0.8640	2.3	0.09	98.425	3.8750	17.826	0.7018	0.8	0.03	21.000	0.8268
387-S	382	57.150	2.2500	21.946	0.8640	0.8	0.03	98.425	3.8750	17.826	0.7018	0.8	0.03	21.000	0.8268
387A	382	57.150	2.2500	21.946	0.8640	3.5	0.14	98.425	3.8750	17.826	0.7018	0.8	0.03	21.000	0.8268
387AS	382	57.150	2.2500	21.946	0.8640	5.2	0.20	98.425	3.8750	17.826	0.7018	0.8	0.03	21.000	0.8268
388A	382	57.531	2.2650	21.946	0.8640	3.5	0.14	98.425	3.8750	17.826	0.7018	0.8	0.03	21.000	0.8268
389	382	55.575	2.1880	21.946	0.8640	2.3	0.09	98.425	3.8750	17.826	0.7018	0.8	0.03	21.000	0.8268
385	382A	55.000	2.1654	21.946	0.8640	2.3	0.09	96.838	3.8125	15.875	0.6250	0.8	0.03	21.000	0.8268
385A	382A	50.800	2.0000	21.946	0.8640	2.3	0.09	96.838	3.8125	15.875	0.6250	0.8	0.03	21.000	0.8268
385X	382A	55.000	2.1654	21.946	0.8640	3.5	0.14	96.838	3.8125	15.875	0.6250	0.8	0.03	21.000	0.8268
386A	382A	47.625	1.8750	21.946	0.8640	0.8	0.03	96.838	3.8125	15.875	0.6250	0.8	0.03	21.000	0.8268
387	382A	57.150	2.2500	21.946	0.8640	2.3	0.09	96.838	3.8125	15.875	0.6250	0.8	0.03	21.000	0.8268
387-S	382A	57.150	2.2500	21.946	0.8640	0.8	0.03	96.838	3.8125	15.875	0.6250	0.8	0.03	21.000	0.8268
387A	382A	57.150	2.2500	21.946	0.8640	3.5	0.14	96.838	3.8125	15.875	0.6250	0.8	0.03	21.000	0.8268
387AS	382A	57.150	2.2500	21.946	0.8640	5.2	0.20	96.838	3.8125	15.875	0.6250	0.8	0.03	21.000	0.8268
388A	382A	57.531	2.2650	21.946	0.8640	3.5	0.14	96.838	3.8125	15.875	0.6250	0.8	0.03	21.000	0.8268
389	382A	55.575	2.1880	21.946	0.8640	2.3	0.09	96.838	3.8125	15.875	0.6250	0.8	0.03	21.000	0.8268
385	382-S	55.000	2.1654	21.946	0.8640	2.3	0.09	96.838	3.8125	20.274	0.7982	2.3	0.09	25.400	1.0000
385A	382-S	50.800	2.0000	21.946	0.8640	2.3	0.09	96.838	3.8125	20.274	0.7982	2.3	0.09	25.400	1.0000
385X	382-S	55.000	2.1654	21.946	0.8640	3.5	0.14	96.838	3.8125	20.274	0.7982	2.3	0.09	25.400	1.0000
386A	382-S	47.625	1.8750	21.946	0.8640	0.8	0.03	96.838	3.8125	20.274	0.7982	2.3	0.09	25.400	1.0000
387	382-S	57.150	2.2500	21.946	0.8640	2.3	0.09	96.838	3.8125	20.274	0.7982	2.3	0.09	25.400	1.0000
387-S	382-S	57.150	2.2500	21.946	0.8640	0.8	0.03	96.838	3.8125	20.274	0.7982	2.3	0.09	25.400	1.0000
387A	382-S	57.150	2.2500	21.946	0.8640	3.5	0.14	96.838	3.8125	20.274	0.7982	2.3	0.09	25.400	1.0000
387AS	382-S	57.150	2.2500	21.946	0.8640	5.2	0.20	96.838	3.8125	20.274	0.7982	2.3	0.09	25.400	1.0000
388A	382-S	57.531	2.2650	21.946	0.8640	3.5	0.14	96.838	3.8125	20.274	0.7982	2.3	0.09	25.400	1.0000
389	382-S	55.575	2.1880	21.946	0.8640	2.3	0.09	96.838	3.8125	20.274	0.7982	2.3	0.09	25.400	1.0000
385	383A	55.000	2.1654	21.946	0.8640	2.3	0.09	100.000	3.9370	17.826	0.7018	2.0	0.08	21.000	0.8268
385A	383A	50.800	2.0000	21.946	0.8640	2.3	0.09	100.000	3.9370	17.826	0.7018	2.0	0.08	21.000	0.8268
385X	383A	55.000	2.1654	21.946	0.8640	3.5	0.14	100.000	3.9370	17.826	0.7018	2.0	0.08	21.000	0.8268
386A	383A	47.625	1.8750	21.946	0.8640	0.8	0.03	100.000	3.9370	17.826	0.7018	2.0	0.08	21.000	0.8268
387	383A	57.150	2.2500	21.946	0.8640	2.3	0.09	100.000	3.9370	17.826	0.7018	2.0	0.08	21.000	0.8268
387-S	383A	57.150	2.2500	21.946	0.8640	0.8	0.03	100.000	3.9370	17.826	0.7018	2.0	0.08	21.000	0.8268
387A	383A	57.150	2.2500	21.946	0.8640	3.5	0.14	100.000	3.9370	17.826	0.7018	2.0	0.08	21.000	0.8268

$$P = X \cdot Fr + Y \cdot Fa$$

$\frac{Fa}{Fr} \leq e$		$\frac{Fa}{Fr} > e$	
X	Y	X	Y
1	0	0.40	See table

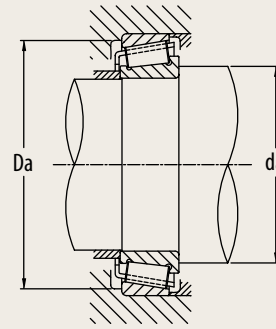

Cone	Cup	Basic Load Rating		a		e	Y Axial Load Factor	Da		da		Reference Speed RPM	Cone Weight Kg	Cup Weight Kg
		Dynamic Cr	Static Cor	Effective Load Center				Housing Bore ID		Shaft OD				
		KN	KN	mm	inch			mm	inch	mm	inch			
385 SERIES														
387	382	77.2	95	3.0	0.12	0.35	1.69	90	3.54	68	2.68	4500	0.419	0.225
387-S	382	77.2	95	3.0	0.12	0.35	1.69	90	3.54	66	2.60	4500	0.421	0.225
387A	382	77.2	95	3.0	0.12	0.35	1.69	90	3.54	69	2.72	4500	0.416	0.225
387AS	382	77.2	95	3.0	0.12	0.35	1.69	90	3.54	71	2.80	4500	0.409	0.225
388A	382	77.2	95	3.0	0.12	0.35	1.69	90	3.54	69	2.72	4500	0.410	0.225
389	382	77.2	95	3.0	0.12	0.35	1.69	90	3.54	67	2.64	4500	0.443	0.225
385	382A	77.2	95	3.0	0.12	0.35	1.69	89	3.50	67	2.64	4500	0.451	0.178
385A	382A	77.2	95	3.0	0.12	0.35	1.69	89	3.50	65	2.56	4500	0.511	0.178
385X	382A	77.2	95	3.0	0.12	0.35	1.69	89	3.50	68	2.68	4500	0.448	0.178
386A	382A	77.2	95	3.0	0.12	0.35	1.69	89	3.50	62	2.44	4500	0.555	0.178
387	382A	77.2	95	3.0	0.12	0.35	1.69	89	3.50	68	2.68	4500	0.419	0.178
387-S	382A	77.2	95	3.0	0.12	0.35	1.69	89	3.50	66	2.60	4500	0.421	0.178
387A	382A	77.2	95	3.0	0.12	0.35	1.69	89	3.50	69	2.72	4500	0.416	0.178
387AS	382A	77.2	95	3.0	0.12	0.35	1.69	89	3.50	71	2.80	4500	0.409	0.178
388A	382A	77.2	95	3.0	0.12	0.35	1.69	89	3.50	69	2.72	4500	0.410	0.178
389	382A	77.2	95	3.0	0.12	0.35	1.69	89	3.50	67	2.64	4500	0.443	0.178
385	382-S	77.2	95	3.0	0.12	0.35	1.69	86	3.39	67	2.64	4500	0.451	0.245
385A	382-S	77.2	95	3.0	0.12	0.35	1.69	86	3.39	65	2.56	4500	0.511	0.245
385X	382-S	77.2	95	3.0	0.12	0.35	1.69	86	3.39	68	2.68	4500	0.448	0.245
386A	382-S	77.2	95	3.0	0.12	0.35	1.69	86	3.39	62	2.44	4500	0.555	0.245
387	382-S	77.2	95	3.0	0.12	0.35	1.69	86	3.39	68	2.68	4500	0.419	0.245
387-S	382-S	77.2	95	3.0	0.12	0.35	1.69	86	3.39	66	2.60	4500	0.421	0.245
387A	382-S	77.2	95	3.0	0.12	0.35	1.69	86	3.39	69	2.72	4500	0.416	0.245
387AS	382-S	77.2	95	3.0	0.12	0.35	1.69	86	3.39	71	2.80	4500	0.409	0.245
388A	382-S	77.2	95	3.0	0.12	0.35	1.69	86	3.39	69	2.72	4500	0.410	0.245
389	382-S	77.2	95	3.0	0.12	0.35	1.69	86	3.39	67	2.64	4500	0.443	0.245
385	383A	77.2	95	3.0	0.12	0.35	1.69	89	3.50	67	2.64	4500	0.451	0.256
385A	383A	77.2	95	3.0	0.12	0.35	1.69	89	3.50	65	2.56	4500	0.511	0.256
385X	383A	77.2	95	3.0	0.12	0.35	1.69	89	3.50	68	2.68	4500	0.448	0.256
386A	383A	77.2	95	3.0	0.12	0.35	1.69	89	3.50	62	2.44	4500	0.555	0.256
387	383A	77.2	95	3.0	0.12	0.35	1.69	89	3.50	68	2.68	4500	0.419	0.256
387-S	383A	77.2	95	3.0	0.12	0.35	1.69	89	3.50	66	2.60	4500	0.421	0.256
387A	383A	77.2	95	3.0	0.12	0.35	1.69	89	3.50	69	2.72	4500	0.416	0.256

INCH SERIES

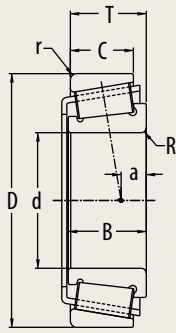

The tables include the most common industry series and sizes in the market. Additional industry series and sizes are available from PEER upon request.

Cone	Cup	d		B		R		D		C		r		T	
		Cone Bore		Cone Width		Max Shaft Radius		Cup Outer Diameter		Cup Width		Max Housing Radius		Total Width	
		mm	inch	mm	inch	mm	inch	mm	inch	mm	inch	mm	inch	mm	inch
385 SERIES (cont.)															
387AS	383A	57.150	2.2500	21.946	0.8640	5.2	0.20	100.000	3.9370	17.826	0.7018	2.0	0.08	21.000	0.8268
388A	383A	57.531	2.2650	21.946	0.8640	3.5	0.14	100.000	3.9370	17.826	0.7018	2.0	0.08	21.000	0.8268
389	383A	55.575	2.1880	21.946	0.8640	2.3	0.09	100.000	3.9370	17.826	0.7018	2.0	0.08	21.000	0.8268
395 SERIES															
390	393	57.150	2.2500	21.996	0.8660	2.3	0.09	110.000	4.3307	27.000	1.0630	0.8	0.03	27.000	1.0630
395	393	63.500	2.5000	21.996	0.8660	3.5	0.14	110.000	4.3307	27.000	1.0630	0.8	0.03	27.000	1.0630
395A	393	66.675	2.6250	21.996	0.8660	0.8	0.03	110.000	4.3307	27.000	1.0630	0.8	0.03	27.000	1.0630
396	393	50.000	1.9685	21.996	0.8660	0.8	0.03	110.000	4.3307	27.000	1.0630	0.8	0.03	27.000	1.0630
396-S	393	64.973	2.5580	21.996	0.8660	3.5	0.14	110.000	4.3307	27.000	1.0630	0.8	0.03	27.000	1.0630
399A	393	68.262	2.6875	21.996	0.8660	2.3	0.09	110.000	4.3307	27.000	1.0630	0.8	0.03	27.000	1.0630
399AS	393	68.262	2.6875	21.996	0.8660	5.0	0.20	110.000	4.3307	27.000	1.0630	0.8	0.03	27.000	1.0630
390	393AS	57.150	2.2500	21.996	0.8660	2.3	0.09	111.125	4.3750	18.824	0.7411	1.3	0.05	22.000	0.8661
395	393AS	63.500	2.5000	21.996	0.8660	3.5	0.14	111.125	4.3750	18.824	0.7411	1.3	0.05	22.000	0.8661
395A	393AS	66.675	2.6250	21.996	0.8660	0.8	0.03	111.125	4.3750	18.824	0.7411	1.3	0.05	22.000	0.8661
396	393AS	50.000	1.9685	21.996	0.8660	0.8	0.03	111.125	4.3750	18.824	0.7411	1.3	0.05	22.000	0.8661
396-S	393AS	64.973	2.5580	21.996	0.8660	3.5	0.14	111.125	4.3750	18.824	0.7411	1.3	0.05	22.000	0.8661
399A	393AS	68.262	2.6875	21.996	0.8660	2.3	0.09	111.125	4.3750	18.824	0.7411	1.3	0.05	22.000	0.8661
399AS	393AS	68.262	2.6875	21.996	0.8660	5.0	0.20	111.125	4.3750	18.824	0.7411	1.3	0.05	22.000	0.8661
390	394A	57.150	2.2500	21.996	0.8660	2.3	0.09	110.000	4.3307	18.824	0.7411	1.3	0.05	22.000	0.8661
395	394A	63.500	2.5000	21.996	0.8660	3.5	0.14	110.000	4.3307	18.824	0.7411	1.3	0.05	22.000	0.8661
395A	394A	66.675	2.6250	21.996	0.8660	0.8	0.03	110.000	4.3307	18.824	0.7411	1.3	0.05	22.000	0.8661
396	394A	50.000	1.9685	21.996	0.8660	0.8	0.03	110.000	4.3307	18.824	0.7411	1.3	0.05	22.000	0.8661
396-S	394A	64.973	2.5580	21.996	0.8660	3.5	0.14	110.000	4.3307	18.824	0.7411	1.3	0.05	22.000	0.8661
399A	394A	68.262	2.6875	21.996	0.8660	2.3	0.09	110.000	4.3307	18.824	0.7411	1.3	0.05	22.000	0.8661
399AS	394A	68.262	2.6875	21.996	0.8660	5.0	0.20	110.000	4.3307	18.824	0.7411	1.3	0.05	22.000	0.8661
390	394AS	57.150	2.2500	21.996	0.8660	2.3	0.09	110.000	4.3307	18.824	0.7411	3.3	0.13	22.000	0.8661
395	394AS	63.500	2.5000	21.996	0.8660	3.5	0.14	110.000	4.3307	18.824	0.7411	3.3	0.13	22.000	0.8661
395A	394AS	66.675	2.6250	21.996	0.8660	0.8	0.03	110.000	4.3307	18.824	0.7411	3.3	0.13	22.000	0.8661
396	394AS	50.000	1.9685	21.996	0.8660	0.8	0.03	110.000	4.3307	18.824	0.7411	3.3	0.13	22.000	0.8661
396-S	394AS	64.973	2.5580	21.996	0.8660	3.5	0.14	110.000	4.3307	18.824	0.7411	3.3	0.13	22.000	0.8661
399A	394AS	68.262	2.6875	21.996	0.8660	2.3	0.09	110.000	4.3307	18.824	0.7411	3.3	0.13	22.000	0.8661
399AS	394AS	68.262	2.6875	21.996	0.8660	5.0	0.20	110.000	4.3307	18.824	0.7411	3.3	0.13	22.000	0.8661
390	3920	57.150	2.2500	21.996	0.8660	2.3	0.09	112.712	4.4375	23.812	0.9375	3.3	0.13	26.967	1.0617

$P = X \cdot Fr + Y \cdot Fa$			
$\frac{Fa}{Fr} \leq e$		$\frac{Fa}{Fr} > e$	
X	Y	X	Y
1	0	0.40	See table

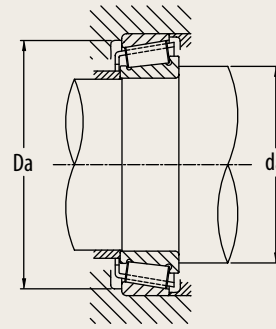

Cone	Cup	Basic Load Rating		a		e	Y Axial Load Factor	Da		da		Reference Speed RPM	Cone Weight Kg	Cup Weight Kg
		Dynamic Cr	Static Cor	Effective Load Center				Housing Bore ID	Shaft OD					
		KN	KN	mm	inch			mm	inch	mm	inch			
385 SERIES														
387AS	383A	77.2	95	3.0	0.12	0.35	1.69	89	3.50	71	2.80	4500	0.409	0.256
388A	383A	77.2	95	3.0	0.12	0.35	1.69	89	3.50	69	2.72	4500	0.410	0.256
389	383A	77.2	95	3.0	0.12	0.35	1.69	89	3.50	67	2.64	4500	0.443	0.256
395 SERIES														
390	393	82.5	108	0.5	0.02	0.40	1.49	101	3.98	70	2.76	3500	0.688	0.291
395	393	82.5	108	0.5	0.02	0.40	1.49	101	3.98	78	3.07	3500	0.581	0.291
395A	393	82.5	108	0.5	0.02	0.40	1.49	101	3.98	77	3.03	3500	0.531	0.291
396	393	82.5	108	0.5	0.02	0.40	1.49	101	3.98	69	2.72	3500	0.793	0.291
396-S	393	82.5	108	0.5	0.02	0.40	1.49	101	3.98	79	3.11	3500	0.555	0.291
399A	393	82.5	108	0.5	0.02	0.40	1.49	101	3.98	79	3.11	3500	0.500	0.291
399AS	393	82.5	108	0.5	0.02	0.40	1.49	101	3.98	82	3.23	3500	0.488	0.291
390	393AS	82.5	108	0.5	0.02	0.40	1.49	101	3.98	70	2.76	3500	0.688	0.290
395	393AS	82.5	108	0.5	0.02	0.40	1.49	101	3.98	78	3.07	3500	0.581	0.290
395A	393AS	82.5	108	0.5	0.02	0.40	1.49	101	3.98	77	3.03	3500	0.531	0.290
396	393AS	82.5	108	0.5	0.02	0.40	1.49	101	3.98	69	2.72	3500	0.793	0.290
396-S	393AS	82.5	108	0.5	0.02	0.40	1.49	101	3.98	79	3.11	3500	0.555	0.290
399A	393AS	82.5	108	0.5	0.02	0.40	1.49	101	3.98	79	3.11	3500	0.500	0.290
399AS	393AS	82.5	108	0.5	0.02	0.40	1.49	101	3.98	82	3.23	3500	0.488	0.290
390	394A	82.5	108	0.5	0.02	0.40	1.49	100	3.94	70	2.76	3500	0.688	0.261
395	394A	82.5	108	0.5	0.02	0.40	1.49	100	3.94	78	3.07	3500	0.581	0.261
395A	394A	82.5	108	0.5	0.02	0.40	1.49	100	3.94	77	3.03	3500	0.531	0.261
396	394A	82.5	108	0.5	0.02	0.40	1.49	100	3.94	69	2.72	3500	0.793	0.261
396-S	394A	82.5	108	0.5	0.02	0.40	1.49	100	3.94	79	3.11	3500	0.555	0.261
399A	394A	82.5	108	0.5	0.02	0.40	1.49	100	3.94	79	3.11	3500	0.500	0.261
399AS	394A	82.5	108	0.5	0.02	0.40	1.49	100	3.94	82	3.23	3500	0.488	0.261
390	394AS	82.5	108	0.5	0.02	0.40	1.49	98	3.86	70	2.76	3500	0.688	0.251
395	394AS	82.5	108	0.5	0.02	0.40	1.49	98	3.86	78	3.07	3500	0.581	0.251
395A	394AS	82.5	108	0.5	0.02	0.40	1.49	98	3.86	77	3.03	3500	0.531	0.251
396	394AS	82.5	108	0.5	0.02	0.40	1.49	98	3.86	69	2.72	3500	0.793	0.251
396-S	394AS	82.5	108	0.5	0.02	0.40	1.49	98	3.86	79	3.11	3500	0.555	0.251
399A	394AS	82.5	108	0.5	0.02	0.40	1.49	98	3.86	79	3.11	3500	0.500	0.251
399AS	394AS	82.5	108	0.5	0.02	0.40	1.49	98	3.86	82	3.23	3500	0.488	0.251
390	3920	82.5	108	0.5	0.02	0.40	1.49	98	3.86	70	2.76	3500	0.688	0.446

INCH SERIES

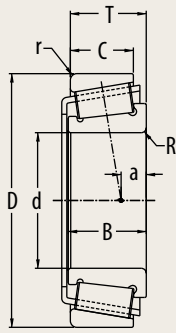

The tables include the most common industry series and sizes in the market. Additional industry series and sizes are available from PEER upon request.

Cone	Cup	d		B		R		D		C		r		T	
		Cone Bore		Cone Width		Max Shaft Radius		Cup Outer Diameter		Cup Width		Max Housing Radius		Total Width	
		mm	inch	mm	inch	mm	inch	mm	inch	mm	inch	mm	inch	mm	inch
395 SERIES (cont.)															
395	3920	63.500	2.5000	21.996	0.8660	3.5	0.14	112.712	4.4375	23.812	0.9375	3.3	0.13	26.967	1.0617
395A	3920	66.675	2.6250	21.996	0.8660	0.8	0.03	112.712	4.4375	23.812	0.9375	3.3	0.13	26.967	1.0617
396	3920	50.000	1.9685	21.996	0.8660	0.8	0.03	112.712	4.4375	23.812	0.9375	3.3	0.13	26.967	1.0617
396-S	3920	64.973	2.5580	21.996	0.8660	3.5	0.14	112.712	4.4375	23.812	0.9375	3.3	0.13	26.967	1.0617
399A	3920	68.262	2.6875	21.996	0.8660	2.3	0.09	112.712	4.4375	23.812	0.9375	3.3	0.13	26.967	1.0617
399AS	3920	68.262	2.6875	21.996	0.8660	5.0	0.20	112.712	4.4375	23.812	0.9375	3.3	0.13	26.967	1.0617
415 SERIES															
418	414	38.100	1.5000	29.083	1.1450	3.5	0.14	88.500	3.4843	22.225	0.8750	1.5	0.06	26.988	1.0625
420	414	40.000	1.5748	29.083	1.1450	3.5	0.14	88.500	3.4843	22.225	0.8750	1.5	0.06	26.988	1.0625
435 SERIES															
438	432A	44.450	1.7500	29.900	1.1772	3.5	0.14	95.250	3.7500	22.225	0.8750	0.8	0.03	27.783	1.0938
443	432A	31.750	1.2500	29.900	1.1772	0.8	0.03	95.250	3.7500	22.225	0.8750	0.8	0.03	27.783	1.0938
455 SERIES															
455	453	50.800	2.0000	29.317	1.1542	0.8	0.03	107.950	4.2500	27.000	1.0630	0.8	0.03	27.795	1.0943
460	453	44.450	1.7500	29.317	1.1542	3.5	0.14	107.950	4.2500	27.000	1.0630	0.8	0.03	27.795	1.0943
461	453	42.850	1.6870	29.317	1.1542	0.8	0.03	107.950	4.2500	27.000	1.0630	0.8	0.03	27.795	1.0943
462	453	57.150	2.2500	29.317	1.1542	2.3	0.09	107.950	4.2500	27.000	1.0630	0.8	0.03	27.795	1.0943
467	453	47.625	1.8750	29.317	1.1542	0.8	0.03	107.950	4.2500	27.000	1.0630	0.8	0.03	27.795	1.0943
469	453	57.150	2.2500	29.317	1.1542	3.5	0.14	107.950	4.2500	27.000	1.0630	0.8	0.03	27.795	1.0943
455	453A	50.800	2.0000	29.317	1.1542	0.8	0.03	107.950	4.2500	22.225	0.8750	0.8	0.03	27.782	1.0938
460	453A	44.450	1.7500	29.317	1.1542	3.5	0.14	107.950	4.2500	22.225	0.8750	0.8	0.03	27.782	1.0938
461	453A	42.850	1.6870	29.317	1.1542	0.8	0.03	107.950	4.2500	22.225	0.8750	0.8	0.03	27.782	1.0938
462	453A	57.150	2.2500	29.317	1.1542	2.3	0.09	107.950	4.2500	22.225	0.8750	0.8	0.03	27.782	1.0938
467	453A	47.625	1.8750	29.317	1.1542	0.8	0.03	107.950	4.2500	22.225	0.8750	0.8	0.03	27.782	1.0938
469	453A	57.150	2.2500	29.317	1.1542	3.5	0.14	107.950	4.2500	22.225	0.8750	0.8	0.03	27.782	1.0938
455	453X	50.800	2.0000	29.317	1.1542	0.8	0.03	104.775	4.1250	24.605	0.9687	3.3	0.13	30.162	1.1875
460	453X	44.450	1.7500	29.317	1.1542	3.5	0.14	104.775	4.1250	24.605	0.9687	3.3	0.13	30.162	1.1875
461	453X	42.850	1.6870	29.317	1.1542	0.8	0.03	104.775	4.1250	24.605	0.9687	3.3	0.13	30.162	1.1875
462	453X	57.150	2.2500	29.317	1.1542	2.3	0.09	104.775	4.1250	24.605	0.9687	3.3	0.13	30.162	1.1875
467	453X	47.625	1.8750	29.317	1.1542	0.8	0.03	104.775	4.1250	24.605	0.9687	3.3	0.13	30.162	1.1875
469	453X	57.150	2.2500	29.317	1.1542	3.5	0.14	104.775	4.1250	24.605	0.9687	3.3	0.13	30.162	1.1875
455	454	50.800	2.0000	29.317	1.1542	0.8	0.03	110.000	4.3307	27.000	1.0630	2.0	0.08	27.795	1.0943
460	454	44.450	1.7500	29.317	1.1542	3.5	0.14	110.000	4.3307	27.000	1.0630	2.0	0.08	27.795	1.0943

$$P = X \cdot Fr + Y \cdot Fa$$

$\frac{Fa}{Fr} \leq e$		$\frac{Fa}{Fr} > e$	
X	Y	X	Y
1	0	0.40	See table

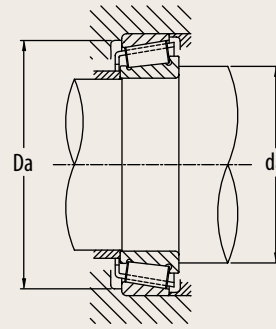

Cone	Cup	Basic Load Rating		a		e	Y Axial Load Factor	Da		da		Reference Speed RPM	Cone Weight Kg	Cup Weight Kg
		Dynamic Cr	Static Cor	Effective Load Center				Housing Bore ID		Shaft OD				
		KN	KN	mm	inch			mm	inch	mm	inch			
395 SERIES														
395	3920	82.5	108	0.5	0.02	0.40	1.49	98	3.86	78	3.07	3500	0.581	0.446
395A	3920	82.5	108	0.5	0.02	0.40	1.49	98	3.86	77	3.03	3500	0.531	0.446
396	3920	82.5	108	0.5	0.02	0.40	1.49	98	3.86	69	2.72	3500	0.793	0.446
396-S	3920	82.5	108	0.5	0.02	0.40	1.49	98	3.86	79	3.11	3500	0.555	0.446
399A	3920	82.5	108	0.5	0.02	0.40	1.49	98	3.86	79	3.11	3500	0.500	0.446
399AS	3920	82.5	108	0.5	0.02	0.40	1.49	98	3.86	82	3.23	3500	0.488	0.446
415 SERIES														
418	414	94.3	106	10.1	0.40	0.26	2.28	78	3.07	51	2.01	6000	0.507	0.327
420	414	94.3	106	10.1	0.40	0.26	2.28	78	3.07	52	2.05	6000	0.480	0.327
435 SERIES														
438	432A	104	123	9.4	0.37	0.28	2.11	84	3.31	58	2.28	5500	0.563	0.384
443	432A	104	123	9.4	0.37	0.28	2.11	84	3.31	48	1.89	5500	0.748	0.384
455 SERIES														
455	453	113	145	7.0	0.28	0.34	1.79	97	3.82	65	2.56	4500	0.814	0.480
460	453	113	145	7.0	0.28	0.34	1.79	97	3.82	64	2.52	4400	0.918	0.480
461	453	113	145	7.0	0.28	0.34	1.79	97	3.82	61	2.40	4400	0.947	0.480
462	453	113	145	7.0	0.28	0.34	1.79	97	3.82	70	2.76	4600	0.688	0.480
467	453	113	145	7.0	0.28	0.34	1.79	97	3.82	63	2.48	4500	0.870	0.480
469	453	113	145	7.0	0.28	0.34	1.79	97	3.82	71	2.80	4700	0.685	0.480
455	453A	113	145	7.0	0.28	0.34	1.79	97	3.82	65	2.56	4500	0.814	0.422
460	453A	113	145	7.0	0.28	0.34	1.79	97	3.82	64	2.52	4400	0.918	0.422
461	453A	113	145	7.0	0.28	0.34	1.79	97	3.82	61	2.40	4400	0.947	0.422
462	453A	113	145	7.0	0.28	0.34	1.79	97	3.82	70	2.76	4600	0.688	0.422
467	453A	113	145	7.0	0.28	0.34	1.79	97	3.82	63	2.48	4500	0.870	0.422
469	453A	113	145	7.0	0.28	0.34	1.79	97	3.82	71	2.80	4700	0.685	0.422
455	453X	113	145	7.0	0.28	0.34	1.79	92	3.62	65	2.56	4500	0.814	0.370
460	453X	113	145	7.0	0.28	0.34	1.79	92	3.62	64	2.52	4400	0.918	0.370
461	453X	113	145	7.0	0.28	0.34	1.79	92	3.62	61	2.40	4400	0.947	0.370
462	453X	113	145	7.0	0.28	0.34	1.79	92	3.62	70	2.76	4600	0.688	0.370
467	453X	113	145	7.0	0.28	0.34	1.79	92	3.62	63	2.48	4500	0.870	0.370
469	453X	113	145	7.0	0.28	0.34	1.79	92	3.62	71	2.80	4700	0.685	0.370
455	454	113	145	7.0	0.28	0.34	1.79	97	3.82	65	2.56	4500	0.814	0.550
460	454	113	145	7.0	0.28	0.34	1.79	97	3.82	64	2.52	4400	0.918	0.550

INCH SERIES

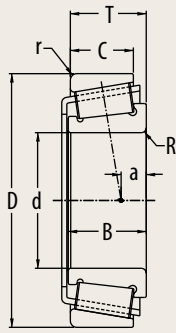

The tables include the most common industry series and sizes in the market. Additional industry series and sizes are available from PEER upon request.

Cone	Cup	d		B		R		D		C		r		T	
		Cone Bore		Cone Width		Max Shaft Radius		Cup Outer Diameter		Cup Width		Max Housing Radius		Total Width	
		mm	inch	mm	inch	mm	inch	mm	inch	mm	inch	mm	inch	mm	inch
455 SERIES (cont.)															
461	454	42.850	1.6870	29.317	1.1542	0.8	0.03	110.000	4.3307	27.000	1.0630	2.0	0.08	27.795	1.0943
462	454	57.150	2.2500	29.317	1.1542	2.3	0.09	110.000	4.3307	27.000	1.0630	2.0	0.08	27.795	1.0943
467	454	47.625	1.8750	29.317	1.1542	0.8	0.03	110.000	4.3307	27.000	1.0630	2.0	0.08	27.795	1.0943
469	454	57.150	2.2500	29.317	1.1542	3.5	0.14	110.000	4.3307	27.000	1.0630	2.0	0.08	27.795	1.0943
475 SERIES															
480	472	68.262	2.6875	29.007	1.1420	3.5	0.14	120.000	4.7244	24.237	0.9542	2.0	0.08	29.794	1.1730
482	472	69.850	2.7500	29.007	1.1420	3.5	0.14	120.000	4.7244	24.237	0.9542	2.0	0.08	29.794	1.1730
483	472	63.500	2.5000	29.007	1.1420	3.5	0.14	120.000	4.7244	24.237	0.9542	2.0	0.08	29.794	1.1730
484	472	70.000	2.7559	29.007	1.1420	2.0	0.08	120.000	4.7244	24.237	0.9542	2.0	0.08	29.794	1.1730
480	472A	68.262	2.6875	29.007	1.1420	3.5	0.14	120.000	4.7244	23.444	0.9230	3.3	0.13	29.002	1.1418
482	472A	69.850	2.7500	29.007	1.1420	3.5	0.14	120.000	4.7244	23.444	0.9230	3.3	0.13	29.002	1.1418
483	472A	63.500	2.5000	29.007	1.1420	3.5	0.14	120.000	4.7244	23.444	0.9230	3.3	0.13	29.002	1.1418
484	472A	70.000	2.7559	29.007	1.1420	2.0	0.08	120.000	4.7244	23.444	0.9230	3.3	0.13	29.002	1.1418
480	472X	68.262	2.6875	29.007	1.1420	3.5	0.14	123.825	4.8750	24.605	0.9687	3.3	0.13	30.162	1.1875
482	472X	69.850	2.7500	29.007	1.1420	3.5	0.14	123.825	4.8750	24.605	0.9687	3.3	0.13	30.162	1.1875
483	472X	63.500	2.5000	29.007	1.1420	3.5	0.14	123.825	4.8750	24.605	0.9687	3.3	0.13	30.162	1.1875
484	472X	70.000	2.7559	29.007	1.1420	2.0	0.08	123.825	4.8750	24.605	0.9687	3.3	0.13	30.162	1.1875
495 SERIES															
495	492A	82.550	3.2500	29.769	1.1720	3.5	0.14	133.350	5.2500	22.225	0.8750	3.3	0.13	30.162	1.1875
495A	492A	76.200	3.0000	29.769	1.1720	3.5	0.14	133.350	5.2500	22.225	0.8750	3.3	0.13	30.162	1.1875
495AX	492A	76.200	3.0000	29.769	1.1720	6.4	0.25	133.350	5.2500	22.225	0.8750	3.3	0.13	30.162	1.1875
496	492A	80.962	3.1875	29.769	1.1720	3.5	0.14	133.350	5.2500	22.225	0.8750	3.3	0.13	30.162	1.1875
497	492A	85.725	3.3750	29.769	1.1720	3.5	0.14	133.350	5.2500	22.225	0.8750	3.3	0.13	30.162	1.1875
498	492A	84.138	3.3125	29.769	1.1720	3.5	0.14	133.350	5.2500	22.225	0.8750	3.3	0.13	30.162	1.1875
495	493	82.550	3.2500	29.769	1.1720	3.5	0.14	136.525	5.3750	22.225	0.8750	3.3	0.13	30.162	1.1875
495A	493	76.200	3.0000	29.769	1.1720	3.5	0.14	136.525	5.3750	22.225	0.8750	3.3	0.13	30.162	1.1875
495AX	493	76.200	3.0000	29.769	1.1720	6.4	0.25	136.525	5.3750	22.225	0.8750	3.3	0.13	30.162	1.1875
496	493	80.962	3.1875	29.769	1.1720	3.5	0.14	136.525	5.3750	22.225	0.8750	3.3	0.13	30.162	1.1875
497	493	85.725	3.3750	29.769	1.1720	3.5	0.14	136.525	5.3750	22.225	0.8750	3.3	0.13	30.162	1.1875
498	493	84.138	3.3125	29.769	1.1720	3.5	0.14	136.525	5.3750	22.225	0.8750	3.3	0.13	30.162	1.1875
525 SERIES															
526	522	41.275	1.6250	36.068	1.4200	3.5	0.14	101.600	4.0000	26.988	1.0625	3.3	0.13	34.925	1.3750
527	522	44.450	1.7500	36.068	1.4200	3.5	0.14	101.600	4.0000	26.988	1.0625	3.3	0.13	34.925	1.3750

$P = X \cdot Fr + Y \cdot Fa$			
$\frac{Fa}{Fr} \leq e$		$\frac{Fa}{Fr} > e$	
X	Y	X	Y
1	0	0.40	See table

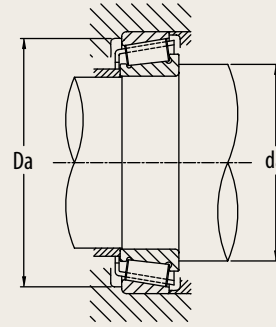

Cone	Cup	Basic Load Rating		a		e	Y Axial Load Factor	Da		da		Reference Speed RPM	Cone Weight Kg	Cup Weight Kg
		Dynamic Cr	Static Cor	Effective Load Center				Housing Bore ID		Shaft OD				
		KN	KN	mm	inch			mm	inch	mm	inch			
455 SERIES														
461	454	113	145	7.0	0.28	0.34	1.79	97	3.82	61	2.40	4400	0.947	0.550
462	454	113	145	7.0	0.28	0.34	1.79	97	3.82	70	2.76	4600	0.688	0.550
467	454	113	145	7.0	0.28	0.34	1.79	97	3.82	63	2.48	4500	0.870	0.550
469	454	113	145	7.0	0.28	0.34	1.79	97	3.82	71	2.80	4700	0.685	0.550
475 SERIES														
480	472	118	161	4.0	0.16	0.38	1.56	107	4.21	83	3.27	4000	0.846	0.489
482	472	118	161	4.0	0.16	0.38	1.56	107	4.21	84	3.31	4000	0.807	0.489
483	472	118	161	4.0	0.16	0.38	1.56	107	4.21	81	3.19	4000	0.958	0.489
484	472	118	161	4.0	0.16	0.38	1.56	107	4.21	83	3.27	4000	0.808	0.489
480	472A	118	161	4.0	0.16	0.38	1.56	106	4.17	83	3.27	4000	0.846	0.459
482	472A	118	161	4.0	0.16	0.38	1.56	106	4.17	84	3.31	4000	0.807	0.459
483	472A	118	161	4.0	0.16	0.38	1.56	106	4.17	81	3.19	4000	0.958	0.459
484	472A	118	161	4.0	0.16	0.38	1.56	106	4.17	83	3.27	4000	0.808	0.459
480	472X	118	161	4.0	0.16	0.38	1.56	108	4.25	83	3.27	4000	0.846	0.632
482	472X	118	161	4.0	0.16	0.38	1.56	108	4.25	84	3.31	4000	0.807	0.632
483	472X	118	161	4.0	0.16	0.38	1.56	108	4.25	81	3.19	4000	0.958	0.632
484	472X	118	161	4.0	0.16	0.38	1.56	108	4.25	83	3.27	4000	0.808	0.632
495 SERIES														
495	492A	128	188	0.6	0.02	0.44	1.35	120	4.72	99	3.90	3500	1.060	0.425
495A	492A	128	188	0.6	0.02	0.44	1.35	120	4.72	95	3.74	3400	1.250	0.425
495AX	492A	128	188	0.6	0.02	0.44	1.35	120	4.72	98	3.86	3400	1.230	0.425
496	492A	128	188	0.6	0.02	0.44	1.35	120	4.72	98	3.86	3500	1.110	0.425
497	492A	128	188	0.6	0.02	0.44	1.35	120	4.72	100	3.94	3500	0.966	0.425
498	492A	128	188	0.6	0.02	0.44	1.35	120	4.72	100	3.94	3500	1.020	0.425
495	493	128	188	0.6	0.02	0.44	1.35	122	4.80	99	3.90	3500	1.060	0.541
495A	493	128	188	0.6	0.02	0.44	1.35	122	4.80	95	3.74	3400	1.250	0.541
495AX	493	128	188	0.6	0.02	0.44	1.35	122	4.80	98	3.86	3400	1.230	0.541
496	493	128	188	0.6	0.02	0.44	1.35	122	4.80	98	3.86	3500	1.110	0.541
497	493	128	188	0.6	0.02	0.44	1.35	122	4.80	100	3.94	3500	0.966	0.541
498	493	128	188	0.6	0.02	0.44	1.35	122	4.80	99	3.90	3500	1.020	0.541
525 SERIES														
526	522	135	164	12.6	0.50	0.29	2.10	89	3.50	60	2.36	5000	1.030	0.409
527	522	135	164	12.6	0.50	0.29	2.10	89	3.50	62	2.44	5000	0.973	0.409

INCH SERIES

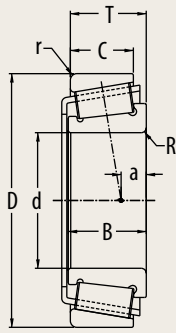

The tables include the most common industry series and sizes in the market. Additional industry series and sizes are available from PEER upon request.

Cone	Cup	d		B		R		D		C		r		T	
		Cone Bore		Cone Width		Max Shaft Radius		Cup Outer Diameter		Cup Width		Max Housing Radius		Total Width	
		mm	inch	mm	inch	mm	inch	mm	inch	mm	inch	mm	inch	mm	inch
525 SERIES (cont.)															
528	522	47.625	1.8750	36.068	1.4200	3.5	0.14	101.600	4.0000	26.988	1.0625	3.3	0.13	34.925	1.3750
529	522	50.800	2.0000	36.068	1.4200	0.8	0.03	101.600	4.0000	26.988	1.0625	3.3	0.13	34.925	1.3750
529X	522	50.800	2.0000	36.068	1.4200	3.5	0.14	101.600	4.0000	26.988	1.0625	3.3	0.13	34.925	1.3750
535 SERIES															
535	532A	44.450	1.7500	36.957	1.4550	3.5	0.14	111.125	4.3750	30.162	1.1875	3.3	0.13	38.100	1.5000
536	532A	47.625	1.8750	36.957	1.4550	3.5	0.14	111.125	4.3750	30.162	1.1875	3.3	0.13	38.100	1.5000
537	532A	50.800	2.0000	36.957	1.4550	3.5	0.14	111.125	4.3750	30.162	1.1875	3.3	0.13	38.100	1.5000
539	532A	53.975	2.1250	36.957	1.4550	3.5	0.14	111.125	4.3750	30.162	1.1875	3.3	0.13	38.100	1.5000
539A	532A	53.975	2.1250	36.957	1.4550	5.5	0.22	111.125	4.3750	30.162	1.1875	3.3	0.13	38.100	1.5000
543	532A	40.000	1.5748	36.957	1.4550	3.5	0.14	111.125	4.3750	30.162	1.1875	3.3	0.13	38.100	1.5000
535	532X	44.450	1.7500	36.957	1.4550	3.5	0.14	107.950	4.2500	28.575	1.1250	3.3	0.13	36.513	1.4375
536	532X	47.625	1.8750	36.957	1.4550	3.5	0.14	107.950	4.2500	28.575	1.1250	3.3	0.13	36.513	1.4375
537	532X	50.800	2.0000	36.957	1.4550	3.5	0.14	107.950	4.2500	28.575	1.1250	3.3	0.13	36.513	1.4375
539	532X	53.975	2.1250	36.957	1.4550	3.5	0.14	107.950	4.2500	28.575	1.1250	3.3	0.13	36.513	1.4375
539A	532X	53.975	2.1250	36.957	1.4550	5.5	0.22	107.950	4.2500	28.575	1.1250	3.3	0.13	36.513	1.4375
543	532X	40.000	1.5748	36.957	1.4550	3.5	0.14	107.950	4.2500	28.575	1.1250	3.3	0.13	36.513	1.4375
555 SERIES															
555	552	50.800	2.0000	36.678	1.4440	2.3	0.09	123.825	4.8750	33.338	1.3125	3.3	0.13	38.100	1.5000
555-S	552	57.150	2.2500	36.678	1.4440	3.5	0.14	123.825	4.8750	33.338	1.3125	3.3	0.13	38.100	1.5000
557-S	552	53.975	2.1250	36.678	1.4440	3.5	0.14	123.825	4.8750	33.338	1.3125	3.3	0.13	38.100	1.5000
557A	552	60.325	2.3750	36.678	1.4440	8.0	0.31	123.825	4.8750	33.338	1.3125	3.3	0.13	38.100	1.5000
559	552	63.500	2.5000	36.678	1.4440	3.5	0.14	123.825	4.8750	33.338	1.3125	3.3	0.13	38.100	1.5000
560	552	66.675	2.6250	36.678	1.4440	3.5	0.14	123.825	4.8750	33.338	1.3125	3.3	0.13	38.100	1.5000
555	552A	50.800	2.0000	36.678	1.4440	2.3	0.09	123.825	4.8750	30.162	1.1875	3.3	0.13	38.100	1.5000
555-S	552A	57.150	2.2500	36.678	1.4440	3.5	0.14	123.825	4.8750	30.162	1.1875	3.3	0.13	38.100	1.5000
557-S	552A	53.975	2.1250	36.678	1.4440	3.5	0.14	123.825	4.8750	30.162	1.1875	3.3	0.13	38.100	1.5000
557A	552A	60.325	2.3750	36.678	1.4440	8.0	0.31	123.825	4.8750	30.162	1.1875	3.3	0.13	38.100	1.5000
559	552A	63.500	2.5000	36.678	1.4440	3.5	0.14	123.825	4.8750	30.162	1.1875	3.3	0.13	38.100	1.5000
560	552A	66.675	2.6250	36.678	1.4440	3.5	0.14	123.825	4.8750	30.162	1.1875	3.3	0.13	38.100	1.5000
565 SERIES															
567	563	73.025	2.8750	36.170	1.4240	3.5	0.14	127.000	5.0000	28.575	1.1250	3.3	0.13	36.512	1.4375
575 SERIES															
575	572	76.200	3.0000	36.098	1.4212	3.5	0.14	139.992	5.5115	28.575	1.1250	3.3	0.13	36.512	1.4375

$$P = X \cdot Fr + Y \cdot Fa$$

$\frac{Fa}{Fr} \leq e$		$\frac{Fa}{Fr} > e$	
X	Y	X	Y
1	0	0.40	See table

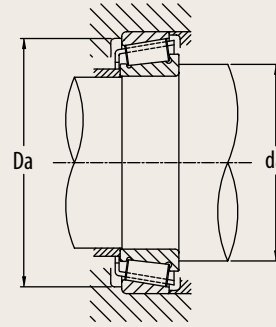

Cone	Cup	Basic Load Rating		a		e	Y Axial Load Factor	Da		da		Reference Speed RPM	Cone Weight Kg	Cup Weight Kg
		Dynamic Cr	Static Cor	Effective Load Center				Housing Bore ID		Shaft OD				
		KN	KN	mm	inch			mm	inch	mm	inch			
525 SERIES														
528	522	135	164	12.6	0.50	0.29	2.10	89	3.50	64	2.52	5000	0.908	0.409
529	522	135	164	12.6	0.50	0.29	2.10	89	3.50	61	2.40	5000	0.843	0.409
529X	522	135	164	12.6	0.50	0.29	2.10	89	3.50	64	2.52	5000	0.831	0.409
535 SERIES														
535	532A	140	176	12.2	0.48	0.30	2.02	93	3.66	60	2.36	5400	1.090	0.740
536	532A	140	176	12.2	0.48	0.30	2.02	93	3.66	62	2.44	5400	1.020	0.740
537	532A	140	176	12.2	0.48	0.30	2.02	93	3.66	64	2.52	5400	0.949	0.740
539	532A	140	176	12.2	0.48	0.30	2.02	93	3.66	68	2.68	5400	0.873	0.740
539A	532A	140	176	12.2	0.48	0.30	2.02	93	3.66	70	2.76	5400	0.865	0.740
543	532A	140	176	12.2	0.48	0.30	2.02	93	3.66	58	2.28	5400	1.170	0.740
535	532X	140	176	12.2	0.48	0.30	2.02	93	3.66	60	2.36	5400	1.090	0.569
536	532X	140	176	12.2	0.48	0.30	2.02	93	3.66	62	2.44	5400	1.020	0.569
537	532X	140	176	12.2	0.48	0.30	2.02	93	3.66	64	2.52	5400	0.949	0.569
539	532X	140	176	12.2	0.48	0.30	2.02	93	3.66	68	2.68	5400	0.873	0.569
539A	532X	140	176	12.2	0.48	0.30	2.02	93	3.66	70	2.76	5400	0.865	0.569
543	532X	140	176	12.2	0.48	0.30	2.02	93	3.66	58	2.28	5400	1.170	0.569
555 SERIES														
555	552	157	215	9.3	0.37	0.35	1.73	108	4.25	72	2.83	4400	1.570	0.804
555-S	552	157	215	9.3	0.37	0.35	1.73	108	4.25	77	3.03	4400	1.410	0.804
557-S	552	157	215	9.3	0.37	0.35	1.73	108	4.25	75	2.95	4400	1.490	0.804
557A	552	157	215	9.3	0.37	0.35	1.73	108	4.25	83	3.27	4400	1.300	0.804
559	552	157	215	9.3	0.37	0.35	1.73	108	4.25	80	3.15	4400	1.240	0.804
560	552	157	215	9.3	0.37	0.35	1.73	108	4.25	82	3.23	4400	1.150	0.804
555	552A	157	215	9.3	0.37	0.35	1.73	108	4.25	72	2.83	4400	1.570	0.755
555-S	552A	157	215	9.3	0.37	0.35	1.73	108	4.25	77	3.03	4400	1.410	0.755
557-S	552A	157	215	9.3	0.37	0.35	1.73	108	4.25	75	2.95	4400	1.490	0.755
557A	552A	157	215	9.3	0.37	0.35	1.73	108	4.25	83	3.27	4400	1.300	0.755
559	552A	157	215	9.3	0.37	0.35	1.73	108	4.25	80	3.15	4400	1.240	0.755
560	552A	157	215	9.3	0.37	0.35	1.73	108	4.25	82	3.23	4400	1.150	0.755
565 SERIES														
567	563	153	218	7.9	0.31	0.36	1.65	112	4.41	89	3.50	4000	1.150	0.646
575 SERIES														
575	572	170	251	5.5	0.22	0.40	1.49	124	4.88	96	3.78	3600	1.570	0.778

INCH SERIES

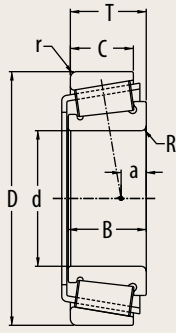

The tables include the most common industry series and sizes in the market. Additional industry series and sizes are available from PEER upon request.

Cone	Cup	d		B		R		D		C		r		T	
		Cone Bore		Cone Width		Max Shaft Radius		Cup Outer Diameter		Cup Width		Max Housing Radius		Total Width	
		mm	inch	mm	inch	mm	inch	mm	inch	mm	inch	mm	inch	mm	inch
575 SERIES (cont.)															
575-S	572	76.200	3.0000	36.098	1.4212	6.8	0.27	139.992	5.5115	28.575	1.1250	3.3	0.13	36.512	1.4375
576	572	73.025	2.8750	36.098	1.4212	3.5	0.14	139.992	5.5115	28.575	1.1250	3.3	0.13	36.512	1.4375
577	572	74.612	2.9375	36.098	1.4212	3.5	0.14	139.992	5.5115	28.575	1.1250	3.3	0.13	36.512	1.4375
580	572	82.550	3.2500	36.098	1.4212	3.5	0.14	139.992	5.5115	28.575	1.1250	3.3	0.13	36.512	1.4375
581	572	80.962	3.1875	36.098	1.4212	3.5	0.14	139.992	5.5115	28.575	1.1250	3.3	0.13	36.512	1.4375
582	572	82.550	3.2500	36.098	1.4212	6.8	0.27	139.992	5.5115	28.575	1.1250	3.3	0.13	36.512	1.4375
575	572X	76.200	3.0000	36.098	1.4212	3.5	0.14	139.700	5.5000	28.575	1.1250	3.3	0.13	36.512	1.4375
575-S	572X	76.200	3.0000	36.098	1.4212	6.8	0.27	139.700	5.5000	28.575	1.1250	3.3	0.13	36.512	1.4375
576	572X	73.025	2.8750	36.098	1.4212	3.5	0.14	139.700	5.5000	28.575	1.1250	3.3	0.13	36.512	1.4375
577	572X	74.612	2.9375	36.098	1.4212	3.5	0.14	139.700	5.5000	28.575	1.1250	3.3	0.13	36.512	1.4375
580	572X	82.550	3.2500	36.098	1.4212	3.5	0.14	139.700	5.5000	28.575	1.1250	3.3	0.13	36.512	1.4375
581	572X	80.962	3.1875	36.098	1.4212	3.5	0.14	139.700	5.5000	28.575	1.1250	3.3	0.13	36.512	1.4375
582	572X	82.550	3.2500	36.098	1.4212	6.8	0.27	139.700	5.5000	28.575	1.1250	3.3	0.13	36.512	1.4375
595 SERIES															
593	592	88.900	3.5000	36.322	1.4300	3.5	0.14	152.400	6.0000	33.338	1.3125	3.3	0.13	39.688	1.5625
593A	592	88.900	3.5000	36.322	1.4300	6.4	0.25	152.400	6.0000	33.338	1.3125	3.3	0.13	39.688	1.5625
594	592	95.250	3.7500	36.322	1.4300	3.5	0.14	152.400	6.0000	33.338	1.3125	3.3	0.13	39.688	1.5625
594A	592	95.250	3.7500	36.322	1.4300	5.0	0.20	152.400	6.0000	33.338	1.3125	3.3	0.13	39.688	1.5625
595	592	82.550	3.2500	36.322	1.4300	3.5	0.14	152.400	6.0000	33.338	1.3125	3.3	0.13	39.688	1.5625
596	592	85.725	3.3750	36.322	1.4300	3.5	0.14	152.400	6.0000	33.338	1.3125	3.3	0.13	39.688	1.5625
598	592	92.075	3.6250	36.322	1.4300	3.5	0.14	152.400	6.0000	33.338	1.3125	3.3	0.13	39.688	1.5625
598A	592	92.075	3.6250	36.322	1.4300	6.4	0.25	152.400	6.0000	33.338	1.3125	3.3	0.13	39.688	1.5625
593	592A	88.900	3.5000	36.322	1.4300	3.5	0.14	152.400	6.0000	30.162	1.1875	3.3	0.13	39.688	1.5625
593A	592A	88.900	3.5000	36.322	1.4300	6.4	0.25	152.400	6.0000	30.162	1.1875	3.3	0.13	39.688	1.5625
594	592A	95.250	3.7500	36.322	1.4300	3.5	0.14	152.400	6.0000	30.162	1.1875	3.3	0.13	39.688	1.5625
594A	592A	95.250	3.7500	36.322	1.4300	5.0	0.20	152.400	6.0000	30.162	1.1875	3.3	0.13	39.688	1.5625
595	592A	82.550	3.2500	36.322	1.4300	3.5	0.14	152.400	6.0000	30.162	1.1875	3.3	0.13	39.688	1.5625
596	592A	85.725	3.3750	36.322	1.4300	3.5	0.14	152.400	6.0000	30.162	1.1875	3.3	0.13	39.688	1.5625
598	592A	92.075	3.6250	36.322	1.4300	3.5	0.14	152.400	6.0000	30.162	1.1875	3.3	0.13	39.688	1.5625
598A	592A	92.075	3.6250	36.322	1.4300	6.4	0.25	152.400	6.0000	30.162	1.1875	3.3	0.13	39.688	1.5625
593	592XS	88.900	3.5000	36.322	1.4300	3.5	0.14	147.638	5.8125	26.192	1.0312	3.3	0.13	35.718	1.4062
593A	592XS	88.900	3.5000	36.322	1.4300	6.4	0.25	147.638	5.8125	26.192	1.0312	3.3	0.13	35.718	1.4062
594	592XS	95.250	3.7500	36.322	1.4300	3.5	0.14	147.638	5.8125	26.192	1.0312	3.3	0.13	35.718	1.4062

$$P = X \cdot Fr + Y \cdot Fa$$

$\frac{Fa}{Fr} \leq e$		$\frac{Fa}{Fr} > e$	
X	Y	X	Y
1	0	0.40	See table

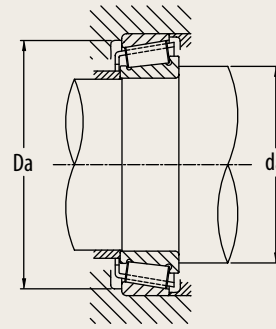

Cone	Cup	Basic Load Rating		a		e	Y Axial Load Factor	Da		da		Reference Speed RPM	Cone Weight Kg	Cup Weight Kg
		Dynamic Cr	Static Cor	Effective Load Center				Housing Bore ID		Shaft OD				
		KN	KN	mm	inch			mm	inch	mm	inch			
575 SERIES														
575-S	572	170	251	5.5	0.22	0.40	1.49	124	4.88	99	3.90	3600	1.550	0.778
576	572	170	251	5.5	0.22	0.40	1.49	124	4.88	94	3.70	3600	1.680	0.778
577	572	170	251	5.5	0.22	0.40	1.49	124	4.88	95	3.74	3600	1.630	0.778
580	572	170	251	5.5	0.22	0.40	1.49	124	4.88	99	3.90	3600	1.350	0.778
581	572	170	251	5.5	0.22	0.40	1.49	124	4.88	98	3.86	3600	1.410	0.778
582	572	170	251	5.5	0.22	0.40	1.49	124	4.88	102	4.02	3600	1.330	0.778
575	572X	170	251	5.5	0.22	0.40	1.49	124	4.88	96	3.78	3600	1.570	0.763
575-S	572X	170	251	5.5	0.22	0.40	1.49	124	4.88	99	3.90	3600	1.550	0.763
576	572X	170	251	5.5	0.22	0.40	1.49	124	4.88	94	3.70	3600	1.680	0.763
577	572X	170	251	5.5	0.22	0.40	1.49	124	4.88	95	3.74	3600	1.630	0.763
580	572X	170	251	5.5	0.22	0.40	1.49	124	4.88	99	3.90	3600	1.350	0.763
581	572X	170	251	5.5	0.22	0.40	1.49	124	4.88	98	3.86	3600	1.410	0.763
582	572X	170	251	5.5	0.22	0.40	1.49	124	4.88	102	4.02	3600	1.330	0.763
595 SERIES														
593	592	179	277	2.6	0.10	0.44	1.36	134	5.28	108	4.25	3000	1.680	1.100
593A	592	179	277	2.6	0.10	0.44	1.36	134	5.28	111	4.37	3000	1.660	1.100
594	592	179	277	2.6	0.10	0.44	1.36	134	5.28	111	4.37	3000	1.420	1.100
594A	592	179	277	2.6	0.10	0.44	1.36	134	5.28	113	4.45	3000	1.410	1.100
595	592	179	277	2.6	0.10	0.44	1.36	134	5.28	105	4.13	3000	1.930	1.100
596	592	179	277	2.6	0.10	0.44	1.36	134	5.28	106	4.17	3000	1.810	1.100
598	592	179	277	2.6	0.10	0.44	1.36	134	5.28	110	4.33	3000	1.550	1.100
598A	592	179	277	2.6	0.10	0.44	1.36	134	5.28	112	4.41	3000	1.530	1.100
593	592A	179	277	2.6	0.10	0.44	1.36	134	5.28	108	4.25	3000	1.680	1.050
593A	592A	179	277	2.6	0.10	0.44	1.36	134	5.28	111	4.37	3000	1.660	1.050
594	592A	179	277	2.6	0.10	0.44	1.36	134	5.28	111	4.37	3000	1.420	1.050
594A	592A	179	277	2.6	0.10	0.44	1.36	134	5.28	113	4.45	3000	1.410	1.050
595	592A	179	277	2.6	0.10	0.44	1.36	134	5.28	105	4.13	3000	1.930	1.050
596	592A	179	277	2.6	0.10	0.44	1.36	134	5.28	106	4.17	3000	1.810	1.050
598	592A	179	277	2.6	0.10	0.44	1.36	134	5.28	110	4.33	3000	1.550	1.050
598A	592A	179	277	2.6	0.10	0.44	1.36	134	5.28	112	4.41	3000	1.530	1.050
593	592XS	179	277	2.6	0.10	0.44	1.36	133	5.24	108	4.25	3000	1.680	0.628
593A	592XS	179	277	2.6	0.10	0.44	1.36	133	5.24	111	4.37	3000	1.660	0.628
594	592XS	179	277	2.6	0.10	0.44	1.36	133	5.24	111	4.37	3000	1.420	0.628

INCH SERIES

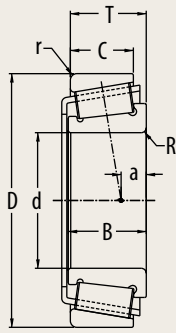

The tables include the most common industry series and sizes in the market. Additional industry series and sizes are available from PEER upon request.

Cone	Cup	d		B		R		D		C		r		T	
		Cone Bore		Cone Width		Max Shaft Radius		Cup Outer Diameter		Cup Width		Max Housing Radius		Total Width	
		mm	inch	mm	inch	mm	inch	mm	inch	mm	inch	mm	inch	mm	inch
595 SERIES (cont.)															
594A	592XS	95.250	3.7500	36.322	1.4300	5.0	0.20	147.638	5.8125	26.192	1.0312	3.3	0.13	35.718	1.4062
595	592XS	82.550	3.2500	36.322	1.4300	3.5	0.14	147.638	5.8125	26.192	1.0312	3.3	0.13	35.718	1.4062
596	592XS	85.725	3.3750	36.322	1.4300	3.5	0.14	147.638	5.8125	26.192	1.0312	3.3	0.13	35.718	1.4062
598	592XS	92.075	3.6250	36.322	1.4300	3.5	0.14	147.638	5.8125	26.192	1.0312	3.3	0.13	35.718	1.4062
598A	592XS	92.075	3.6250	36.322	1.4300	6.4	0.25	147.638	5.8125	26.192	1.0312	3.3	0.13	35.718	1.4062
593	593X	88.900	3.5000	36.322	1.4300	3.5	0.14	150.000	5.9055	27.000	1.0630	3.0	0.12	35.992	1.4170
593A	593X	88.900	3.5000	36.322	1.4300	6.4	0.25	150.000	5.9055	27.000	1.0630	3.0	0.12	35.992	1.4170
594	593X	95.250	3.7500	36.322	1.4300	3.5	0.14	150.000	5.9055	27.000	1.0630	3.0	0.12	35.992	1.4170
594A	593X	95.250	3.7500	36.322	1.4300	5.0	0.20	150.000	5.9055	27.000	1.0630	3.0	0.12	35.992	1.4170
595	593X	82.550	3.2500	36.322	1.4300	3.5	0.14	150.000	5.9055	27.000	1.0630	3.0	0.12	35.992	1.4170
596	593X	85.725	3.3750	36.322	1.4300	3.5	0.14	150.000	5.9055	27.000	1.0630	3.0	0.12	35.992	1.4170
598	593X	92.075	3.6250	36.322	1.4300	3.5	0.14	150.000	5.9055	27.000	1.0630	3.0	0.12	35.992	1.4170
598A	593X	92.075	3.6250	36.322	1.4300	6.4	0.25	150.000	5.9055	27.000	1.0630	3.0	0.12	35.992	1.4170
615 SERIES															
620	612	39.688	1.5625	41.275	1.6250	0.8	0.03	120.650	4.7500	31.750	1.2500	3.3	0.13	41.275	1.6250
621	612	53.975	2.1250	41.275	1.6250	3.5	0.14	120.650	4.7500	31.750	1.2500	3.3	0.13	41.275	1.6250
623	612	57.150	2.2500	41.275	1.6250	3.5	0.14	120.650	4.7500	31.750	1.2500	3.3	0.13	41.275	1.6250
635 SERIES															
635	632	57.150	2.2500	41.275	1.6250	3.5	0.14	136.525	5.3750	31.750	1.2500	3.3	0.13	41.275	1.6250
639	632	63.500	2.5000	41.275	1.6250	3.5	0.14	136.525	5.3750	31.750	1.2500	3.3	0.13	41.275	1.6250
641	632	66.675	2.6250	41.275	1.6250	3.5	0.14	136.525	5.3750	31.750	1.2500	3.3	0.13	41.275	1.6250
643	632	69.850	2.7500	41.275	1.6250	3.5	0.14	136.525	5.3750	31.750	1.2500	3.3	0.13	41.275	1.6250
645	632	71.438	2.8125	41.275	1.6250	6.4	0.25	136.525	5.3750	31.750	1.2500	3.3	0.13	41.275	1.6250
635	633	57.150	2.2500	41.275	1.6250	3.5	0.14	130.175	5.1250	31.750	1.2500	3.3	0.13	41.275	1.6250
639	633	63.500	2.5000	41.275	1.6250	3.5	0.14	130.175	5.1250	31.750	1.2500	3.3	0.13	41.275	1.6250
641	633	66.675	2.6250	41.275	1.6250	3.5	0.14	130.175	5.1250	31.750	1.2500	3.3	0.13	41.275	1.6250
643	633	69.850	2.7500	41.275	1.6250	3.5	0.14	130.175	5.1250	31.750	1.2500	3.3	0.13	41.275	1.6250
645	633	71.438	2.8125	41.275	1.6250	6.4	0.25	130.175	5.1250	31.750	1.2500	3.3	0.13	41.275	1.6250
655 SERIES															
659	652	76.200	3.0000	41.275	1.6250	3.5	0.14	152.400	6.0000	31.750	1.2500	3.3	0.13	41.275	1.6250
663	652	82.550	3.2500	41.275	1.6250	3.5	0.14	152.400	6.0000	31.750	1.2500	3.3	0.13	41.275	1.6250
665	652	85.725	3.3750	41.275	1.6250	3.5	0.14	152.400	6.0000	31.750	1.2500	3.3	0.13	41.275	1.6250
665A	652	85.725	3.3750	41.275	1.6250	6.4	0.25	152.400	6.0000	31.750	1.2500	3.3	0.13	41.275	1.6250

$$P = X \cdot Fr + Y \cdot Fa$$

$\frac{Fa}{Fr} \leq e$		$\frac{Fa}{Fr} > e$	
X	Y	X	Y
1	0	0.40	See table

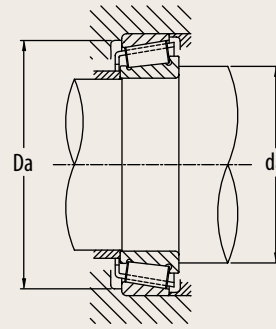

Cone	Cup	Basic Load Rating		a		e	Y Axial Load Factor	Da		da		Reference Speed RPM	Cone Weight Kg	Cup Weight Kg
		Dynamic Cr	Static Cor	Effective Load Center				Housing Bore ID		Shaft OD				
		KN	KN	mm	inch			mm	inch	mm	inch			
595 SERIES														
594A	592XS	179	277	2.6	0.10	0.44	1.36	133	5.24	113	4.45	3000	1.410	0.628
595	592XS	179	277	2.6	0.10	0.44	1.36	133	5.24	105	4.13	3000	1.930	0.628
596	592XS	179	277	2.6	0.10	0.44	1.36	133	5.24	106	4.17	3000	1.810	0.628
598	592XS	179	277	2.6	0.10	0.44	1.36	133	5.24	110	4.33	3000	1.550	0.628
598A	592XS	179	277	2.6	0.10	0.44	1.36	133	5.24	112	4.41	3000	1.530	0.628
593	593X	179	277	2.6	0.10	0.44	1.36	135	5.31	108	4.25	3000	1.680	0.763
593A	593X	179	277	2.6	0.10	0.44	1.36	135	5.31	111	4.37	3000	1.660	0.763
594	593X	179	277	2.6	0.10	0.44	1.36	135	5.31	111	4.37	3000	1.420	0.763
594A	593X	179	277	2.6	0.10	0.44	1.36	135	5.31	113	4.45	3000	1.410	0.763
595	593X	179	277	2.6	0.10	0.44	1.36	135	5.31	105	4.13	3000	1.930	0.763
596	593X	179	277	2.6	0.10	0.44	1.36	135	5.31	106	4.17	3000	1.810	0.763
598	593X	179	277	2.6	0.10	0.44	1.36	135	5.31	110	4.33	3000	1.550	0.763
598A	593X	179	277	2.6	0.10	0.44	1.36	135	5.31	112	4.41	3000	1.530	0.763
615 SERIES														
620	612	170	210	14.0	0.55	0.31	1.91	104	4.09	62	2.44	5000	1.680	0.853
621	612	170	210	14.0	0.55	0.31	1.91	104	4.09	71	2.80	5000	1.330	0.853
623	612	170	210	14.0	0.55	0.31	1.91	104	4.09	73	2.87	5000	1.240	0.853
635 SERIES														
635	632	192	258	11.0	0.43	0.36	1.66	118	4.65	81	3.19	4000	1.980	1.030
639	632	192	258	11.0	0.43	0.36	1.66	118	4.65	85	3.35	4000	1.780	1.030
641	632	192	258	11.0	0.43	0.36	1.66	118	4.65	86	3.39	4000	1.680	1.030
643	632	192	258	11.0	0.43	0.36	1.66	118	4.65	88	3.46	4000	1.570	1.030
645	632	192	258	11.0	0.43	0.36	1.66	118	4.65	89	3.50	4000	1.500	1.030
635	633	192	258	11.0	0.43	0.36	1.66	115	4.53	81	3.19	4000	1.980	0.702
639	633	192	258	11.0	0.43	0.36	1.66	115	4.53	85	3.35	4000	1.780	0.702
641	633	192	258	11.0	0.43	0.36	1.66	115	4.53	86	3.39	4000	1.680	0.702
643	633	192	258	11.0	0.43	0.36	1.66	115	4.53	88	3.46	4000	1.570	0.702
645	633	192	258	11.0	0.43	0.36	1.66	115	4.53	89	3.50	4000	1.500	0.702
655 SERIES														
659	652	203	288	7.7	0.30	0.41	1.47	133	5.24	98	3.86	3500	2.110	1.250
663	652	203	288	7.7	0.30	0.41	1.47	133	5.24	101	3.98	3500	1.870	1.250
665	652	203	288	7.7	0.30	0.41	1.47	133	5.24	103	4.06	3500	1.830	1.250
665A	652	203	288	7.7	0.30	0.41	1.47	133	5.24	106	4.17	3500	1.710	1.250

INCH SERIES

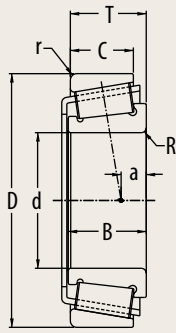

The tables include the most common industry series and sizes in the market. Additional industry series and sizes are available from PEER upon request.

Cone	Cup	d		B		R		D		C		r		T	
		Cone Bore		Cone Width		Max Shaft Radius		Cup Outer Diameter		Cup Width		Max Housing Radius		Total Width	
		mm	inch	mm	inch	mm	inch	mm	inch	mm	inch	mm	inch	mm	inch
655 SERIES (cont.)															
662	652	80.962	3.1875	38.100	1.5000	3.5	0.14	152.400	6.0000	31.750	1.2500	3.3	0.13	38.100	1.5000
659	653	76.200	3.0000	41.275	1.6250	3.5	0.14	146.050	5.7500	31.750	1.2500	3.3	0.13	41.275	1.6250
663	653	82.550	3.2500	41.275	1.6250	3.5	0.14	146.050	5.7500	31.750	1.2500	3.3	0.13	41.275	1.6250
665	653	85.725	3.3750	41.275	1.6250	3.5	0.14	146.050	5.7500	31.750	1.2500	3.3	0.13	41.275	1.6250
665A	653	85.725	3.3750	41.275	1.6250	6.4	0.25	146.050	5.7500	31.750	1.2500	3.3	0.13	41.275	1.6250
662	653	80.962	3.1875	38.100	1.5000	3.5	0.14	146.050	5.7500	31.750	1.2500	3.3	0.13	38.100	1.5000
675 SERIES															
681	672	92.075	3.6250	41.275	1.6250	3.5	0.14	168.275	6.6250	30.162	1.1875	3.3	0.13	41.275	1.6250
681A	672	92.075	3.6250	41.275	1.6250	6.4	0.25	168.275	6.6250	30.162	1.1875	3.3	0.13	41.275	1.6250
683	672	95.250	3.7500	41.275	1.6250	3.5	0.14	168.275	6.6250	30.162	1.1875	3.3	0.13	41.275	1.6250
683XA	672	95.250	3.7500	41.275	1.6250	5.0	0.20	168.275	6.6250	30.162	1.1875	3.3	0.13	41.275	1.6250
685	672	98.425	3.8750	41.275	1.6250	3.5	0.14	168.275	6.6250	30.162	1.1875	3.3	0.13	41.275	1.6250
687	672	101.600	4.0000	41.275	1.6250	3.5	0.14	168.275	6.6250	30.162	1.1875	3.3	0.13	41.275	1.6250
689	672	103.188	4.0625	41.275	1.6250	3.5	0.14	168.275	6.6250	30.162	1.1875	3.3	0.13	41.275	1.6250
745 SERIES															
740	742	80.962	3.1875	46.672	1.8375	5.0	0.20	150.089	5.9090	36.512	1.4375	3.3	0.13	44.450	1.7500
744	742	73.025	2.8750	46.672	1.8375	3.5	0.14	150.089	5.9090	36.512	1.4375	3.3	0.13	44.450	1.7500
745A	742	69.850	2.7500	46.672	1.8375	3.5	0.14	150.089	5.9090	36.512	1.4375	3.3	0.13	44.450	1.7500
748	742	80.000	3.1496	46.672	1.8375	3.0	0.12	150.089	5.9090	36.512	1.4375	3.3	0.13	44.450	1.7500
749	742	85.026	3.3475	46.672	1.8375	3.5	0.14	150.089	5.9090	36.512	1.4375	3.3	0.13	44.450	1.7500
749-S	742	85.026	3.3475	46.672	1.8375	5.0	0.20	150.089	5.9090	36.512	1.4375	3.3	0.13	44.450	1.7500
749A	742	82.550	3.2500	46.672	1.8375	3.5	0.14	150.089	5.9090	36.512	1.4375	3.3	0.13	44.450	1.7500
750A	742	82.550	3.2500	46.672	1.8375	6.5	0.26	150.089	5.9090	36.512	1.4375	3.3	0.13	44.450	1.7500
755 SERIES															
756A	752	79.375	3.1250	48.260	1.9000	8.0	0.31	161.925	6.3750	38.100	1.5000	3.3	0.13	47.625	1.8750
758	752	85.725	3.3750	48.260	1.9000	3.5	0.14	161.925	6.3750	38.100	1.5000	3.3	0.13	47.625	1.8750
759	752	88.900	3.5000	48.260	1.9000	3.5	0.14	161.925	6.3750	38.100	1.5000	3.3	0.13	47.625	1.8750
760	752	90.488	3.5625	48.260	1.9000	3.5	0.14	161.925	6.3750	38.100	1.5000	3.3	0.13	47.625	1.8750
775 SERIES															
780	772	101.600	4.0000	48.006	1.8900	3.5	0.14	180.975	7.1250	38.100	1.5000	3.3	0.13	47.625	1.8750
795 SERIES															
795	792	120.650	4.7500	47.625	1.8750	3.3	0.13	206.375	8.1250	34.925	1.3750	3.3	0.13	47.625	1.8750
797	792	130.000	5.1181	47.625	1.8750	3.5	0.14	206.375	8.1250	34.925	1.3750	3.3	0.13	47.625	1.8750

$$P = X \cdot Fr + Y \cdot Fa$$

$\frac{Fa}{Fr} \leq e$		$\frac{Fa}{Fr} > e$	
X	Y	X	Y
1	0	0.40	See table

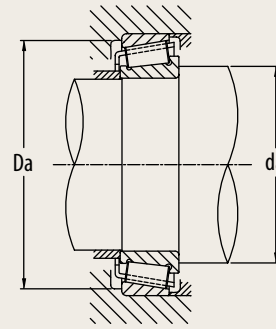

Cone	Cup	Basic Load Rating		a		e	Y Axial Load Factor	Da		da		Reference Speed RPM	Cone Weight Kg	Cup Weight Kg
		Dynamic Cr	Static Cor	Effective Load Center				Housing Bore ID		Shaft OD				
		KN	KN	mm	inch			mm	inch	mm	inch			
655 SERIES														
662	652	203	288	4.5	0.18	0.41	1.47	133	5.24	101	3.98	3500	1.800	1.250
659	653	203	288	7.7	0.30	0.41	1.47	130	5.12	98	3.86	3500	2.110	0.880
663	653	203	288	7.7	0.30	0.41	1.47	130	5.12	101	3.98	3500	1.870	0.880
665	653	203	288	7.7	0.30	0.41	1.47	130	5.12	103	4.06	3500	1.830	0.880
665A	653	203	288	7.7	0.30	0.41	1.47	130	5.12	106	4.17	3500	1.710	0.880
662	653	203	288	4.5	0.18	0.41	1.47	130	5.12	101	3.98	3500	1.800	0.880
675 SERIES														
681	672	219	335	2.6	0.10	0.47	1.28	149	5.87	115	4.53	3000	2.610	1.230
681A	672	219	335	2.6	0.10	0.47	1.28	149	5.87	118	4.65	3000	2.590	1.230
683	672	219	335	2.6	0.10	0.47	1.28	149	5.87	117	4.61	3000	2.460	1.230
683XA	672	219	335	2.6	0.10	0.47	1.28	149	5.87	119	4.69	3000	2.450	1.230
685	672	219	335	2.6	0.10	0.47	1.28	149	5.87	119	4.69	3000	2.330	1.230
687	672	219	335	2.6	0.10	0.47	1.28	149	5.87	120	4.72	3000	2.140	1.230
689	672	219	335	2.6	0.10	0.47	1.28	149	5.87	121	4.76	3000	2.060	1.230
745 SERIES														
740	742	260	361	12.0	0.47	0.33	1.84	134	5.28	102	4.02	3500	2.310	1.060
744	742	260	361	12.0	0.47	0.33	1.84	134	5.28	96	3.78	3500	2.670	1.060
745A	742	260	361	12.0	0.47	0.33	1.84	134	5.28	95	3.74	3500	2.800	1.060
748	742	260	361	12.0	0.47	0.33	1.84	134	5.28	99	3.90	3500	2.360	1.060
749	742	260	361	12.0	0.47	0.33	1.84	134	5.28	102	4.02	3500	2.120	1.060
749-S	742	260	361	12.0	0.47	0.33	1.84	134	5.28	104	4.09	3500	2.120	1.060
749A	742	260	361	12.0	0.47	0.33	1.84	134	5.28	101	3.98	3500	2.240	1.060
750A	742	260	361	12.0	0.47	0.33	1.84	134	5.28	104	4.09	3500	2.220	1.060
755 SERIES														
756A	752	270	384	12.4	0.49	0.34	1.76	143	5.63	107	4.21	3200	2.930	1.600
758	752	270	384	12.4	0.49	0.34	1.76	143	5.63	106	4.17	3200	2.650	1.600
759	752	270	384	12.4	0.49	0.34	1.76	143	5.63	107	4.21	3200	2.490	1.600
760	752	270	384	12.4	0.49	0.34	1.76	143	5.63	108	4.25	3200	2.410	1.600
775 SERIES														
780	772	285	430	8.2	0.32	0.39	1.56	160	6.30	123	4.84	3000	3.050	1.930
795 SERIES														
795	792	313	517	1.9	0.07	0.46	1.31	186	7.32	147	5.79	2000	4.370	1.890
797	792	313	517	1.9	0.07	0.46	1.31	186	7.32	152	5.98	2000	3.680	1.890

INCH SERIES

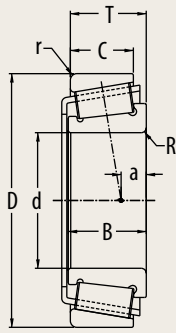

The tables include the most common industry series and sizes in the market. Additional industry series and sizes are available from PEER upon request.

Cone	Cup	d		B		R		D		C		r		T	
		Cone Bore		Cone Width		Max Shaft Radius		Cup Outer Diameter		Cup Width		Max Housing Radius		Total Width	
		mm	inch	mm	inch	mm	inch	mm	inch	mm	inch	mm	inch	mm	inch
835 SERIES															
835	832	69.850	2.7500	56.363	2.2190	3.5	0.14	168.275	6.6250	41.275	1.6250	3.3	0.13	53.975	2.1250
855 SERIES															
855	854	88.900	3.5000	57.531	2.2650	8.0	0.31	190.500	7.5000	44.450	1.7500	3.3	0.13	57.150	2.2500
857	854	92.075	3.6250	57.531	2.2650	8.0	0.31	190.500	7.5000	44.450	1.7500	3.3	0.13	57.150	2.2500
861	854	101.600	4.0000	57.531	2.2650	8.0	0.31	190.500	7.5000	44.450	1.7500	3.3	0.13	57.150	2.2500
864	854	92.250	3.6319	57.531	2.2650	8.0	0.31	190.500	7.5000	44.450	1.7500	3.3	0.13	57.150	2.2500
866	854	98.425	3.8750	57.531	2.2650	3.5	0.14	190.500	7.5000	44.450	1.7500	3.3	0.13	57.150	2.2500
869	854	87.312	3.4375	57.531	2.2650	8.0	0.31	190.500	7.5000	44.450	1.7500	3.3	0.13	57.150	2.2500
935 SERIES															
936	932	107.950	4.2500	66.675	2.6250	8.0	0.31	212.725	8.3750	53.975	2.1250	3.3	0.13	66.675	2.6250
938	932	114.300	4.5000	66.675	2.6250	7.0	0.28	212.725	8.3750	53.975	2.1250	3.3	0.13	66.675	2.6250
1200 SERIES															
1280	1220	22.225	0.8750	22.225	0.8750	0.8	0.03	57.150	2.2500	17.462	0.6875	1.5	0.06	22.225	0.8750
1300 SERIES															
1380	1328	22.225	0.8750	20.168	0.7940	1.5	0.06	52.388	2.0625	14.288	0.5625	1.5	0.06	19.368	0.7625
1700 SERIES															
1755	1729	22.225	0.8750	19.837	0.7810	1.3	0.05	56.896	2.2400	15.875	0.6250	1.3	0.05	19.368	0.7625
1779	1729	23.812	0.9375	19.937	0.7849	0.8	0.03	56.896	2.2400	15.875	0.6250	1.3	0.05	19.368	0.7625
1780	1729	25.400	1.0000	19.837	0.7810	0.8	0.03	56.896	2.2400	15.875	0.6250	1.3	0.05	19.368	0.7625
1755	1729X	22.225	0.8750	19.837	0.7810	1.3	0.05	56.896	2.2400	15.875	0.6250	1.5	0.06	19.368	0.7625
1779	1729X	23.812	0.9375	19.937	0.7849	0.8	0.03	56.896	2.2400	15.875	0.6250	1.5	0.06	19.368	0.7625
1780	1729X	25.400	1.0000	19.837	0.7810	0.8	0.03	56.896	2.2400	15.875	0.6250	1.5	0.06	19.368	0.7625
1900 SERIES															
1986	1922	25.400	1.0000	19.355	0.7620	1.3	0.05	57.150	2.2500	15.875	0.6250	1.5	0.06	19.845	0.7813
2500 SERIES															
2580	2520	31.750	1.2500	25.357	0.9983	0.8	0.03	66.421	2.6150	20.638	0.8125	3.3	0.13	25.400	1.0000
2585	2520	33.338	1.3125	25.357	0.9983	3.5	0.14	66.421	2.6150	20.638	0.8125	3.3	0.13	25.400	1.0000
2580	2523	31.750	1.2500	25.357	0.9983	0.8	0.03	69.850	2.7500	19.050	0.7500	1.3	0.05	23.812	0.9375
2585	2523	33.338	1.3125	25.357	0.9983	3.5	0.14	69.850	2.7500	19.050	0.7500	1.3	0.05	23.812	0.9375
2600 SERIES															
2689	2631	28.575	1.1250	25.433	1.0013	1.3	0.05	66.421	2.6150	19.050	0.7500	1.3	0.05	23.812	0.9375

$$P = X \cdot Fr + Y \cdot Fa$$

$\frac{Fa}{Fr} \leq e$		$\frac{Fa}{Fr} > e$	
X	Y	X	Y
1	0	0.40	See table

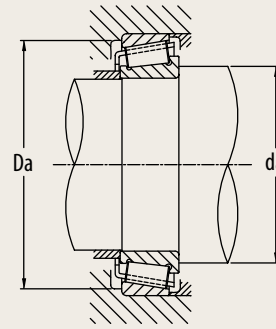

Cone	Cup	Basic Load Rating		a		e	Y Axial Load Factor	Da		da		Reference Speed RPM	Cone Weight Kg	Cup Weight Kg
		Dynamic Cr	Static Cor	Effective Load Center				Housing Bore ID		Shaft OD				
		KN	KN	mm	inch			mm	inch	mm	inch			
835 SERIES														
835	832	339	470	18.5	0.73	0.30	2.00	150	5.91	105	4.13	3000	3.660	1.720
855 SERIES														
855	854	381	557	15.2	0.60	0.34	1.79	168	6.61	118	4.65	3000	4.950	2.660
857	854	381	557	15.2	0.60	0.34	1.79	168	6.61	119	4.69	3000	4.750	2.660
861	854	381	557	15.2	0.60	0.34	1.79	168	6.61	124	4.88	3000	4.090	2.660
864	854	381	557	15.2	0.60	0.34	1.79	168	6.61	121	4.76	3000	4.540	2.660
866	854	381	557	15.2	0.60	0.34	1.79	168	6.61	123	4.84	3000	4.360	2.660
869	854	381	557	15.2	0.60	0.34	1.79	168	6.61	117	4.61	3000	5.050	2.660
935 SERIES														
936	932	446	677	19.1	0.75	0.33	1.84	188	7.40	135	5.31	2500	6.300	4.090
938	932	446	677	19.1	0.75	0.33	1.84	188	7.40	141	5.55	2500	5.730	4.090
1200 SERIES														
1280	1220	49.5	52.7	6.9	0.27	0.35	1.73	49	1.93	31	1.22	9500	0.186	0.105
1300 SERIES														
1380	1328	39.4	41.2	7.7	0.30	0.29	2.05	45	1.77	30	1.18	9500	0.133	0.066
1700 SERIES														
1755	1729	37.3	38.9	6.7	0.26	0.31	1.95	49	1.93	31	1.22	9600	0.151	0.101
1779	1729	37.3	38.9	6.7	0.26	0.31	1.95	49	1.93	31	1.22	9600	0.143	0.101
1780	1729	37.3	38.9	6.7	0.26	0.31	1.95	49	1.93	32	1.26	9600	0.133	0.101
1755	1729X	37.3	38.9	6.7	0.26	0.31	1.95	48	1.89	31	1.22	9600	0.151	0.100
1779	1729X	37.3	38.9	6.7	0.26	0.31	1.95	48	1.89	31	1.22	9600	0.143	0.100
1780	1729X	37.3	38.9	6.7	0.26	0.31	1.95	48	1.89	32	1.26	9600	0.133	0.100
1900 SERIES														
1986	1922	39.3	42.5	5.5	0.22	0.33	1.82	50	1.97	34	1.34	8500	0.158	0.077
2500 SERIES														
2580	2520	69.4	81.8	8.7	0.34	0.27	2.19	57	2.24	40	1.57	7500	0.282	0.121
2585	2520	69.4	81.8	8.7	0.34	0.27	2.19	57	2.24	44	1.73	7500	0.262	0.121
2580	2523	69.4	81.8	8.7	0.34	0.27	2.19	61	2.40	40	1.57	7500	0.282	0.168
2585	2523	69.4	81.8	8.7	0.34	0.27	2.19	61	2.40	44	1.73	7500	0.262	0.168
2600 SERIES														
2689	2631	64	70.8	10.0	0.39	0.25	2.36	57	2.24	37	1.46	8500	0.246	0.164

INCH SERIES

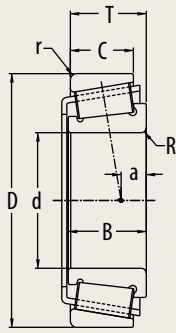

The tables include the most common industry series and sizes in the market. Additional industry series and sizes are available from PEER upon request.

Cone	Cup	d		B		R		D		C		r		T	
		Cone Bore		Cone Width		Max Shaft Radius		Cup Outer Diameter		Cup Width		Max Housing Radius		Total Width	
		mm	inch	mm	inch	mm	inch	mm	inch	mm	inch	mm	inch	mm	inch
2700 SERIES															
2776	2720	38.100	1.5000	25.654	1.0100	4.3	0.17	76.200	3.0000	19.050	0.7500	3.3	0.13	23.812	0.9375
2780	2720	36.487	1.4365	25.654	1.0100	1.5	0.06	76.200	3.0000	19.050	0.7500	3.3	0.13	23.812	0.9375
2788	2720	38.100	1.5000	25.654	1.0100	3.5	0.14	76.200	3.0000	19.050	0.7500	3.3	0.13	23.812	0.9375
2789	2720	39.688	1.5625	25.654	1.0100	3.5	0.14	76.200	3.0000	19.050	0.7500	3.3	0.13	23.812	0.9375
2790	2720	33.338	1.3125	25.654	1.0100	1.5	0.06	76.200	3.0000	19.050	0.7500	3.3	0.13	23.812	0.9375
2793	2720	34.925	1.3750	25.654	1.0100	0.8	0.03	76.200	3.0000	19.050	0.7500	3.3	0.13	23.812	0.9375
2794	2720	36.487	1.4365	25.654	1.0100	3.5	0.14	76.200	3.0000	19.050	0.7500	3.3	0.13	23.812	0.9375
2796	2720	34.925	1.3750	25.654	1.0100	3.5	0.14	76.200	3.0000	19.050	0.7500	3.3	0.13	23.812	0.9375
2776	2729	38.100	1.5000	25.654	1.0100	4.3	0.17	76.200	3.0000	19.050	0.7500	0.8	0.03	23.812	0.9375
2780	2729	36.487	1.4365	25.654	1.0100	1.5	0.06	76.200	3.0000	19.050	0.7500	0.8	0.03	23.812	0.9375
2788	2729	38.100	1.5000	25.654	1.0100	3.5	0.14	76.200	3.0000	19.050	0.7500	0.8	0.03	23.812	0.9375
2789	2729	39.688	1.5625	25.654	1.0100	3.5	0.14	76.200	3.0000	19.050	0.7500	0.8	0.03	23.812	0.9375
2790	2729	33.338	1.3125	25.654	1.0100	1.5	0.06	76.200	3.0000	19.050	0.7500	0.8	0.03	23.812	0.9375
2793	2729	34.925	1.3750	25.654	1.0100	0.8	0.03	76.200	3.0000	19.050	0.7500	0.8	0.03	23.812	0.9375
2794	2729	36.487	1.4365	25.654	1.0100	3.5	0.14	76.200	3.0000	19.050	0.7500	0.8	0.03	23.812	0.9375
2796	2729	34.925	1.3750	25.654	1.0100	3.5	0.14	76.200	3.0000	19.050	0.7500	0.8	0.03	23.812	0.9375
2776	2735X	38.100	1.5000	25.654	1.0100	4.3	0.17	73.025	2.8750	19.050	0.7500	0.8	0.03	23.812	0.9375
2780	2735X	36.487	1.4365	25.654	1.0100	1.5	0.06	73.025	2.8750	19.050	0.7500	0.8	0.03	23.812	0.9375
2788	2735X	38.100	1.5000	25.654	1.0100	3.5	0.14	73.025	2.8750	19.050	0.7500	0.8	0.03	23.812	0.9375
2789	2735X	39.688	1.5625	25.654	1.0100	3.5	0.14	73.025	2.8750	19.050	0.7500	0.8	0.03	23.812	0.9375
2790	2735X	33.338	1.3125	25.654	1.0100	1.5	0.06	73.025	2.8750	19.050	0.7500	0.8	0.03	23.812	0.9375
2793	2735X	34.925	1.3750	25.654	1.0100	0.8	0.03	73.025	2.8750	19.050	0.7500	0.8	0.03	23.812	0.9375
2794	2735X	36.487	1.4365	25.654	1.0100	3.5	0.14	73.025	2.8750	19.050	0.7500	0.8	0.03	23.812	0.9375
2796	2735X	34.925	1.3750	25.654	1.0100	3.5	0.14	73.025	2.8750	19.050	0.7500	0.8	0.03	23.812	0.9375
2900 SERIES															
2984	2924	46.038	1.8125	25.608	1.0082	3.5	0.14	85.000	3.3465	20.638	0.8125	1.3	0.05	25.400	1.0000
3100 SERIES															
3188	3120	31.750	1.2500	29.997	1.1810	0.8	0.03	72.626	2.8593	23.812	0.9375	3.3	0.13	30.162	1.1875
3193	3120	31.750	1.2500	29.997	1.1810	3.5	0.14	72.626	2.8593	23.812	0.9375	3.3	0.13	30.162	1.1875
3196	3120	33.338	1.3125	29.997	1.1810	3.5	0.14	72.626	2.8593	23.812	0.9375	3.3	0.13	30.162	1.1875
3300 SERIES															
3379	3320	34.925	1.3750	30.391	1.1965	3.5	0.14	80.167	3.1562	23.812	0.9375	3.3	0.13	29.370	1.1563
3384	3320	41.275	1.6250	30.391	1.1965	0.8	0.03	80.167	3.1562	23.812	0.9375	3.3	0.13	29.370	1.1563

$$P = X \cdot Fr + Y \cdot Fa$$

$\frac{Fa}{Fr} \leq e$		$\frac{Fa}{Fr} > e$	
X	Y	X	Y
1	0	0.40	See table

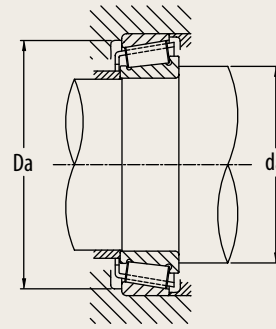

Cone	Cup	Basic Load Rating		a		e	Y Axial Load Factor	Da		da		Reference Speed RPM	Cone Weight Kg	Cup Weight Kg
		Dynamic Cr	Static Cor	Effective Load Center				Housing Bore ID		Shaft OD				
		KN	KN	mm	inch			mm	inch	mm	inch			
2700 SERIES														
2776	2720	71.6	88	8.1	0.32	0.30	1.98	65	2.56	50	1.97	6000	0.305	0.182
2780	2720	71.6	88	8.1	0.32	0.30	1.98	65	2.56	49	1.93	6000	0.329	0.182
2788	2720	71.6	88	8.1	0.32	0.30	1.98	65	2.56	49	1.93	6000	0.307	0.182
2789	2720	71.6	88	8.1	0.32	0.30	1.98	65	2.56	50	1.97	6000	0.287	0.182
2790	2720	71.6	88	8.1	0.32	0.30	1.98	65	2.56	45	1.77	6000	0.363	0.182
2793	2720	71.6	88	8.1	0.32	0.30	1.98	65	2.56	45	1.77	6000	0.347	0.182
2794	2720	71.6	88	8.1	0.32	0.30	1.98	65	2.56	49	1.93	6000	0.326	0.182
2796	2720	71.6	88	8.1	0.32	0.30	1.98	65	2.56	48	1.89	6000	0.344	0.182
2776	2729	71.6	88	8.1	0.32	0.30	1.98	67	2.64	50	1.97	6000	0.305	0.190
2780	2729	71.6	88	8.1	0.32	0.30	1.98	67	2.64	49	1.93	6000	0.329	0.190
2788	2729	71.6	88	8.1	0.32	0.30	1.98	67	2.64	49	1.93	6000	0.307	0.190
2789	2729	71.6	88	8.1	0.32	0.30	1.98	67	2.64	50	1.97	6000	0.287	0.190
2790	2729	71.6	88	8.1	0.32	0.30	1.98	67	2.64	45	1.77	6000	0.363	0.190
2793	2729	71.6	88	8.1	0.32	0.30	1.98	67	2.64	45	1.77	6000	0.347	0.190
2794	2729	71.6	88	8.1	0.32	0.30	1.98	67	2.64	49	1.93	6000	0.326	0.190
2796	2729	71.6	88	8.1	0.32	0.30	1.98	67	2.64	48	1.89	6000	0.344	0.190
2776	2735X	71.6	88	8.1	0.32	0.30	1.98	66	2.60	50	1.97	6000	0.305	0.135
2780	2735X	71.6	88	8.1	0.32	0.30	1.98	66	2.60	49	1.93	6000	0.329	0.135
2788	2735X	71.6	88	8.1	0.32	0.30	1.98	66	2.60	49	1.93	6000	0.307	0.135
2789	2735X	71.6	88	8.1	0.32	0.30	1.98	66	2.60	50	1.97	6000	0.287	0.135
2790	2735X	71.6	88	8.1	0.32	0.30	1.98	66	2.60	45	1.77	6000	0.363	0.135
2793	2735X	71.6	88	8.1	0.32	0.30	1.98	66	2.60	45	1.77	6000	0.347	0.135
2794	2735X	71.6	88	8.1	0.32	0.30	1.98	66	2.60	49	1.93	6000	0.326	0.135
2796	2735X	71.6	88	8.1	0.32	0.30	1.98	66	2.60	48	1.89	6000	0.344	0.135
2900 SERIES														
2984	2924	77	101	6.4	0.25	0.35	1.73	76	2.99	58	2.28	5800	0.384	0.221
3100 SERIES														
3188	3120	78.1	88.3	10.2	0.40	0.33	1.80	61	2.40	41	1.61	7500	0.357	0.220
3193	3120	78.1	88.3	10.2	0.40	0.33	1.80	61	2.40	44	1.73	7500	0.354	0.220
3196	3120	78.1	88.3	10.2	0.40	0.33	1.80	61	2.40	45	1.77	7500	0.335	0.220
3300 SERIES														
3379	3320	94	111	10.9	0.43	0.27	2.20	69	2.72	49	1.93	6000	0.500	0.212
3384	3320	94	111	10.9	0.43	0.27	2.20	69	2.72	50	1.97	6000	0.413	0.212

INCH SERIES

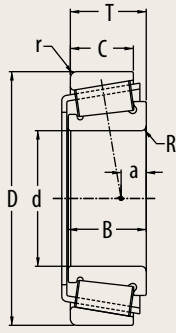

The tables include the most common industry series and sizes in the market. Additional industry series and sizes are available from PEER upon request.

Cone	Cup	d		B		R		D		C		r		T	
		Cone Bore		Cone Width		Max Shaft Radius		Cup Outer Diameter		Cup Width		Max Housing Radius		Total Width	
		mm	inch	mm	inch	mm	inch	mm	inch	mm	inch	mm	inch	mm	inch
3300 SERIES (cont.)															
3386	3320	39.688	1.5625	30.391	1.1965	0.8	0.03	80.167	3.1562	23.812	0.9375	3.3	0.13	29.370	1.1563
3379	3325	34.925	1.3750	30.391	1.1965	3.5	0.14	79.974	3.1486	23.812	0.9375	3.3	0.13	29.370	1.1563
3384	3325	41.275	1.6250	30.391	1.1965	0.8	0.03	79.974	3.1486	23.812	0.9375	3.3	0.13	29.370	1.1563
3386	3325	39.688	1.5625	30.391	1.1965	0.8	0.03	79.974	3.1486	23.812	0.9375	3.3	0.13	29.370	1.1563
3379	3331	34.925	1.3750	30.391	1.1965	3.5	0.14	80.167	3.1562	23.812	0.9375	0.8	0.03	29.370	1.1563
3384	3331	41.275	1.6250	30.391	1.1965	0.8	0.03	80.167	3.1562	23.812	0.9375	0.8	0.03	29.370	1.1563
3386	3331	39.688	1.5625	30.391	1.1965	0.8	0.03	80.167	3.1562	23.812	0.9375	0.8	0.03	29.370	1.1563
3400 SERIES															
3476	3420	31.750	1.2500	29.771	1.1721	1.3	0.05	79.375	3.1250	23.812	0.9375	3.3	0.13	29.370	1.1563
3479	3420	36.512	1.4375	29.771	1.1721	0.8	0.03	79.375	3.1250	23.812	0.9375	3.3	0.13	29.370	1.1563
3482	3420	34.925	1.3750	29.771	1.1721	0.8	0.03	79.375	3.1250	23.812	0.9375	3.3	0.13	29.370	1.1563
3483	3420	33.338	1.3125	29.771	1.1721	0.8	0.03	79.375	3.1250	23.812	0.9375	3.3	0.13	29.370	1.1563
3490	3420	38.100	1.5000	29.771	1.1721	3.5	0.14	79.375	3.1250	23.812	0.9375	3.3	0.13	29.370	1.1563
3500 SERIES															
3578	3520	44.450	1.7500	30.886	1.2160	3.5	0.14	84.138	3.3125	23.812	0.9375	3.3	0.13	30.162	1.1875
3578A	3520	44.450	1.7500	30.886	1.2160	5.5	0.22	84.138	3.3125	23.812	0.9375	3.3	0.13	30.162	1.1875
3580	3520	38.100	1.5000	30.886	1.2160	1.5	0.06	84.138	3.3125	23.812	0.9375	3.3	0.13	30.162	1.1875
3585	3520	41.275	1.6250	30.886	1.2160	1.5	0.06	84.138	3.3125	23.812	0.9375	3.3	0.13	30.162	1.1875
3586	3520	45.237	1.7810	30.886	1.2160	3.5	0.14	84.138	3.3125	23.812	0.9375	3.3	0.13	30.162	1.1875
3578	3525	44.450	1.7500	30.886	1.2160	3.5	0.14	87.312	3.4375	23.812	0.9375	3.3	0.13	30.162	1.1875
3578A	3525	44.450	1.7500	30.886	1.2160	5.5	0.22	87.312	3.4375	23.812	0.9375	3.3	0.13	30.162	1.1875
3580	3525	38.100	1.5000	30.886	1.2160	1.5	0.06	87.312	3.4375	23.812	0.9375	3.3	0.13	30.162	1.1875
3585	3525	41.275	1.6250	30.886	1.2160	1.5	0.06	87.312	3.4375	23.812	0.9375	3.3	0.13	30.162	1.1875
3586	3525	45.237	1.7810	30.886	1.2160	3.5	0.14	87.312	3.4375	23.812	0.9375	3.3	0.13	30.162	1.1875
3700 SERIES															
3767	3720	52.388	2.0625	30.302	1.1930	2.3	0.09	93.264	3.6718	23.812	0.9375	3.3	0.13	30.162	1.1875
3775	3720	50.800	2.0000	30.302	1.1930	0.8	0.03	93.264	3.6718	23.812	0.9375	3.3	0.13	30.162	1.1875
3776	3720	44.983	1.7710	30.302	1.1930	3.5	0.14	93.264	3.6718	23.812	0.9375	3.3	0.13	30.162	1.1875
3778	3720	47.625	1.8750	30.302	1.1930	6.4	0.25	93.264	3.6718	23.812	0.9375	3.3	0.13	30.162	1.1875
3779	3720	47.625	1.8750	30.302	1.1930	3.5	0.14	93.264	3.6718	23.812	0.9375	3.3	0.13	30.162	1.1875
3780	3720	50.800	2.0000	30.302	1.1930	3.5	0.14	93.264	3.6718	23.812	0.9375	3.3	0.13	30.162	1.1875
3781	3720	49.212	1.9375	30.302	1.1930	3.5	0.14	93.264	3.6718	23.812	0.9375	3.3	0.13	30.162	1.1875
3782	3720	44.450	1.7500	30.302	1.1930	3.5	0.14	93.264	3.6718	23.812	0.9375	3.3	0.13	30.162	1.1875

$P = X \cdot Fr + Y \cdot Fa$			
$\frac{Fa}{Fr} \leq e$		$\frac{Fa}{Fr} > e$	
X	Y	X	Y
1	0	0.40	See table

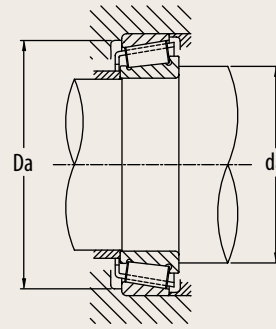

Cone	Cup	Basic Load Rating		a		e	Y Axial Load Factor	Da		da		Reference Speed RPM	Cone Weight Kg	Cup Weight Kg
		Dynamic Cr	Static Cor	Effective Load Center				Housing Bore ID		Shaft OD				
		KN	KN	mm	inch			mm	inch	mm	inch			
3300 SERIES														
3386	3320	94	111	10.9	0.43	0.27	2.20	69	2.72	49	1.93	6000	0.437	0.212
3379	3325	94	111	10.9	0.43	0.27	2.20	69	2.72	49	1.93	6000	0.500	0.207
3384	3325	94	111	10.9	0.43	0.27	2.20	69	2.72	50	1.97	6000	0.413	0.207
3386	3325	94	111	10.9	0.43	0.27	2.20	69	2.72	49	1.93	6000	0.437	0.207
3379	3331	94	111	10.9	0.43	0.27	2.20	72	2.83	49	1.93	6000	0.500	0.220
3384	3331	94	111	10.9	0.43	0.27	2.20	72	2.83	50	1.97	6000	0.413	0.220
3386	3331	94	111	10.9	0.43	0.27	2.20	72	2.83	49	1.93	6000	0.437	0.220
3400 SERIES														
3476	3420	86.7	104	8.5	0.33	0.37	1.64	67	2.64	45	1.77	6500	0.479	0.253
3479	3420	86.7	104	8.5	0.33	0.37	1.64	67	2.64	47	1.85	6500	0.420	0.253
3482	3420	86.7	104	8.5	0.33	0.37	1.64	67	2.64	46	1.81	6500	0.440	0.253
3483	3420	86.7	104	8.5	0.33	0.37	1.64	67	2.64	45	1.77	6500	0.460	0.253
3490	3420	86.7	104	8.5	0.33	0.37	1.64	67	2.64	50	1.97	6500	0.394	0.253
3500 SERIES														
3578	3520	93.4	116	10.1	0.40	0.31	1.96	73	2.87	56	2.20	6000	0.464	0.219
3578A	3520	93.4	116	10.1	0.40	0.31	1.96	73	2.87	58	2.28	6000	0.458	0.219
3580	3520	93.4	116	10.1	0.40	0.31	1.96	73	2.87	51	2.01	6000	0.566	0.219
3585	3520	93.4	116	10.1	0.40	0.31	1.96	73	2.87	53	2.09	6000	0.518	0.219
3586	3520	93.4	116	10.1	0.40	0.31	1.96	73	2.87	57	2.24	6000	0.450	0.219
3578	3525	93.4	116	10.1	0.40	0.31	1.96	75	2.95	56	2.20	6000	0.464	0.298
3578A	3525	93.4	116	10.1	0.40	0.31	1.96	75	2.95	58	2.28	6000	0.458	0.298
3580	3525	93.4	116	10.1	0.40	0.31	1.96	75	2.95	51	2.01	6000	0.566	0.298
3585	3525	93.4	116	10.1	0.40	0.31	1.96	75	2.95	53	2.09	6000	0.518	0.298
3586	3525	93.4	116	10.1	0.40	0.31	1.96	75	2.95	57	2.24	6000	0.450	0.298
3700 SERIES														
3767	3720	101	133	8.1	0.32	0.34	1.77	81	3.19	63	2.48	5500	0.518	0.285
3775	3720	101	133	8.1	0.32	0.34	1.77	81	3.19	61	2.40	5500	0.551	0.285
3776	3720	101	133	8.1	0.32	0.34	1.77	81	3.19	61	2.40	5500	0.650	0.285
3778	3720	101	133	8.1	0.32	0.34	1.77	81	3.19	65	2.56	5500	0.593	0.285
3779	3720	101	133	8.1	0.32	0.34	1.77	81	3.19	62	2.44	5500	0.604	0.285
3780	3720	101	133	8.1	0.32	0.34	1.77	81	3.19	64	2.52	5500	0.546	0.285
3781	3720	101	133	8.1	0.32	0.34	1.77	81	3.19	63	2.48	5500	0.575	0.285
3782	3720	101	133	8.1	0.32	0.34	1.77	81	3.19	61	2.40	5500	0.659	0.285

INCH SERIES

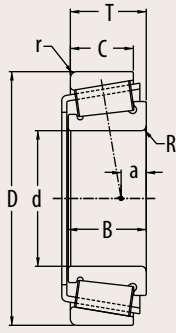

The tables include the most common industry series and sizes in the market. Additional industry series and sizes are available from PEER upon request.

Cone	Cup	d		B		R		D		C		r		T	
		Cone Bore		Cone Width		Max Shaft Radius		Cup Outer Diameter		Cup Width		Max Housing Radius		Total Width	
		mm	inch	mm	inch	mm	inch	mm	inch	mm	inch	mm	inch	mm	inch
3700 SERIES (cont.)															
3783	3720	44.450	1.7500	30.302	1.1930	6.4	0.25	93.264	3.6718	23.812	0.9375	3.3	0.13	30.162	1.1875
3784	3720	50.800	2.0000	30.302	1.1930	6.4	0.25	93.264	3.6718	23.812	0.9375	3.3	0.13	30.162	1.1875
3767	3730	52.388	2.0625	30.302	1.1930	2.3	0.09	93.264	3.6718	23.812	0.9375	0.8	0.03	30.162	1.1875
3775	3730	50.800	2.0000	30.302	1.1930	0.8	0.03	93.264	3.6718	23.812	0.9375	0.8	0.03	30.162	1.1875
3776	3730	44.983	1.7710	30.302	1.1930	3.5	0.14	93.264	3.6718	23.812	0.9375	0.8	0.03	30.162	1.1875
3778	3730	47.625	1.8750	30.302	1.1930	6.4	0.25	93.264	3.6718	23.812	0.9375	0.8	0.03	30.162	1.1875
3779	3730	47.625	1.8750	30.302	1.1930	3.5	0.14	93.264	3.6718	23.812	0.9375	0.8	0.03	30.162	1.1875
3780	3730	50.800	2.0000	30.302	1.1930	3.5	0.14	93.264	3.6718	23.812	0.9375	0.8	0.03	30.162	1.1875
3781	3730	49.212	1.9375	30.302	1.1930	3.5	0.14	93.264	3.6718	23.812	0.9375	0.8	0.03	30.162	1.1875
3782	3730	44.450	1.7500	30.302	1.1930	3.5	0.14	93.264	3.6718	23.812	0.9375	0.8	0.03	30.162	1.1875
3783	3730	44.450	1.7500	30.302	1.1930	6.4	0.25	93.264	3.6718	23.812	0.9375	0.8	0.03	30.162	1.1875
3784	3730	50.800	2.0000	30.302	1.1930	6.4	0.25	93.264	3.6718	23.812	0.9375	0.8	0.03	30.162	1.1875
3800 SERIES															
3872	3820	34.925	1.3750	30.162	1.1875	3.5	0.14	85.725	3.3750	23.812	0.9375	3.3	0.13	30.162	1.1875
3872A	3820	34.925	1.3750	30.162	1.1875	0.8	0.03	85.725	3.3750	23.812	0.9375	3.3	0.13	30.162	1.1875
3877	3820	41.275	1.6250	30.162	1.1875	3.5	0.14	85.725	3.3750	23.812	0.9375	3.3	0.13	30.162	1.1875
3880	3820	41.275	1.6250	30.162	1.1875	0.8	0.03	85.725	3.3750	23.812	0.9375	3.3	0.13	30.162	1.1875
3900 SERIES															
3979	3920	57.150	2.2500	30.048	1.1830	3.5	0.14	112.712	4.4375	23.812	0.9375	3.3	0.13	30.162	1.1875
3980	3920	60.325	2.3750	30.048	1.1830	3.5	0.14	112.712	4.4375	23.812	0.9375	3.3	0.13	30.162	1.1875
3982	3920	63.500	2.5000	30.048	1.1830	3.5	0.14	112.712	4.4375	23.812	0.9375	3.3	0.13	30.162	1.1875
3984	3920	66.675	2.6250	30.048	1.1830	3.5	0.14	112.712	4.4375	23.812	0.9375	3.3	0.13	30.162	1.1875
3994	3920	66.675	2.6250	30.048	1.1830	5.5	0.22	112.712	4.4375	23.812	0.9375	3.3	0.13	30.162	1.1875
3979	3925	57.150	2.2500	30.048	1.1830	3.5	0.14	112.712	4.4375	23.812	0.9375	0.8	0.03	30.162	1.1875
3980	3925	60.325	2.3750	30.048	1.1830	3.5	0.14	112.712	4.4375	23.812	0.9375	0.8	0.03	30.162	1.1875
3982	3925	63.500	2.5000	30.048	1.1830	3.5	0.14	112.712	4.4375	23.812	0.9375	0.8	0.03	30.162	1.1875
3984	3925	66.675	2.6250	30.048	1.1830	3.5	0.14	112.712	4.4375	23.812	0.9375	0.8	0.03	30.162	1.1875
3994	3925	66.675	2.6250	30.048	1.1830	5.5	0.22	112.712	4.4375	23.812	0.9375	0.8	0.03	30.162	1.1875
3979	3926	57.150	2.2500	30.048	1.1830	3.5	0.14	112.712	4.4375	26.988	1.0625	3.3	0.13	33.338	1.3125
3980	3926	60.325	2.3750	30.048	1.1830	3.5	0.14	112.712	4.4375	26.988	1.0625	3.3	0.13	33.338	1.3125
3982	3926	63.500	2.5000	30.048	1.1830	3.5	0.14	112.712	4.4375	26.988	1.0625	3.3	0.13	33.338	1.3125
3984	3926	66.675	2.6250	30.048	1.1830	3.5	0.14	112.712	4.4375	26.988	1.0625	3.3	0.13	33.338	1.3125
3994	3926	66.675	2.6250	30.048	1.1830	5.5	0.22	112.712	4.4375	26.988	1.0625	3.3	0.13	33.338	1.3125

$$P = X \cdot Fr + Y \cdot Fa$$

$\frac{Fa}{Fr} \leq e$		$\frac{Fa}{Fr} > e$	
X	Y	X	Y
1	0	0.40	See table

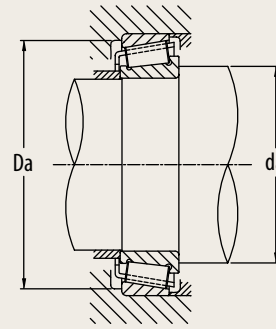

Cone	Cup	Basic Load Rating		a		e	Y Axial Load Factor	Da		da		Reference Speed RPM	Cone Weight Kg	Cup Weight Kg
		Dynamic Cr	Static Cor	Effective Load Center				Housing Bore ID		Shaft OD				
		KN	KN	mm	inch			mm	inch	mm	inch			
3700 SERIES														
3783	3720	101	133	8.1	0.32	0.34	1.77	81	3.19	64	2.52	5500	0.648	0.285
3784	3720	101	133	8.1	0.32	0.34	1.77	81	3.19	67	2.64	5500	0.534	0.285
3767	3730	101	133	8.1	0.32	0.34	1.77	84	3.31	63	2.48	5500	0.518	0.295
3775	3730	101	133	8.1	0.32	0.34	1.77	84	3.31	61	2.40	5500	0.551	0.295
3776	3730	101	133	8.1	0.32	0.34	1.77	84	3.31	61	2.40	5500	0.650	0.295
3778	3730	101	133	8.1	0.32	0.34	1.77	84	3.31	65	2.56	5500	0.593	0.295
3779	3730	101	133	8.1	0.32	0.34	1.77	84	3.31	62	2.44	5500	0.604	0.295
3780	3730	101	133	8.1	0.32	0.34	1.77	84	3.31	64	2.52	5500	0.546	0.295
3781	3730	101	133	8.1	0.32	0.34	1.77	84	3.31	63	2.48	5500	0.575	0.295
3782	3730	101	133	8.1	0.32	0.34	1.77	84	3.31	61	2.40	5500	0.659	0.295
3783	3730	101	133	8.1	0.32	0.34	1.77	84	3.31	64	2.52	5500	0.648	0.295
3784	3730	101	133	8.1	0.32	0.34	1.77	84	3.31	67	2.64	5500	0.534	0.295
3800 SERIES														
3872	3820	101	127	8.1	0.32	0.40	1.49	73	2.87	52	2.05	6000	0.621	0.280
3872A	3820	101	127	8.1	0.32	0.40	1.49	73	2.87	49	1.93	6000	0.624	0.280
3877	3820	101	127	8.1	0.32	0.40	1.49	73	2.87	55	2.17	6000	0.530	0.280
3880	3820	101	127	8.1	0.32	0.40	1.49	73	2.87	53	2.09	6000	0.534	0.280
3900 SERIES														
3979	3920	115	166	4.4	0.17	0.40	1.49	99	3.90	76	2.99	4000	0.931	0.446
3980	3920	115	166	4.4	0.17	0.40	1.49	99	3.90	77	3.03	4000	0.862	0.446
3982	3920	115	166	4.4	0.17	0.40	1.49	99	3.90	79	3.11	4000	0.789	0.446
3984	3920	115	166	4.4	0.17	0.40	1.49	99	3.90	80	3.15	4000	0.713	0.446
3994	3920	115	166	4.4	0.17	0.40	1.49	99	3.90	82	3.23	4000	0.704	0.446
3979	3925	115	166	4.4	0.17	0.40	1.49	101	3.98	76	2.99	4000	0.931	0.457
3980	3925	115	166	4.4	0.17	0.40	1.49	101	3.98	77	3.03	4000	0.862	0.457
3982	3925	115	166	4.4	0.17	0.40	1.49	101	3.98	79	3.11	4000	0.789	0.457
3984	3925	115	166	4.4	0.17	0.40	1.49	101	3.98	80	3.15	4000	0.713	0.457
3994	3925	115	166	4.4	0.17	0.40	1.49	101	3.98	82	3.23	4000	0.704	0.457
3979	3926	115	166	4.4	0.17	0.40	1.49	97	3.82	76	2.99	4000	0.931	0.494
3980	3926	115	166	4.4	0.17	0.40	1.49	97	3.82	77	3.03	4000	0.862	0.494
3982	3926	115	166	4.4	0.17	0.40	1.49	97	3.82	79	3.11	4000	0.789	0.494
3984	3926	115	166	4.4	0.17	0.40	1.49	97	3.82	80	3.15	4000	0.713	0.494
3994	3926	115	166	4.4	0.17	0.40	1.49	97	3.82	82	3.23	4000	0.704	0.494

INCH SERIES

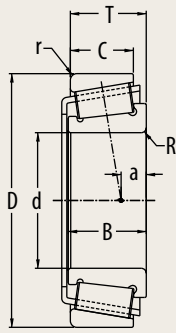

The tables include the most common industry series and sizes in the market. Additional industry series and sizes are available from PEER upon request.

Cone	Cup	d		B		R		D		C		r		T	
		Cone Bore		Cone Width		Max Shaft Radius		Cup Outer Diameter		Cup Width		Max Housing Radius		Total Width	
		mm	inch	mm	inch	mm	inch	mm	inch	mm	inch	mm	inch	mm	inch
4300 SERIES															
4388	4335	41.275	1.6250	40.386	1.5900	3.5	0.14	90.488	3.5625	33.338	1.3125	3.3	0.13	39.687	1.5625
5500 SERIES															
5562	5535	49.212	1.9375	43.764	1.7230	1.3	0.05	122.238	4.8125	36.512	1.4375	3.3	0.13	43.658	1.7188
5565	5535	50.800	2.0000	43.764	1.7230	1.3	0.05	122.238	4.8125	36.512	1.4375	3.3	0.13	43.658	1.7188
5566	5535	55.562	2.1875	43.764	1.7230	1.3	0.05	122.238	4.8125	36.512	1.4375	3.3	0.13	43.658	1.7188
5578	5535	53.975	2.1250	43.764	1.7230	3.5	0.14	122.238	4.8125	36.512	1.4375	3.3	0.13	43.658	1.7188
5582	5535	60.325	2.3750	43.764	1.7230	0.8	0.03	122.238	4.8125	36.512	1.4375	3.3	0.13	43.658	1.7188
5583	5535	60.325	2.3750	43.764	1.7230	3.5	0.14	122.238	4.8125	36.512	1.4375	3.3	0.13	43.658	1.7188
5584	5535	63.500	2.5000	43.764	1.7230	3.5	0.14	122.238	4.8125	36.512	1.4375	3.3	0.13	43.658	1.7188
5595	5535	65.883	2.5938	43.764	1.7230	3.5	0.14	122.238	4.8125	36.512	1.4375	3.3	0.13	43.658	1.7188
5700 SERIES															
5760	5735	76.200	3.0000	46.100	1.8150	3.5	0.14	135.733	5.3438	34.925	1.3750	3.3	0.13	44.450	1.7500
5795	5735	77.788	3.0625	46.100	1.8150	3.5	0.14	135.733	5.3438	34.925	1.3750	3.3	0.13	44.450	1.7500
A6000 SERIES															
A6075	A6157	19.050	0.7500	11.153	0.4391	1.0	0.04	39.992	1.5745	9.525	0.3750	1.3	0.05	12.014	0.4730
6300 SERIES															
6376	6320	60.325	2.3750	56.007	2.2050	3.5	0.14	135.755	5.3447	44.450	1.7500	3.3	0.13	53.975	2.1250
6379	6320	65.088	2.5625	56.007	2.2050	3.5	0.14	135.755	5.3447	44.450	1.7500	3.3	0.13	53.975	2.1250
6381	6320	54.988	2.1649	56.007	2.2050	3.5	0.14	135.755	5.3447	44.450	1.7500	3.3	0.13	53.975	2.1250
6382	6320	63.500	2.5000	56.007	2.2050	4.3	0.17	135.755	5.3447	44.450	1.7500	3.3	0.13	53.975	2.1250
6386	6320	66.675	2.6250	56.007	2.2050	4.3	0.17	135.755	5.3447	44.450	1.7500	3.3	0.13	53.975	2.1250
6389	6320	66.675	2.6250	56.007	2.2050	6.4	0.25	135.755	5.3447	44.450	1.7500	3.3	0.13	53.975	2.1250
6400 SERIES															
6455	6420	57.150	2.2500	54.229	2.1350	3.5	0.14	149.225	5.8750	44.450	1.7500	3.3	0.13	53.975	2.1250
6461A	6420	76.200	3.0000	54.229	2.1350	9.7	0.38	149.225	5.8750	44.450	1.7500	3.3	0.13	53.975	2.1250
6500 SERIES															
6576	6535	76.200	3.0000	55.100	2.1693	3.5	0.14	161.925	6.3750	42.862	1.6875	3.3	0.13	53.974	2.1250
6580	6535	88.900	3.5000	55.100	2.1693	3.5	0.14	161.925	6.3750	42.862	1.6875	3.3	0.13	53.974	2.1250
9200 SERIES															
9285	9220	76.200	3.0000	46.038	1.8125	3.5	0.14	161.925	6.3750	31.750	1.2500	3.3	0.13	49.212	1.9375

$$P = X \cdot Fr + Y \cdot Fa$$

$\frac{Fa}{Fr} \leq e$		$\frac{Fa}{Fr} > e$	
X	Y	X	Y
1	0	0.40	See table

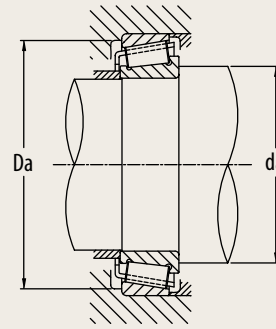

Cone	Cup	Basic Load Rating		a		e	Y Axial Load Factor	Da		da		Reference Speed RPM	Cone Weight Kg	Cup Weight Kg
		Dynamic Cr	Static Cor	Effective Load Center				Housing Bore ID		Shaft OD				
		KN	KN	mm	inch			mm	inch	mm	inch			
4300 SERIES														
4388	4335	129	163	15.3	0.60	0.28	2.11	77	3.03	56	2.20	6500	0.761	0.453
5500 SERIES														
5562	5535	215	306	12.5	0.49	0.36	1.67	106	4.17	72	2.83	3800	1.940	0.806
5565	5535	215	306	12.5	0.49	0.36	1.67	106	4.17	73	2.87	3800	1.900	0.806
5566	5535	215	306	12.5	0.49	0.36	1.67	106	4.17	75	2.95	3800	1.760	0.806
5578	5535	215	306	12.5	0.49	0.36	1.67	106	4.17	77	3.03	3800	1.800	0.806
5582	5535	215	306	12.5	0.49	0.36	1.67	106	4.17	77	3.03	3800	1.610	0.806
5583	5535	215	306	12.5	0.49	0.36	1.67	106	4.17	80	3.15	3800	1.610	0.806
5584	5535	215	306	12.5	0.49	0.36	1.67	106	4.17	81	3.19	3800	1.500	0.806
5595	5535	215	306	12.5	0.49	0.36	1.67	106	4.17	82	3.23	3800	1.420	0.806
5700 SERIES														
5760	5735	227	343	11.7	0.46	0.41	1.48	119	4.69	95	3.74	3800	1.880	0.836
5795	5735	227	343	11.7	0.46	0.41	1.48	119	4.69	96	3.78	3800	1.810	0.836
A6000 SERIES														
A6075	A6157	11.5	11.2	1.9	0.07	0.53	1.14	33	1.30	25	0.98	12000	0.035	0.032
6300 SERIES														
6376	6320	263	351	19.2	0.76	0.32	1.85	117	4.61	81	3.19	4500	2.420	1.380
6379	6320	263	351	19.2	0.76	0.32	1.85	117	4.61	83	3.27	4500	2.210	1.380
6381	6320	263	351	19.2	0.76	0.32	1.85	117	4.61	78	3.07	4500	2.630	1.380
6382	6320	263	351	19.2	0.76	0.32	1.85	117	4.61	82	3.23	4500	2.280	1.380
6386	6320	263	351	19.2	0.76	0.32	1.85	117	4.61	84	3.31	4500	2.140	1.380
6389	6320	263	351	19.2	0.76	0.32	1.85	117	4.61	84	3.31	4500	2.120	1.380
6400 SERIES														
6455	6420	284	403	14.5	0.57	0.36	1.66	130	5.12	87	3.43	4000	3.470	1.620
6461A	6420	284	403	14.5	0.57	0.36	1.66	130	5.12	102	4.02	4000	2.570	1.620
6500 SERIES														
6576	6535	329	505	13.3	0.52	0.40	1.50	142	5.59	103	4.06	3000	3.930	1.660
6580	6535	329	505	13.3	0.52	0.40	1.50	142	5.59	110	4.33	3000	3.220	1.660
9200 SERIES														
9285	9220	245	287	-0.3	-0.01	0.71	0.85	139	5.47	99	3.90	2400	2.790	1.380

INCH SERIES

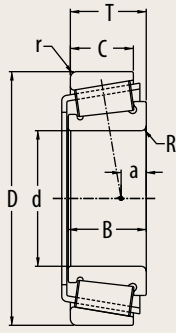

The tables include the most common industry series and sizes in the market. Additional industry series and sizes are available from PEER upon request.

Cone	Cup	d		B		R		D		C		r		T	
		Cone Bore		Cone Width		Max Shaft Radius		Cup Outer Diameter		Cup Width		Max Housing Radius		Total Width	
		mm	inch	mm	inch	mm	inch	mm	inch	mm	inch	mm	inch	mm	inch
02400 SERIES															
02474	02420	28.575	1.1250	23.812	0.9375	0.8	0.03	68.262	2.6875	17.462	0.6875	1.5	0.06	22.225	0.8750
02475	02420	31.750	1.2500	23.812	0.9375	3.5	0.14	68.262	2.6875	17.462	0.6875	1.5	0.06	22.225	0.8750
02474	02421	28.575	1.1250	23.812	0.9375	0.8	0.03	68.262	2.6875	17.462	0.6875	0.8	0.03	22.225	0.8750
02475	02421	31.750	1.2500	23.812	0.9375	3.5	0.14	68.262	2.6875	17.462	0.6875	0.8	0.03	22.225	0.8750
02800 SERIES															
02872	02820	28.575	1.1250	22.225	0.8750	0.8	0.03	73.025	2.8750	17.462	0.6875	3.3	0.13	22.225	0.8750
02875	02820	31.750	1.2500	22.225	0.8750	3.5	0.14	73.025	2.8750	17.462	0.6875	3.3	0.13	22.225	0.8750
05000 SERIES															
05062	05185	15.875	0.6250	14.381	0.5662	1.5	0.06	47.000	1.8504	11.112	0.4375	1.3	0.05	14.381	0.5662
07000 SERIES															
07079	07196	20.000	0.7874	14.260	0.5614	1.5	0.06	50.005	1.9687	9.525	0.3750	1.0	0.04	13.495	0.5313
07087	07196	22.225	0.8750	14.260	0.5614	1.3	0.05	50.005	1.9687	9.525	0.3750	1.0	0.04	13.495	0.5313
07093	07196	23.812	0.9375	14.260	0.5614	1.5	0.06	50.005	1.9687	9.525	0.3750	1.0	0.04	13.495	0.5313
07097	07196	25.000	0.9843	14.260	0.5614	1.5	0.06	50.005	1.9687	9.525	0.3750	1.0	0.04	13.495	0.5313
07100	07196	25.400	1.0000	14.260	0.5614	1.0	0.04	50.005	1.9687	9.525	0.3750	1.0	0.04	13.495	0.5313
07079	07204	20.000	0.7874	14.260	0.5614	1.5	0.06	51.994	2.0470	12.700	0.5000	1.3	0.05	15.011	0.5910
07087	07204	22.225	0.8750	14.260	0.5614	1.3	0.05	51.994	2.0470	12.700	0.5000	1.3	0.05	15.011	0.5910
07093	07204	23.812	0.9375	14.260	0.5614	1.5	0.06	51.994	2.0470	12.700	0.5000	1.3	0.05	15.011	0.5910
07097	07204	25.000	0.9843	14.260	0.5614	1.5	0.06	51.994	2.0470	12.700	0.5000	1.3	0.05	15.011	0.5910
07100	07204	25.400	1.0000	14.260	0.5614	1.0	0.04	51.994	2.0470	12.700	0.5000	1.3	0.05	15.011	0.5910
07079	07210X	20.000	0.7874	14.260	0.5614	1.5	0.06	50.800	2.0000	12.700	0.5000	1.5	0.06	15.011	0.5910
07087	07210X	22.225	0.8750	14.260	0.5614	1.3	0.05	50.800	2.0000	12.700	0.5000	1.5	0.06	15.011	0.5910
07093	07210X	23.812	0.9375	14.260	0.5614	1.5	0.06	50.800	2.0000	12.700	0.5000	1.5	0.06	15.011	0.5910
07097	07210X	25.000	0.9843	14.260	0.5614	1.5	0.06	50.800	2.0000	12.700	0.5000	1.5	0.06	15.011	0.5910
07100	07210X	25.400	1.0000	14.260	0.5614	1.0	0.04	50.800	2.0000	12.700	0.5000	1.5	0.06	15.011	0.5910
08000 SERIES															
08125	08231	31.750	1.2500	15.080	0.5937	1.0	0.04	58.738	2.3125	10.716	0.4219	1.0	0.04	14.683	0.5781
09000 SERIES															
09078	09194	19.050	0.7500	21.539	0.8480	1.3	0.05	49.225	1.9380	17.462	0.6875	3.5	0.14	23.020	0.9063
09067	09194	19.050	0.7500	19.050	0.7500	1.3	0.05	49.225	1.9380	17.462	0.6875	3.5	0.14	21.209	0.8350
09074	09194	19.050	0.7500	21.539	0.8480	SP	SP	49.225	1.9380	17.462	0.6875	3.5	0.14	23.020	0.9063
09078	09195	19.050	0.7500	21.539	0.8480	1.3	0.05	49.225	1.9380	14.288	0.5625	1.3	0.05	19.845	0.7813
09067	09195	19.050	0.7500	19.050	0.7500	1.3	0.05	49.225	1.9380	14.288	0.5625	1.3	0.05	18.034	0.7100

$$P = X \cdot Fr + Y \cdot Fa$$

$\frac{Fa}{Fr} \leq e$		$\frac{Fa}{Fr} > e$	
X	Y	X	Y
1	0	0.40	See table

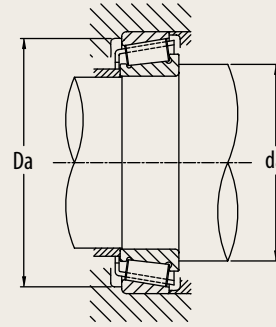

Cone	Cup	Basic Load Rating		a		e	Y Axial Load Factor	Da		da		Reference Speed RPM	Cone Weight Kg	Cup Weight Kg
		Dynamic Cr	Static Cor	Effective Load Center				Housing Bore ID		Shaft OD				
		KN	KN	mm	inch			mm	inch	mm	inch			
02400 SERIES														
02474	02420	61.6	82.5	5.1	0.20	0.34	1.77	60	2.36	41	1.61	6000	0.322	0.126
02475	02420	61.6	82.5	5.1	0.20	0.34	1.77	60	2.36	45	1.77	6000	0.291	0.126
02474	02421	61.6	82.5	5.1	0.20	0.34	1.77	60	2.36	41	1.61	6000	0.322	0.127
02475	02421	61.6	82.5	5.1	0.20	0.34	1.77	60	2.36	45	1.77	6000	0.291	0.127
02800 SERIES														
02872	02820	55.9	67	3.7	0.15	0.45	1.32	61	2.40	42	1.65	6500	0.324	0.155
02875	02820	55.9	67	3.7	0.15	0.45	1.32	61	2.40	46	1.81	6500	0.295	0.155
05000 SERIES														
05062	05185	23.3	23.1	4.1	0.16	0.36	1.68	40	1.57	25	0.98	10000	0.083	0.047
07000 SERIES														
07079	07196	24.7	26	2.7	0.11	0.40	1.49	44	1.73	29	1.14	8000	0.100	0.035
07087	07196	24.7	26	2.7	0.11	0.40	1.49	44	1.73	30	1.18	8000	0.092	0.035
07093	07196	24.7	26	2.7	0.11	0.40	1.49	44	1.73	31	1.22	8000	0.086	0.035
07097	07196	24.7	26	2.7	0.11	0.40	1.49	44	1.73	32	1.26	8000	0.081	0.035
07100	07196	24.7	26	2.7	0.11	0.40	1.49	44	1.73	32	1.26	8000	0.079	0.035
07079	07204	24.7	26	2.7	0.11	0.40	1.49	44	1.73	29	1.14	8000	0.100	0.061
07087	07204	24.7	26	2.7	0.11	0.40	1.49	44	1.73	30	1.18	8000	0.092	0.061
07093	07204	24.7	26	2.7	0.11	0.40	1.49	44	1.73	31	1.22	8000	0.086	0.061
07097	07204	24.7	26	2.7	0.11	0.40	1.49	44	1.73	32	1.26	8000	0.081	0.061
07100	07204	24.7	26	2.7	0.11	0.40	1.49	44	1.73	32	1.26	8000	0.079	0.061
07079	07210X	24.7	26	2.7	0.11	0.40	1.49	44	1.73	29	1.14	8000	0.100	0.051
07087	07210X	24.7	26	2.7	0.11	0.40	1.49	44	1.73	30	1.18	8000	0.092	0.051
07093	07210X	24.7	26	2.7	0.11	0.40	1.49	44	1.73	31	1.22	8000	0.086	0.051
07097	07210X	24.7	26	2.7	0.11	0.40	1.49	44	1.73	32	1.26	8000	0.081	0.051
07100	07210X	24.7	26	2.7	0.11	0.40	1.49	44	1.73	32	1.26	8000	0.079	0.051
08000 SERIES														
08125	08231	27.2	31.6	1.1	0.04	0.47	1.27	52	2.05	39	1.54	7500	0.109	0.057
09000 SERIES														
09078	09194	35.4	34.8	9.1	0.36	0.27	2.26	39	1.54	26	1.02	11000	0.118	0.080
09067	09194	35.4	34.8	7.3	0.29	0.27	2.26	39	1.54	25	0.98	11000	0.108	0.080
09074	09194	35.4	34.8	9.1	0.36	0.27	2.26	39	1.54	26	1.02	11000	0.117	0.080
09078	09195	35.4	34.8	9.1	0.36	0.27	2.26	42	1.65	26	1.02	11000	0.118	0.065
09067	09195	35.4	34.8	7.3	0.29	0.27	2.26	42	1.65	25	0.98	11000	0.108	0.065

INCH SERIES

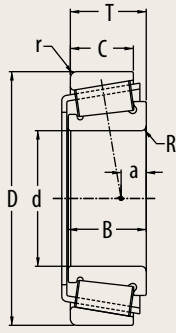

The tables include the most common industry series and sizes in the market. Additional industry series and sizes are available from PEER upon request.

Cone	Cup	d		B		R		D		C		r		T	
		Cone Bore		Cone Width		Max Shaft Radius		Cup Outer Diameter		Cup Width		Max Housing Radius		Total Width	
		mm	inch	mm	inch	mm	inch	mm	inch	mm	inch	mm	inch	mm	inch
09000 SERIES (cont.)															
09074	09195	19.050	0.7500	21.539	0.8480	SP	SP	49.225	1.9380	14.288	0.5625	1.3	0.05	19.845	0.7813
09078	09196	19.050	0.7500	21.539	0.8480	1.3	0.05	49.225	1.9380	17.462	0.6875	1.5	0.06	23.020	0.9063
09067	09196	19.050	0.7500	19.050	0.7500	1.3	0.05	49.225	1.9380	17.462	0.6875	1.5	0.06	21.209	0.8350
09074	09196	19.050	0.7500	21.539	0.8480	SP	SP	49.225	1.9380	17.462	0.6875	1.5	0.06	23.020	0.9063
11000 SERIES															
11162	11300	41.275	1.6250	17.384	0.6844	1.5	0.06	76.200	3.0000	14.288	0.5625	1.5	0.06	18.009	0.7090
11500 SERIES															
11590	11520	15.875	0.6250	14.288	0.5625	1.5	0.06	42.862	1.6875	9.525	0.3750	1.5	0.06	14.287	0.5625
LM11700 SERIES															
LM11749	LM11710	17.462	0.6875	14.605	0.5750	1.3	0.05	39.878	1.5700	10.668	0.4200	1.3	0.05	13.843	0.5450
LM11900 SERIES															
LM11949	LM11910	19.050	0.7500	16.637	0.6550	1.3	0.05	45.237	1.7810	12.065	0.4750	1.3	0.05	15.494	0.6100
12000 SERIES															
12175	12303	44.450	1.7500	17.145	0.6750	1.5	0.06	76.992	3.0312	11.908	0.4688	1.5	0.06	17.464	0.6876
12500 SERIES															
12580	12520	20.638	0.8125	19.845	0.7813	1.5	0.06	49.225	1.9380	15.875	0.6250	1.5	0.06	19.845	0.7813
M12600 SERIES															
M12648	M12610	22.225	0.8750	18.288	0.7200	1.3	0.05	50.005	1.9687	13.970	0.5500	1.3	0.05	17.526	0.6900
M12649	M12610	21.430	0.8437	18.288	0.7200	1.3	0.05	50.005	1.9687	13.970	0.5500	1.3	0.05	17.526	0.6900
LM12700 SERIES															
LM12748	LM12710	21.430	0.8437	16.637	0.6550	1.3	0.05	45.237	1.7810	12.065	0.4750	1.3	0.05	15.494	0.6100
LM12749	LM12710	21.986	0.8656	16.637	0.6550	1.3	0.05	45.237	1.7810	12.065	0.4750	1.3	0.05	15.494	0.6100
LM12748	LM12711	21.430	0.8437	16.637	0.6550	1.3	0.05	45.974	1.8100	12.065	0.4750	1.3	0.05	15.494	0.6100
LM12749	LM12711	21.986	0.8656	16.637	0.6550	1.3	0.05	45.974	1.8100	12.065	0.4750	1.3	0.05	15.454	0.6084
13600 SERIES															
13685	13620	38.100	1.5000	19.050	0.7500	3.5	0.14	69.012	2.7170	15.083	0.5938	0.8	0.03	19.050	0.7500
13687	13620	38.100	1.5000	19.050	0.7500	2.0	0.08	69.012	2.7170	15.083	0.5938	0.8	0.03	19.050	0.7500
13685	13621	38.100	1.5000	19.050	0.7500	3.5	0.14	69.012	2.7170	15.083	0.5938	2.3	0.09	19.050	0.7500
13687	13621	38.100	1.5000	19.050	0.7500	2.0	0.08	69.012	2.7170	15.083	0.5938	2.3	0.09	19.050	0.7500
14000 SERIES															
14116	14274	30.226	1.1900	19.583	0.7710	0.8	0.03	69.012	2.7170	15.875	0.6250	3.3	0.13	19.845	0.7813
14125A	14274	31.750	1.2500	19.583	0.7710	3.5	0.14	69.012	2.7170	15.875	0.6250	3.3	0.13	19.845	0.7813
14131	14274	33.338	1.3125	19.583	0.7710	0.8	0.03	69.012	2.7170	15.875	0.6250	3.3	0.13	19.845	0.7813

$$P = X \cdot Fr + Y \cdot Fa$$

$\frac{Fa}{Fr} \leq e$		$\frac{Fa}{Fr} > e$	
X	Y	X	Y
1	0	0.40	See table

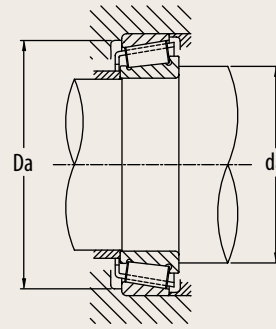

Cone	Cup	Basic Load Rating		a		e	Y Axial Load Factor	Da		da		Reference Speed RPM	Cone Weight Kg	Cup Weight Kg
		Dynamic Cr	Static Cor	Effective Load Center				Housing Bore ID		Shaft OD				
		KN	KN	mm	inch			mm	inch	mm	inch			
09000 SERIES														
09074	09195	35.4	34.8	9.1	0.36	0.27	2.26	42	1.65	26	1.02	11000	0.117	0.065
09078	09196	35.4	34.8	9.1	0.36	0.27	2.26	42	1.65	26	1.02	11000	0.118	0.085
09067	09196	35.4	34.8	7.3	0.29	0.27	2.26	42	1.65	25	0.98	11000	0.108	0.085
09074	09196	35.4	34.8	9.1	0.36	0.27	2.26	42	1.65	26	1.02	11000	0.117	0.085
11000 SERIES														
11162	11300	48.3	57.9	1.0	0.04	0.49	1.23	67	2.64	51	2.01	6000	0.208	0.128
11500 SERIES														
11590	11520	16	15.5	1.2	0.05	0.70	0.85	34	1.34	24	0.94	13000	0.059	0.040
LM11700 SERIES														
LM11749	LM11710	21	20.5	5.0	0.20	0.29	2.10	34	1.34	24	0.94	12000	0.055	0.028
LM11900 SERIES														
LM11949	LM11910	27.6	27.7	5.6	0.22	0.30	2.00	39	1.54	26	1.02	11000	0.078	0.044
12000 SERIES														
12175	12303	42.6	52.2	0.0	0.00	0.51	1.19	68	2.68	54	2.13	5500	0.202	0.098
12500 SERIES														
12580	12520	35.2	36.1	7.2	0.28	0.32	1.86	42	1.65	28	1.10	11000	0.112	0.067
M12600 SERIES														
M12648	M12610	36.6	37.5	6.3	0.25	0.28	2.16	44	1.73	29	1.14	10000	0.106	0.059
M12649	M12610	36.6	37.5	6.3	0.25	0.28	2.16	44	1.73	28	1.10	10000	0.110	0.059
LM12700 SERIES														
LM12748	LM12710	27.4	30.8	5.3	0.21	0.31	1.96	39	1.54	28	1.10	10000	0.080	0.038
LM12749	LM12710	27.4	30.8	5.3	0.21	0.31	1.96	39	1.54	28	1.10	10000	0.078	0.038
LM12748	LM12711	27.4	30.8	5.3	0.21	0.31	1.96	40	1.57	28	1.10	10000	0.080	0.043
LM12749	LM12711	27.4	30.8	5.3	0.21	0.31	1.96	40	1.57	28	1.10	10000	0.078	0.043
13600 SERIES														
13685	13620	46.8	57.9	2.9	0.11	0.40	1.49	60	2.36	48	1.89	6500	0.184	0.105
13687	13620	46.8	57.9	2.9	0.11	0.40	1.49	60	2.36	47	1.85	6500	0.187	0.105
13685	13621	46.8	57.9	2.9	0.11	0.40	1.49	60	2.36	48	1.89	6500	0.184	0.101
13687	13621	46.8	57.9	2.9	0.11	0.40	1.49	60	2.36	47	1.85	6500	0.187	0.101
14000 SERIES														
14116	14274	46	54.5	4.3	0.17	0.38	1.57	58	2.28	41	1.61	7000	0.232	0.128
14125A	14274	46	54.5	4.3	0.17	0.38	1.57	58	2.28	44	1.73	7000	0.207	0.128
14131	14274	46	54.5	4.3	0.17	0.38	1.57	58	2.28	42	1.65	7000	0.208	0.128

INCH SERIES

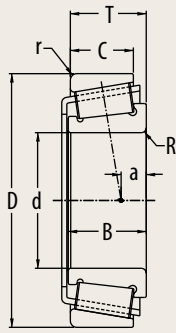

The tables include the most common industry series and sizes in the market. Additional industry series and sizes are available from PEER upon request.

Cone	Cup	d		B		R		D		C		r		T	
		Cone Bore		Cone Width		Max Shaft Radius		Cup Outer Diameter		Cup Width		Max Housing Radius		Total Width	
		mm	inch	mm	inch	mm	inch	mm	inch	mm	inch	mm	inch	mm	inch
14000 SERIES (cont.)															
14137A	14274	34.925	1.3750	19.583	0.7710	1.5	0.06	69.012	2.7170	15.875	0.6250	3.3	0.13	19.845	0.7813
14138A	14274	34.925	1.3750	19.583	0.7710	3.5	0.14	69.012	2.7170	15.875	0.6250	3.3	0.13	19.845	0.7813
14139	14274	34.976	1.3770	19.583	0.7710	1.3	0.05	69.012	2.7170	15.875	0.6250	3.3	0.13	19.845	0.7813
14116	14276	30.226	1.1900	19.583	0.7710	0.8	0.03	69.012	2.7170	15.875	0.6250	1.3	0.05	19.845	0.7813
14125A	14276	31.750	1.2500	19.583	0.7710	3.5	0.14	69.012	2.7170	15.875	0.6250	1.3	0.05	19.845	0.7813
14131	14276	33.338	1.3125	19.583	0.7710	0.8	0.03	69.012	2.7170	15.875	0.6250	1.3	0.05	19.845	0.7813
14137A	14276	34.925	1.3750	19.583	0.7710	1.5	0.06	69.012	2.7170	15.875	0.6250	1.3	0.05	19.845	0.7813
14138A	14276	34.925	1.3750	19.583	0.7710	3.5	0.14	69.012	2.7170	15.875	0.6250	1.3	0.05	19.845	0.7813
14139	14276	34.976	1.3770	19.583	0.7710	1.3	0.05	69.012	2.7170	15.875	0.6250	1.3	0.05	19.845	0.7813
14116	14277	30.226	1.1900	19.583	0.7710	0.8	0.03	69.012	2.7170	18.415	0.7250	2.3	0.09	22.385	0.8813
14125A	14277	31.750	1.2500	19.583	0.7710	3.5	0.14	69.012	2.7170	18.415	0.7250	2.3	0.09	22.385	0.8813
14131	14277	33.338	1.3125	19.583	0.7710	0.8	0.03	69.012	2.7170	18.415	0.7250	2.3	0.09	22.385	0.8813
14137A	14277	34.925	1.3750	19.583	0.7710	1.5	0.06	69.012	2.7170	18.415	0.7250	2.3	0.09	22.385	0.8813
14138A	14277	34.925	1.3750	19.583	0.7710	3.5	0.14	69.012	2.7170	18.415	0.7250	2.3	0.09	22.385	0.8813
14139	14277	34.976	1.3770	19.583	0.7710	1.3	0.05	69.012	2.7170	18.415	0.7250	2.3	0.09	22.385	0.8813
15000 SERIES															
15100	15243	25.400	1.0000	20.638	0.8125	3.5	0.14	61.912	2.4375	14.288	0.5625	2.0	0.08	19.050	0.7500
15101	15243	25.400	1.0000	20.638	0.8125	0.8	0.03	61.912	2.4375	14.288	0.5625	2.0	0.08	19.050	0.7500
15102	15243	25.400	1.0000	20.638	0.8125	1.5	0.06	61.912	2.4375	14.288	0.5625	2.0	0.08	19.050	0.7500
15103-S	15243	26.162	1.0300	19.939	0.7850	0.8	0.03	61.912	2.4375	14.288	0.5625	2.0	0.08	19.050	0.7500
15106	15243	26.988	1.0625	20.638	0.8125	0.8	0.03	61.912	2.4375	14.288	0.5625	2.0	0.08	19.050	0.7500
15112	15243	28.575	1.1250	20.638	0.8125	3.5	0.14	61.912	2.4375	14.288	0.5625	2.0	0.08	19.050	0.7500
15113	15243	28.575	1.1250	20.638	0.8125	0.8	0.03	61.912	2.4375	14.288	0.5625	2.0	0.08	19.050	0.7500
15116	15243	30.112	1.1855	20.638	0.8125	0.8	0.03	61.912	2.4375	14.288	0.5625	2.0	0.08	19.050	0.7500
15117	15243	29.987	1.1806	20.638	0.8125	1.3	0.05	61.912	2.4375	14.288	0.5625	2.0	0.08	19.050	0.7500
15118	15243	30.213	1.1895	20.638	0.8125	3.5	0.14	61.912	2.4375	14.288	0.5625	2.0	0.08	19.050	0.7500
15119	15243	30.213	1.1895	20.638	0.8125	1.5	0.06	61.912	2.4375	14.288	0.5625	2.0	0.08	19.050	0.7500
15120	15243	30.213	1.1895	20.638	0.8125	0.8	0.03	61.912	2.4375	14.288	0.5625	2.0	0.08	19.050	0.7500
15123	15243	31.750	1.2500	19.050	0.7500	SP	SP	61.912	2.4375	14.288	0.5625	2.0	0.08	18.161	0.7150
15125	15243	31.750	1.2500	20.638	0.8125	3.5	0.14	61.912	2.4375	14.288	0.5625	2.0	0.08	19.050	0.7500
15126	15243	31.750	1.2500	20.638	0.8125	0.8	0.03	61.912	2.4375	14.288	0.5625	2.0	0.08	19.050	0.7500
15100	15245	25.400	1.0000	20.638	0.8125	3.5	0.14	62.000	2.4409	14.288	0.5625	1.3	0.05	19.050	0.7500
15101	15245	25.400	1.0000	20.638	0.8125	0.8	0.03	62.000	2.4409	14.288	0.5625	1.3	0.05	19.050	0.7500
15102	15245	25.400	1.0000	20.638	0.8125	1.5	0.06	62.000	2.4409	14.288	0.5625	1.3	0.05	19.050	0.7500

$$P = X \cdot Fr + Y \cdot Fa$$

$\frac{Fa}{Fr} \leq e$		$\frac{Fa}{Fr} > e$	
X	Y	X	Y
1	0	0.40	See table

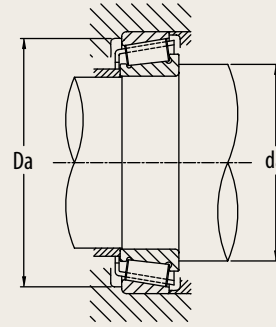

Cone	Cup	Basic Load Rating		a		e	Y Axial Load Factor	Da		da		Reference Speed RPM	Cone Weight Kg	Cup Weight Kg
		Dynamic Cr	Static Cor	Effective Load Center				Housing Bore ID		Shaft OD				
		KN	KN	mm	inch			mm	inch	mm	inch			
14000 SERIES														
14137A	14274	46	54.5	4.3	0.17	0.38	1.57	58	2.28	44	1.73	7000	0.195	0.128
14138A	14274	46	54.5	4.3	0.17	0.38	1.57	58	2.28	46	1.81	7000	0.192	0.128
14139	14274	46	54.5	4.3	0.17	0.38	1.57	58	2.28	44	1.73	7000	0.195	0.128
14116	14276	46	54.5	4.3	0.17	0.38	1.57	60	2.36	41	1.61	7000	0.232	0.134
14125A	14276	46	54.5	4.3	0.17	0.38	1.57	60	2.36	44	1.73	7000	0.207	0.134
14131	14276	46	54.5	4.3	0.17	0.38	1.57	60	2.36	42	1.65	7000	0.208	0.134
14137A	14276	46	54.5	4.3	0.17	0.38	1.57	60	2.36	44	1.73	7000	0.195	0.134
14138A	14276	46	54.5	4.3	0.17	0.38	1.57	60	2.36	46	1.81	7000	0.192	0.134
14139	14276	46	54.5	4.3	0.17	0.38	1.57	60	2.36	44	1.73	7000	0.195	0.134
14116	14277	46	54.5	4.3	0.17	0.38	1.57	58	2.28	41	1.61	7000	0.232	0.161
14125A	14277	46	54.5	4.3	0.17	0.38	1.57	58	2.28	44	1.73	7000	0.207	0.161
14131	14277	46	54.5	4.3	0.17	0.38	1.57	58	2.28	42	1.65	7000	0.208	0.161
14137A	14277	46	54.5	4.3	0.17	0.38	1.57	58	2.28	44	1.73	7000	0.195	0.161
14138A	14277	46	54.5	4.3	0.17	0.38	1.57	58	2.28	46	1.81	7000	0.192	0.161
14139	14277	46	54.5	4.3	0.17	0.38	1.57	58	2.28	44	1.73	7000	0.195	0.161
15000 SERIES														
15100	15243	42.5	47.6	5.7	0.22	0.35	1.71	55	2.17	38	1.50	7000	0.207	0.079
15101	15243	42.5	47.6	5.7	0.22	0.35	1.71	55	2.17	36	1.42	7000	0.210	0.079
15102	15243	42.5	47.6	5.7	0.22	0.35	1.71	55	2.17	36	1.42	7000	0.209	0.079
15103-S	15243	42.5	47.6	5.7	0.22	0.35	1.71	55	2.17	39	1.54	7000	0.201	0.079
15106	15243	42.5	47.6	5.7	0.22	0.35	1.71	55	2.17	37	1.46	7000	0.199	0.079
15112	15243	42.5	47.6	5.7	0.22	0.35	1.71	55	2.17	40	1.57	7000	0.185	0.079
15113	15243	42.5	47.6	5.7	0.22	0.35	1.71	55	2.17	37	1.46	7000	0.188	0.079
15116	15243	42.5	47.6	5.7	0.22	0.35	1.71	55	2.17	41	1.61	7000	0.176	0.079
15117	15243	42.5	47.6	5.7	0.22	0.35	1.71	55	2.17	38	1.50	7000	0.177	0.079
15118	15243	42.5	47.6	5.7	0.22	0.35	1.71	55	2.17	41	1.61	7000	0.173	0.079
15119	15243	42.5	47.6	5.7	0.22	0.35	1.71	55	2.17	41	1.61	7000	0.175	0.079
15120	15243	42.5	47.6	5.7	0.22	0.35	1.71	55	2.17	41	1.61	7000	0.176	0.079
15123	15243	42.5	47.6	5.7	0.22	0.35	1.71	55	2.17	41	1.61	7000	0.176	0.079
15125	15243	42.5	47.6	5.7	0.22	0.35	1.71	55	2.17	42	1.65	7000	0.161	0.079
15126	15243	42.5	47.6	5.7	0.22	0.35	1.71	55	2.17	39	1.54	7000	0.164	0.079
15100	15245	42.5	47.6	5.7	0.22	0.35	1.71	55	2.17	38	1.50	7000	0.207	0.081
15101	15245	42.5	47.6	5.7	0.22	0.35	1.71	55	2.17	36	1.42	7000	0.210	0.081
15102	15245	42.5	47.6	5.7	0.22	0.35	1.71	55	2.17	36	1.42	7000	0.209	0.081

INCH SERIES

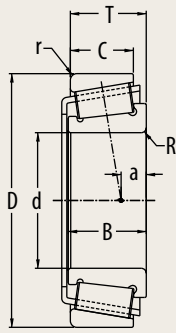

The tables include the most common industry series and sizes in the market. Additional industry series and sizes are available from PEER upon request.

Cone	Cup	d		B		R		D		C		r		T	
		Cone Bore		Cone Width		Max Shaft Radius		Cup Outer Diameter		Cup Width		Max Housing Radius		Total Width	
		mm	inch	mm	inch	mm	inch	mm	inch	mm	inch	mm	inch	mm	inch
15000 SERIES (cont.)															
15103-S	15245	26.162	1.0300	19.939	0.7850	0.8	0.03	62.000	2.4409	14.288	0.5625	1.3	0.05	19.050	0.7500
15106	15245	26.988	1.0625	20.638	0.8125	0.8	0.03	62.000	2.4409	14.288	0.5625	1.3	0.05	19.050	0.7500
15112	15245	28.575	1.1250	20.638	0.8125	3.5	0.14	62.000	2.4409	14.288	0.5625	1.3	0.05	19.050	0.7500
15113	15245	28.575	1.1250	20.638	0.8125	0.8	0.03	62.000	2.4409	14.288	0.5625	1.3	0.05	19.050	0.7500
15116	15245	30.112	1.1855	20.638	0.8125	0.8	0.03	62.000	2.4409	14.288	0.5625	1.3	0.05	19.050	0.7500
15117	15245	29.987	1.1806	20.638	0.8125	1.3	0.05	62.000	2.4409	14.288	0.5625	1.3	0.05	19.050	0.7500
15118	15245	30.213	1.1895	20.638	0.8125	3.5	0.14	62.000	2.4409	14.288	0.5625	1.3	0.05	19.050	0.7500
15119	15245	30.213	1.1895	20.638	0.8125	1.5	0.06	62.000	2.4409	14.288	0.5625	1.3	0.05	19.050	0.7500
15120	15245	30.213	1.1895	20.638	0.8125	0.8	0.03	62.000	2.4409	14.288	0.5625	1.3	0.05	19.050	0.7500
15123	15245	31.750	1.2500	19.050	0.7500	SP	SP	62.000	2.4409	14.288	0.5625	1.3	0.05	18.161	0.7150
15125	15245	31.750	1.2500	20.638	0.8125	3.5	0.14	62.000	2.4409	14.288	0.5625	1.3	0.05	19.050	0.7500
15126	15245	31.750	1.2500	20.638	0.8125	0.8	0.03	62.000	2.4409	14.288	0.5625	1.3	0.05	19.050	0.7500
15100	15250	25.400	1.0000	20.638	0.8125	3.5	0.14	63.500	2.5000	15.875	0.6250	1.3	0.05	20.637	0.8125
15101	15250	25.400	1.0000	20.638	0.8125	0.8	0.03	63.500	2.5000	15.875	0.6250	1.3	0.05	20.637	0.8125
15102	15250	25.400	1.0000	20.638	0.8125	1.5	0.06	63.500	2.5000	15.875	0.6250	1.3	0.05	20.637	0.8125
15103-S	15250	26.162	1.0300	19.939	0.7850	0.8	0.03	63.500	2.5000	15.875	0.6250	1.3	0.05	20.637	0.8125
15106	15250	26.988	1.0625	20.638	0.8125	0.8	0.03	63.500	2.5000	15.875	0.6250	1.3	0.05	20.637	0.8125
15112	15250	28.575	1.1250	20.638	0.8125	3.5	0.14	63.500	2.5000	15.875	0.6250	1.3	0.05	20.637	0.8125
15113	15250	28.575	1.1250	20.638	0.8125	0.8	0.03	63.500	2.5000	15.875	0.6250	1.3	0.05	20.637	0.8125
15116	15250	30.112	1.1855	20.638	0.8125	0.8	0.03	63.500	2.5000	15.875	0.6250	1.3	0.05	20.637	0.8125
15117	15250	29.987	1.1806	20.638	0.8125	1.3	0.05	63.500	2.5000	15.875	0.6250	1.3	0.05	20.637	0.8125
15118	15250	30.213	1.1895	20.638	0.8125	3.5	0.14	63.500	2.5000	15.875	0.6250	1.3	0.05	20.637	0.8125
15119	15250	30.213	1.1895	20.638	0.8125	1.5	0.06	63.500	2.5000	15.875	0.6250	1.3	0.05	20.637	0.8125
15120	15250	30.213	1.1895	20.638	0.8125	0.8	0.03	63.500	2.5000	15.875	0.6250	1.3	0.05	20.637	0.8125
15123	15250	31.750	1.2500	19.050	0.7500	SP	SP	63.500	2.5000	15.875	0.6250	1.3	0.05	18.161	0.7150
15125	15250	31.750	1.2500	20.638	0.8125	3.5	0.14	63.500	2.5000	15.875	0.6250	1.3	0.05	20.637	0.8125
15126	15250	31.750	1.2500	20.638	0.8125	0.8	0.03	63.500	2.5000	15.875	0.6250	1.3	0.05	20.637	0.8125
15100	15250X	25.400	1.0000	20.638	0.8125	3.5	0.14	63.500	2.5000	15.875	0.6250	1.5	0.06	20.637	0.8125
15101	15250X	25.400	1.0000	20.638	0.8125	0.8	0.03	63.500	2.5000	15.875	0.6250	1.5	0.06	20.637	0.8125
15102	15250X	25.400	1.0000	20.638	0.8125	1.5	0.06	63.500	2.5000	15.875	0.6250	1.5	0.06	20.637	0.8125
15103-S	15250X	26.162	1.0300	19.939	0.7850	0.8	0.03	63.500	2.5000	15.875	0.6250	1.5	0.06	20.637	0.8125
15106	15250X	26.988	1.0625	20.638	0.8125	0.8	0.03	63.500	2.5000	15.875	0.6250	1.5	0.06	20.637	0.8125
15112	15250X	28.575	1.1250	20.638	0.8125	3.5	0.14	63.500	2.5000	15.875	0.6250	1.5	0.06	20.637	0.8125
15113	15250X	28.575	1.1250	20.638	0.8125	0.8	0.03	63.500	2.5000	15.875	0.6250	1.5	0.06	20.637	0.8125

$$P = X \cdot Fr + Y \cdot Fa$$

$\frac{Fa}{Fr} \leq e$		$\frac{Fa}{Fr} > e$	
X	Y	X	Y
1	0	0.40	See table

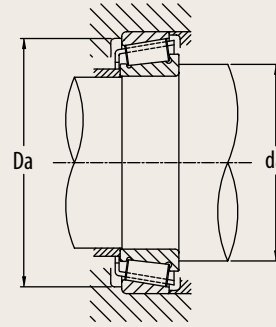

Cone	Cup	Basic Load Rating		a		e	Y Axial Load Factor	Da		da		Reference Speed RPM	Cone Weight Kg	Cup Weight Kg
		Dynamic Cr	Static Cor	Effective Load Center				Housing Bore ID		Shaft OD				
		KN	KN	mm	inch			mm	inch	mm	inch			
15000 SERIES														
15103-S	15245	42.5	47.6	5.7	0.22	0.35	1.71	55	2.17	39	1.54	7000	0.201	0.081
15106	15245	42.5	47.6	5.7	0.22	0.35	1.71	55	2.17	37	1.46	7000	0.199	0.081
15112	15245	42.5	47.6	5.7	0.22	0.35	1.71	55	2.17	40	1.57	7000	0.185	0.081
15113	15245	42.5	47.6	5.7	0.22	0.35	1.71	55	2.17	37	1.46	7000	0.188	0.081
15116	15245	42.5	47.6	5.7	0.22	0.35	1.71	55	2.17	41	1.61	7000	0.176	0.081
15117	15245	42.5	47.6	5.7	0.22	0.35	1.71	55	2.17	38	1.50	7000	0.177	0.081
15118	15245	42.5	47.6	5.7	0.22	0.35	1.71	55	2.17	41	1.61	7000	0.173	0.081
15119	15245	42.5	47.6	5.7	0.22	0.35	1.71	55	2.17	41	1.61	7000	0.175	0.081
15120	15245	42.5	47.6	5.7	0.22	0.35	1.71	55	2.17	41	1.61	7000	0.176	0.081
15123	15245	42.5	47.6	5.7	0.22	0.35	1.71	55	2.17	42	1.65	7000	0.151	0.081
15125	15245	42.5	47.6	5.7	0.22	0.35	1.71	55	2.17	42	1.65	7000	0.161	0.081
15126	15245	42.5	47.6	5.7	0.22	0.35	1.71	55	2.17	39	1.54	7000	0.164	0.081
15100	15250	42.5	47.6	5.7	0.22	0.35	1.71	55	2.17	38	1.50	7000	0.207	0.112
15101	15250	42.5	47.6	5.7	0.22	0.35	1.71	55	2.17	36	1.42	7000	0.210	0.112
15102	15250	42.5	47.6	5.7	0.22	0.35	1.71	55	2.17	36	1.42	7000	0.209	0.112
15103-S	15250	42.5	47.6	5.7	0.22	0.35	1.71	55	2.17	39	1.54	7000	0.201	0.112
15106	15250	42.5	47.6	5.7	0.22	0.35	1.71	55	2.17	37	1.46	7000	0.199	0.112
15112	15250	42.5	47.6	5.7	0.22	0.35	1.71	55	2.17	40	1.57	7000	0.185	0.112
15113	15250	42.5	47.6	5.7	0.22	0.35	1.71	55	2.17	37	1.46	7000	0.188	0.112
15116	15250	42.5	47.6	5.7	0.22	0.35	1.71	55	2.17	41	1.61	7000	0.176	0.112
15117	15250	42.5	47.6	5.7	0.22	0.35	1.71	55	2.17	38	1.50	7000	0.177	0.112
15118	15250	42.5	47.6	5.7	0.22	0.35	1.71	55	2.17	41	1.61	7000	0.173	0.112
15119	15250	42.5	47.6	5.7	0.22	0.35	1.71	55	2.17	41	1.61	7000	0.175	0.112
15120	15250	42.5	47.6	5.7	0.22	0.35	1.71	55	2.17	41	1.61	7000	0.176	0.112
15123	15250	42.5	47.6	5.7	0.22	0.35	1.71	55	2.17	42	1.65	7000	0.151	0.112
15125	15250	42.5	47.6	5.7	0.22	0.35	1.71	55	2.17	42	1.65	7000	0.161	0.112
15126	15250	42.5	47.6	5.7	0.22	0.35	1.71	55	2.17	39	1.54	7000	0.164	0.112
15100	15250X	42.5	47.6	5.7	0.22	0.35	1.71	55	2.17	38	1.50	7000	0.207	0.112
15101	15250X	42.5	47.6	5.7	0.22	0.35	1.71	55	2.17	36	1.42	7000	0.210	0.112
15102	15250X	42.5	47.6	5.7	0.22	0.35	1.71	55	2.17	36	1.42	7000	0.209	0.112
15103-S	15250X	42.5	47.6	5.7	0.22	0.35	1.71	55	2.17	39	1.54	7000	0.201	0.112
15106	15250X	42.5	47.6	5.7	0.22	0.35	1.71	55	2.17	37	1.46	7000	0.199	0.112
15112	15250X	42.5	47.6	5.7	0.22	0.35	1.71	55	2.17	40	1.57	7000	0.185	0.112
15113	15250X	42.5	47.6	5.7	0.22	0.35	1.71	55	2.17	37	1.46	7000	0.188	0.112

INCH SERIES

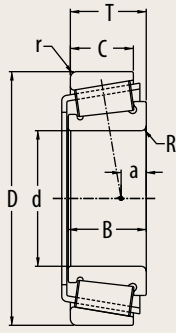

The tables include the most common industry series and sizes in the market. Additional industry series and sizes are available from PEER upon request.

Cone	Cup	d		B		R		D		C		r		T	
		Cone Bore		Cone Width		Max Shaft Radius		Cup Outer Diameter		Cup Width		Max Housing Radius		Total Width	
		mm	inch	mm	inch	mm	inch	mm	inch	mm	inch	mm	inch	mm	inch
15000 SERIES (cont.)															
15116	15250X	30.112	1.1855	20.638	0.8125	0.8	0.03	63.500	2.5000	15.875	0.6250	1.5	0.06	20.637	0.8125
15117	15250X	29.987	1.1806	20.638	0.8125	1.3	0.05	63.500	2.5000	15.875	0.6250	1.5	0.06	20.637	0.8125
15118	15250X	30.213	1.1895	20.638	0.8125	3.5	0.14	63.500	2.5000	15.875	0.6250	1.5	0.06	20.637	0.8125
15119	15250X	30.213	1.1895	20.638	0.8125	1.5	0.06	63.500	2.5000	15.875	0.6250	1.5	0.06	20.637	0.8125
15120	15250X	30.213	1.1895	20.638	0.8125	0.8	0.03	63.500	2.5000	15.875	0.6250	1.5	0.06	20.637	0.8125
15123	15250X	31.750	1.2500	19.050	0.7500	SP	SP	63.500	2.5000	15.875	0.6250	1.5	0.06	18.161	0.7150
15125	15250X	31.750	1.2500	20.638	0.8125	3.5	0.14	63.500	2.5000	15.875	0.6250	1.5	0.06	20.637	0.8125
15126	15250X	31.750	1.2500	20.638	0.8125	0.8	0.03	63.500	2.5000	15.875	0.6250	1.5	0.06	20.637	0.8125
15500 SERIES															
15578	15520	25.400	1.0000	17.462	0.6875	1.3	0.05	57.150	2.2500	13.495	0.5313	1.5	0.06	17.462	0.6875
15580	15520	26.988	1.0625	17.462	0.6875	3.5	0.14	57.150	2.2500	13.495	0.5313	1.5	0.06	17.462	0.6875
15590	15520	28.575	1.1250	17.462	0.6875	3.5	0.14	57.150	2.2500	13.495	0.5313	1.5	0.06	17.462	0.6875
16000 SERIES															
16150	16282	38.100	1.5000	20.638	0.8125	3.5	0.14	72.000	2.8346	14.237	0.5605	1.5	0.06	19.000	0.7480
16150	16284	38.100	1.5000	20.638	0.8125	3.5	0.14	72.238	2.8440	15.875	0.6250	1.3	0.05	20.638	0.8125
17000 SERIES															
17118	17244	29.987	1.1806	16.566	0.6522	1.5	0.06	62.000	2.4409	14.288	0.5625	1.5	0.06	16.002	0.6300
17500 SERIES															
17580	17520	15.875	0.6250	16.670	0.6563	1.5	0.06	42.862	1.6875	13.495	0.5313	1.5	0.06	16.670	0.6563
17800 SERIES															
17887	17831	45.230	1.7807	20.638	0.8125	2.0	0.08	79.985	3.1490	15.080	0.5937	1.3	0.05	19.842	0.7812
18500 SERIES															
18590	18520	41.275	1.6250	17.462	0.6875	3.5	0.14	73.025	2.8750	12.700	0.5000	1.5	0.06	16.667	0.6562
18600 SERIES															
18685	18620	44.450	1.7500	17.462	0.6875	2.8	0.11	79.375	3.1250	13.495	0.5313	1.5	0.06	17.462	0.6875
18690	18620	46.038	1.8125	17.462	0.6875	2.8	0.11	79.375	3.1250	13.495	0.5313	1.5	0.06	17.462	0.6875
18700 SERIES															
18780	18720	46.038	1.8125	17.462	0.6875	2.3	0.09	85.000	3.3465	13.495	0.5313	1.5	0.06	17.462	0.6875
18790	18720	50.800	2.0000	17.462	0.6875	3.5	0.14	85.000	3.3465	13.495	0.5313	1.5	0.06	17.462	0.6875
19000 SERIES															
19138	19268	34.976	1.3770	16.520	0.6504	1.5	0.06	68.262	2.6875	11.908	0.4688	1.5	0.06	15.875	0.6250
19150	19268	38.100	1.5000	16.520	0.6504	1.5	0.06	68.262	2.6875	11.908	0.4688	1.5	0.06	15.875	0.6250
19138	19268x	34.976	1.3770	16.520	0.6504	1.5	0.06	68.275	2.6880	16.032	0.6312	1.5	0.06	20.000	0.7874
19150	19268x	38.100	1.5000	16.520	0.6504	1.5	0.06	68.275	2.6880	16.032	0.6312	1.5	0.06	20.000	0.7874

$$P = X \cdot Fr + Y \cdot Fa$$

$\frac{Fa}{Fr} \leq e$		$\frac{Fa}{Fr} > e$	
X	Y	X	Y
1	0	0.40	See table

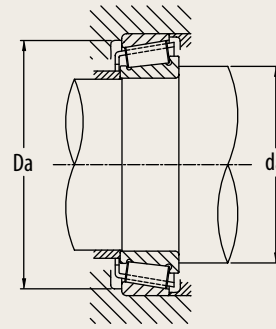

Cone	Cup	Basic Load Rating		a		e	Y Axial Load Factor	Da		da		Reference Speed RPM	Cone Weight Kg	Cup Weight Kg
		Dynamic Cr	Static Cor	Effective Load Center				Housing Bore ID		Shaft OD				
		KN	KN	mm	inch			mm	inch	mm	inch			
15000 SERIES														
15116	15250X	42.5	47.6	5.7	0.22	0.35	1.71	55	2.17	41	1.61	7000	0.176	0.112
15117	15250X	42.5	47.6	5.7	0.22	0.35	1.71	55	2.17	38	1.50	7000	0.177	0.112
15118	15250X	42.5	47.6	5.7	0.22	0.35	1.71	55	2.17	41	1.61	7000	0.173	0.112
15119	15250X	42.5	47.6	5.7	0.22	0.35	1.71	55	2.17	41	1.61	7000	0.175	0.112
15120	15250X	42.5	47.6	5.7	0.22	0.35	1.71	55	2.17	41	1.61	7000	0.176	0.112
15123	15250X	42.5	47.6	5.7	0.22	0.35	1.71	55	2.17	42	1.65	7000	0.151	0.112
15125	15250X	42.5	47.6	5.7	0.22	0.35	1.71	55	2.17	42	1.65	7000	0.161	0.112
15126	15250X	42.5	47.6	5.7	0.22	0.35	1.71	55	2.17	39	1.54	7000	0.164	0.112
15500 SERIES														
15578	15520	38.7	44.1	4.8	0.19	0.35	1.73	50	1.97	35	1.38	8000	0.149	0.069
15580	15520	38.7	44.1	4.8	0.19	0.35	1.73	50	1.97	38	1.50	8000	0.137	0.069
15590	15520	38.7	44.1	4.8	0.19	0.35	1.73	50	1.97	38	1.50	8000	0.128	0.069
16000 SERIES														
16150	16282	47.4	57.4	4.0	0.16	0.40	1.49	63	2.48	49	1.93	6500	0.203	0.122
16150	16284	47.4	57.4	4.0	0.16	0.40	1.49	63	2.48	49	1.93	6500	0.203	0.125
17000 SERIES														
17118	17244	35	36.6	3.7	0.15	0.38	1.57	54	2.13	38	1.50	10000	0.130	0.090
17500 SERIES														
17580	17520	28.4	26.9	5.8	0.23	0.33	1.81	36	1.42	23	0.91	11000	0.076	0.048
17800 SERIES														
17887	17831	51.4	64.4	3.5	0.14	0.37	1.64	72	2.83	54	2.13	5500	0.282	0.135
18500 SERIES														
18590	18520	43	51.2	2.8	0.11	0.35	1.71	66	2.60	52	2.05	5500	0.193	0.085
18600 SERIES														
18685	18620	44.2	54.3	2.0	0.08	0.37	1.60	71	2.80	55	2.17	5500	0.223	0.124
18690	18620	44.2	54.3	2.0	0.08	0.37	1.60	71	2.80	56	2.20	5500	0.207	0.124
18700 SERIES														
18780	18720	48.5	63	0.5	0.02	0.41	1.48	77	3.03	58	2.28	5000	0.290	0.135
18790	18720	48.5	63	0.5	0.02	0.41	1.48	77	3.03	61	2.40	5000	0.238	0.135
19000 SERIES														
19138	19268	44.2	51	1.4	0.06	0.44	1.35	61	2.40	44	1.73	6000	0.186	0.073
19150	19268	44.2	51	1.4	0.06	0.44	1.35	61	2.40	46	1.81	6000	0.163	0.073
19138	19268x	44.2	51	1.4	0.06	0.44	1.35	59	2.32	44	1.73	6000	0.186	0.113
19150	19268x	44.2	51	1.4	0.06	0.44	1.35	59	2.32	46	1.81	6000	0.163	0.113

INCH SERIES

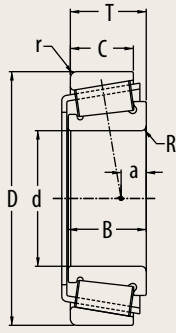

The tables include the most common industry series and sizes in the market. Additional industry series and sizes are available from PEER upon request.

Cone	Cup	d		B		R		D		C		r		T	
		Cone Bore		Cone Width		Max Shaft Radius		Cup Outer Diameter		Cup Width		Max Housing Radius		Total Width	
		mm	inch	mm	inch	mm	inch	mm	inch	mm	inch	mm	inch	mm	inch
19000 SERIES (cont.)															
19138	19281	34.976	1.3770	16.520	0.6504	1.5	0.06	71.438	2.8125	11.908	0.4688	1.0	0.04	15.875	0.6250
19150	19281	38.100	1.5000	16.520	0.6504	1.5	0.06	71.438	2.8125	11.908	0.4688	1.0	0.04	15.875	0.6250
21000 SERIES															
21075	21212	19.050	0.7500	21.839	0.8598	1.5	0.06	53.975	2.1250	15.875	0.6250	2.3	0.09	22.225	0.8750
L21500 SERIES															
L21549	L21511	15.875	0.6250	10.998	0.4330	1.3	0.05	34.989	1.3775	8.712	0.3430	1.3	0.05	10.998	0.4330
23000 SERIES															
23092	23256	23.812	0.9375	21.463	0.8450	1.5	0.06	65.088	2.5625	15.875	0.6250	1.5	0.06	22.225	0.8750
23100	23256	25.400	1.0000	21.463	0.8450	1.5	0.06	65.088	2.5625	15.875	0.6250	1.5	0.06	22.225	0.8750
24700 SERIES															
24780	24720	41.275	1.6250	23.020	0.9063	3.5	0.14	76.200	3.0000	17.462	0.6875	0.8	0.03	22.225	0.8750
24780	24721	41.275	1.6250	23.020	0.9063	3.5	0.14	76.200	3.0000	20.638	0.8125	2.3	0.09	25.400	1.0000
24780	24722	41.275	1.6250	23.020	0.9063	3.5	0.14	76.200	3.0000	17.462	0.6875	3.3	0.13	22.225	0.8750
25500 SERIES															
25577	25519	42.875	1.6880	25.400	1.0000	3.5	0.14	82.550	3.2500	19.050	0.7500	2.0	0.08	23.812	0.9375
25578	25519	42.862	1.6875	25.400	1.0000	2.3	0.09	82.550	3.2500	19.050	0.7500	2.0	0.08	23.812	0.9375
25580	25519	44.450	1.7500	25.400	1.0000	3.5	0.14	82.550	3.2500	19.050	0.7500	2.0	0.08	23.812	0.9375
25584	25519	44.983	1.7710	25.400	1.0000	1.5	0.06	82.550	3.2500	19.050	0.7500	2.0	0.08	23.812	0.9375
25590	25519	45.618	1.7960	25.400	1.0000	3.5	0.14	82.550	3.2500	19.050	0.7500	2.0	0.08	23.812	0.9375
25577	25520	42.875	1.6880	25.400	1.0000	3.5	0.14	82.931	3.2650	19.050	0.7500	0.8	0.03	23.812	0.9375
25578	25520	42.862	1.6875	25.400	1.0000	2.3	0.09	82.931	3.2650	19.050	0.7500	0.8	0.03	23.812	0.9375
25580	25520	44.450	1.7500	25.400	1.0000	3.5	0.14	82.931	3.2650	19.050	0.7500	0.8	0.03	23.812	0.9375
25584	25520	44.983	1.7710	25.400	1.0000	1.5	0.06	82.931	3.2650	19.050	0.7500	0.8	0.03	23.812	0.9375
25590	25520	45.618	1.7960	25.400	1.0000	3.5	0.14	82.931	3.2650	19.050	0.7500	0.8	0.03	23.812	0.9375
25577	25521	42.875	1.6880	25.400	1.0000	3.5	0.14	83.058	3.2700	19.050	0.7500	3.3	0.13	23.812	0.9375
25578	25521	42.862	1.6875	25.400	1.0000	2.3	0.09	83.058	3.2700	19.050	0.7500	3.3	0.13	23.812	0.9375
25580	25521	44.450	1.7500	25.400	1.0000	3.5	0.14	83.058	3.2700	19.050	0.7500	3.3	0.13	23.812	0.9375
25584	25521	44.983	1.7710	25.400	1.0000	1.5	0.06	83.058	3.2700	19.050	0.7500	3.3	0.13	23.812	0.9375
25590	25521	45.618	1.7960	25.400	1.0000	3.5	0.14	83.058	3.2700	19.050	0.7500	3.3	0.13	23.812	0.9375
25577	25522	42.875	1.6880	25.400	1.0000	3.5	0.14	83.058	3.2700	19.114	0.7525	2.0	0.08	23.876	0.9400
25578	25522	42.862	1.6875	25.400	1.0000	2.3	0.09	83.058	3.2700	19.114	0.7525	2.0	0.08	23.876	0.9400
25580	25522	44.450	1.7500	25.400	1.0000	3.5	0.14	83.058	3.2700	19.114	0.7525	2.0	0.08	23.876	0.9400
25584	25522	44.983	1.7710	25.400	1.0000	1.5	0.06	83.058	3.2700	19.114	0.7525	2.0	0.08	23.876	0.9400
25590	25522	45.618	1.7960	25.400	1.0000	3.5	0.14	83.058	3.2700	19.114	0.7525	2.0	0.08	23.876	0.9400

$$P = X \cdot Fr + Y \cdot Fa$$

$\frac{Fa}{Fr} \leq e$		$\frac{Fa}{Fr} > e$	
X	Y	X	Y
1	0	0.40	See table

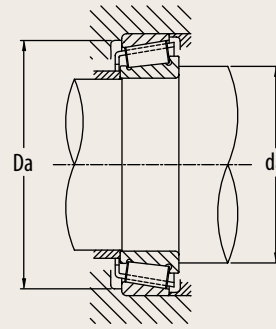

Cone	Cup	Basic Load Rating		a		e	Y Axial Load Factor	Da		da		Reference Speed RPM	Cone Weight Kg	Cup Weight Kg
		Dynamic Cr	Static Cor	Effective Load Center				Housing Bore ID		Shaft OD				
		KN	KN	mm	inch			mm	inch	mm	inch			
19000 SERIES														
19138	19281	44.2	51.0	1.4	0.06	0.44	1.35	63	2.48	44	1.73	6000	0.186	0.106
19150	19281	44.2	51.0	1.4	0.06	0.44	1.35	63	2.48	46	1.81	6000	0.163	0.106
21000 SERIES														
21075	21212	40	38.7	5.7	0.22	0.59	1.02	43	1.69	29	1.14	12000	0.153	0.095
L21500 SERIES														
L21549	L21511	12.7	12	3.4	0.13	0.32	1.88	29	1.14	21	0.83	12000	0.030	0.018
23000 SERIES														
23092	23256	45.1	48	2.1	0.08	0.73	0.82	53	2.09	36	1.42	9000	0.226	0.141
23100	23256	45.1	48	2.1	0.08	0.73	0.82	53	2.09	37	1.46	9000	0.215	0.141
24700 SERIES														
24780	24720	62.9	77.8	4.8	0.19	0.39	1.53	68	2.68	52	2.05	6000	0.276	0.149
24780	24721	62.9	77.8	4.8	0.19	0.39	1.53	65	2.56	52	2.05	6000	0.276	0.187
24780	24722	62.9	77.8	4.8	0.19	0.39	1.53	65	2.56	52	2.05	6000	0.276	0.142
25500 SERIES														
25577	25519	74.8	95.7	6.4	0.25	0.33	1.79	73	2.87	56	2.20	5500	0.374	0.192
25578	25519	74.8	95.7	6.4	0.25	0.33	1.79	73	2.87	54	2.13	5500	0.376	0.192
25580	25519	74.8	95.7	6.4	0.25	0.33	1.79	73	2.87	56	2.20	5500	0.352	0.192
25584	25519	74.8	95.7	6.4	0.25	0.33	1.79	73	2.87	55	2.17	5500	0.348	0.192
25590	25519	74.8	95.7	6.4	0.25	0.33	1.79	73	2.87	57	2.24	5500	0.336	0.192
25577	25520	74.8	95.7	6.4	0.25	0.33	1.79	74	2.91	56	2.20	5500	0.374	0.202
25578	25520	74.8	95.7	6.4	0.25	0.33	1.79	74	2.91	54	2.13	5500	0.376	0.202
25580	25520	74.8	95.7	6.4	0.25	0.33	1.79	74	2.91	56	2.20	5500	0.352	0.202
25584	25520	74.8	95.7	6.4	0.25	0.33	1.79	74	2.91	55	2.17	5500	0.348	0.202
25590	25520	74.8	95.7	6.4	0.25	0.33	1.79	74	2.91	57	2.24	5500	0.336	0.202
25577	25521	74.8	95.7	6.4	0.25	0.33	1.79	72	2.83	56	2.20	5500	0.374	0.196
25578	25521	74.8	95.7	6.4	0.25	0.33	1.79	72	2.83	54	2.13	5500	0.376	0.196
25580	25521	74.8	95.7	6.4	0.25	0.33	1.79	72	2.83	56	2.20	5500	0.352	0.196
25584	25521	74.8	95.7	6.4	0.25	0.33	1.79	72	2.83	55	2.17	5500	0.348	0.196
25590	25521	74.8	95.7	6.4	0.25	0.33	1.79	72	2.83	57	2.24	5500	0.336	0.196
25577	25522	74.8	95.7	6.4	0.25	0.33	1.79	73	2.87	56	2.20	5500	0.374	0.202
25578	25522	74.8	95.7	6.4	0.25	0.33	1.79	73	2.87	54	2.13	5500	0.376	0.202
25580	25522	74.8	95.7	6.4	0.25	0.33	1.79	73	2.87	56	2.20	5500	0.352	0.202
25584	25522	74.8	95.7	6.4	0.25	0.33	1.79	73	2.87	55	2.17	5500	0.348	0.202
25590	25522	74.8	95.7	6.4	0.25	0.33	1.79	73	2.87	57	2.24	5500	0.336	0.202

INCH SERIES

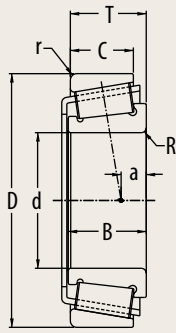

The tables include the most common industry series and sizes in the market. Additional industry series and sizes are available from PEER upon request.

Cone	Cup	d		B		R		D		C		r		T	
		Cone Bore		Cone Width		Max Shaft Radius		Cup Outer Diameter		Cup Width		Max Housing Radius		Total Width	
		mm	inch	mm	inch	mm	inch	mm	inch	mm	inch	mm	inch	mm	inch
25500 SERIES (cont.)															
25577	25523	42.875	1.6880	25.400	1.0000	3.5	0.14	82.931	3.2650	22.225	0.8750	2.3	0.09	26.988	1.0625
25578	25523	42.862	1.6875	25.400	1.0000	2.3	0.09	82.931	3.2650	22.225	0.8750	2.3	0.09	26.988	1.0625
25580	25523	44.450	1.7500	25.400	1.0000	3.5	0.14	82.931	3.2650	22.225	0.8750	2.3	0.09	26.988	1.0625
25584	25523	44.983	1.7710	25.400	1.0000	1.5	0.06	82.931	3.2650	22.225	0.8750	2.3	0.09	26.988	1.0625
25590	25521	45.618	1.7960	25.400	1.0000	3.5	0.14	82.931	3.2650	22.225	0.8750	2.3	0.09	26.988	1.0625
25577	25522	42.875	1.6880	25.400	1.0000	3.5	0.14	85.000	3.3465	19.050	0.7500	2.3	0.09	23.812	0.9375
25578	25522	42.862	1.6875	25.400	1.0000	2.3	0.09	85.000	3.3465	19.050	0.7500	2.3	0.09	23.812	0.9375
25580	25522	44.450	1.7500	25.400	1.0000	3.5	0.14	85.000	3.3465	19.050	0.7500	2.3	0.09	23.812	0.9375
25584	25522	44.983	1.7710	25.400	1.0000	1.5	0.06	85.000	3.3465	19.050	0.7500	2.3	0.09	23.812	0.9375
25590	25522	45.618	1.7960	25.400	1.0000	3.5	0.14	85.000	3.3465	19.050	0.7500	2.3	0.09	23.812	0.9375
25800 SERIES															
25877	25820	34.925	1.3750	24.608	0.9688	1.5	0.06	73.025	2.8750	19.050	0.7500	2.3	0.09	23.812	0.9375
25878	25820	34.925	1.3750	24.608	0.9688	3.5	0.14	73.025	2.8750	19.050	0.7500	2.3	0.09	23.812	0.9375
25880	25820	36.487	1.4365	24.608	0.9688	1.5	0.06	73.025	2.8750	19.050	0.7500	2.3	0.09	23.812	0.9375
25877	25821	34.925	1.3750	24.608	0.9688	1.5	0.06	73.025	2.8750	19.050	0.7500	0.8	0.03	23.812	0.9375
25878	25821	34.925	1.3750	24.608	0.9688	3.5	0.14	73.025	2.8750	19.050	0.7500	0.8	0.03	23.812	0.9375
25880	25821	36.487	1.4365	24.608	0.9688	1.5	0.06	73.025	2.8750	19.050	0.7500	0.8	0.03	23.812	0.9375
26000 SERIES															
26118	26283	29.987	1.1806	18.923	0.7450	1.5	0.06	72.000	2.8346	15.875	0.6250	1.5	0.06	19.000	0.7480
26800 SERIES															
26878	26820	38.100	1.5000	25.400	1.0000	0.8	0.03	80.167	3.1562	20.638	0.8125	3.3	0.13	25.400	1.0000
26881	26820	39.688	1.5625	25.400	1.0000	3.5	0.14	80.167	3.1562	20.638	0.8125	3.3	0.13	25.400	1.0000
26882	26820	41.275	1.6250	25.400	1.0000	3.5	0.14	80.167	3.1562	20.638	0.8125	3.3	0.13	25.400	1.0000
26883	26820	35.000	1.3780	25.400	1.0000	0.8	0.03	80.167	3.1562	20.638	0.8125	3.3	0.13	25.400	1.0000
26884	26820	42.875	1.6880	25.400	1.0000	3.5	0.14	80.167	3.1562	20.638	0.8125	3.3	0.13	25.400	1.0000
26883	26820	42.875	1.6880	25.400	1.0000	1.5	0.06	80.167	3.1562	20.638	0.8125	3.3	0.13	25.400	1.0000
26884	26820	38.100	1.5000	25.400	1.0000	0.8	0.03	80.167	3.1562	24.608	0.9688	3.3	0.13	29.370	1.1563
26886	26820	39.688	1.5625	25.400	1.0000	3.5	0.14	80.167	3.1562	24.608	0.9688	3.3	0.13	29.370	1.1563
26878	26821	41.275	1.6250	25.400	1.0000	3.5	0.14	80.167	3.1562	24.608	0.9688	3.3	0.13	29.370	1.1563
26881	26821	35.000	1.3780	25.400	1.0000	0.8	0.03	80.167	3.1562	24.608	0.9688	3.3	0.13	29.370	1.1563
26882	26821	42.875	1.6880	25.400	1.0000	3.5	0.14	80.167	3.1562	24.608	0.9688	3.3	0.13	29.370	1.1563
26883	26821	42.875	1.6880	25.400	1.0000	1.5	0.06	80.167	3.1562	24.608	0.9688	3.3	0.13	29.370	1.1563
26884	26821	38.100	1.5000	25.400	1.0000	0.8	0.03	79.375	3.1250	19.050	0.7500	0.8	0.03	23.812	0.9375
26886	26821	39.688	1.5625	25.400	1.0000	3.5	0.14	79.375	3.1250	19.050	0.7500	0.8	0.03	23.812	0.9375

$$P = X \cdot Fr + Y \cdot Fa$$

$\frac{Fa}{Fr} \leq e$		$\frac{Fa}{Fr} > e$	
X	Y	X	Y
1	0	0.40	See table

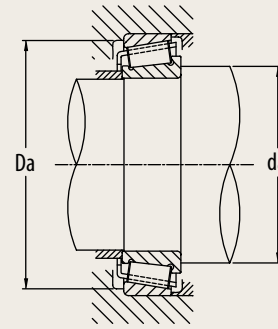

Cone	Cup	Basic Load Rating		a		e	Y Axial Load Factor	Da		da		Reference Speed RPM	Cone Weight Kg	Cup Weight Kg
		Dynamic Cr	Static Cor	Effective Load Center				Housing Bore ID	Shaft OD					
		KN	KN	mm	inch			mm	inch	mm	inch			
25500 SERIES														
25577	25523	74.8	95.7	6.4	0.25	0.33	1.79	72	2.83	56	2.20	5500	0.374	0.245
25578	25523	74.8	95.7	6.4	0.25	0.33	1.79	72	2.83	54	2.13	5500	0.376	0.245
25580	25523	74.8	95.7	6.4	0.25	0.33	1.79	72	2.83	56	2.20	5500	0.352	0.245
25584	25523	74.8	95.7	6.4	0.25	0.33	1.79	72	2.83	55	2.17	5500	0.348	0.245
25590	25521	74.8	95.7	6.4	0.25	0.33	1.79	72	2.83	57	2.24	5500	0.336	0.245
25577	25522	74.8	95.7	6.4	0.25	0.33	1.79	74	2.91	56	2.20	5500	0.374	0.238
25578	25522	74.8	95.7	6.4	0.25	0.33	1.79	74	2.91	54	2.13	5500	0.376	0.238
25580	25522	74.8	95.7	6.4	0.25	0.33	1.79	74	2.91	56	2.20	5500	0.352	0.238
25584	25522	74.8	95.7	6.4	0.25	0.33	1.79	74	2.91	55	2.17	5500	0.348	0.238
25590	25522	74.8	95.7	6.4	0.25	0.33	1.79	74	2.91	57	2.24	5500	0.336	0.238
25800 SERIES														
25877	25820	69	82.6	8.1	0.32	0.29	2.07	63	2.48	45	1.77	6500	0.302	0.162
25878	25820	69	82.6	8.1	0.32	0.29	2.07	63	2.48	47	1.85	6500	0.299	0.162
25880	25820	69	82.6	8.1	0.32	0.29	2.07	63	2.48	45	1.77	6500	0.285	0.162
25877	25821	69	82.6	8.1	0.32	0.29	2.07	65	2.56	45	1.77	6500	0.302	0.166
25878	25821	69	82.6	8.1	0.32	0.29	2.07	65	2.56	47	1.85	6500	0.299	0.166
25880	25821	69	82.6	8.1	0.32	0.29	2.07	65	2.56	45	1.77	6500	0.285	0.166
26000 SERIES														
26118	26283	49.1	52.3	4.2	0.17	0.36	1.67	62	2.44	40	1.57	7000	0.224	0.161
26800 SERIES														
26878	26820	74.7	94.4	7.4	0.29	0.32	1.88	68	2.68	49	1.93	6000	0.382	0.214
26881	26820	74.7	94.4	7.4	0.29	0.32	1.88	68	2.68	52	2.05	6000	0.359	0.214
26882	26820	74.7	94.4	7.4	0.29	0.32	1.88	68	2.68	53	2.09	6000	0.339	0.214
26883	26820	74.7	94.4	7.4	0.29	0.32	1.88	68	2.68	47	1.85	6000	0.417	0.214
26884	26820	74.7	94.4	7.4	0.29	0.32	1.88	68	2.68	54	2.13	6000	0.318	0.214
26883	26820	74.7	94.4	7.4	0.29	0.32	1.88	68	2.68	52	2.05	6000	0.321	0.214
26884	26820	74.7	94.4	7.4	0.29	0.32	1.88	68	2.68	49	1.93	6000	0.382	0.274
26886	26820	74.7	94.4	7.4	0.29	0.32	1.88	68	2.68	52	2.05	6000	0.359	0.274
26878	26821	74.7	94.4	7.4	0.29	0.32	1.88	68	2.68	53	2.09	6000	0.339	0.274
26881	26821	74.7	94.4	7.4	0.29	0.32	1.88	68	2.68	47	1.85	6000	0.417	0.274
26882	26821	74.7	94.4	7.4	0.29	0.32	1.88	68	2.68	54	2.13	6000	0.318	0.274
26883	26821	74.7	94.4	7.4	0.29	0.32	1.88	68	2.68	52	2.05	6000	0.321	0.274
26884	26821	74.7	94.4	7.4	0.29	0.32	1.88	70	2.76	49	1.93	6000	0.382	0.185
26886	26821	74.7	94.4	7.4	0.29	0.32	1.88	70	2.76	52	2.05	6000	0.359	0.185

INCH SERIES

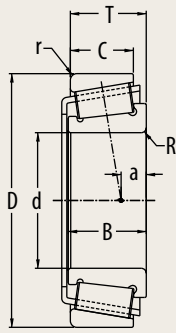

The tables include the most common industry series and sizes in the market. Additional industry series and sizes are available from PEER upon request.

Cone	Cup	d		B		R		D		C		r		T	
		Cone Bore		Cone Width		Max Shaft Radius		Cup Outer Diameter		Cup Width		Max Housing Radius		Total Width	
		mm	inch	mm	inch	mm	inch	mm	inch	mm	inch	mm	inch	mm	inch
26800 SERIES (cont.)															
26878	26822	41.275	1.6250	25.400	1.0000	3.5	0.14	79.375	3.1250	19.050	0.7500	0.8	0.03	23.812	0.9375
26883	26822	35.000	1.3780	25.400	1.0000	0.8	0.03	79.375	3.1250	19.050	0.7500	0.8	0.03	23.812	0.9375
26884	26822	42.875	1.6880	25.400	1.0000	3.5	0.14	79.375	3.1250	19.050	0.7500	0.8	0.03	23.812	0.9375
26886	26822	42.875	1.6880	25.400	1.0000	1.5	0.06	79.375	3.1250	19.050	0.7500	0.8	0.03	23.812	0.9375
26878	26823	38.100	1.5000	25.400	1.0000	0.8	0.03	76.200	3.0000	20.638	0.8125	1.5	0.06	25.400	1.0000
26881	26823	39.688	1.5625	25.400	1.0000	3.5	0.14	76.200	3.0000	20.638	0.8125	1.5	0.06	25.400	1.0000
26882	26823	41.275	1.6250	25.400	1.0000	3.5	0.14	76.200	3.0000	20.638	0.8125	1.5	0.06	25.400	1.0000
26883	26823	35.000	1.3780	25.400	1.0000	0.8	0.03	76.200	3.0000	20.638	0.8125	1.5	0.06	25.400	1.0000
26884	26823	42.875	1.6880	25.400	1.0000	3.5	0.14	76.200	3.0000	20.638	0.8125	1.5	0.06	25.400	1.0000
26886	26823	42.875	1.6880	25.400	1.0000	1.5	0.06	76.200	3.0000	20.638	0.8125	1.5	0.06	25.400	1.0000
26878	26830	38.100	1.5000	25.400	1.0000	0.8	0.03	80.167	3.1562	20.638	0.8125	0.8	0.03	25.400	1.0000
26881	26830	39.688	1.5625	25.400	1.0000	3.5	0.14	80.167	3.1562	20.638	0.8125	0.8	0.03	25.400	1.0000
26882	26830	41.275	1.6250	25.400	1.0000	3.5	0.14	80.167	3.1562	20.638	0.8125	0.8	0.03	25.400	1.0000
26883	26830	35.000	1.3780	25.400	1.0000	0.8	0.03	80.167	3.1562	20.638	0.8125	0.8	0.03	25.400	1.0000
26884	26830	42.875	1.6880	25.400	1.0000	3.5	0.14	80.167	3.1562	20.638	0.8125	0.8	0.03	25.400	1.0000
26886	26830	42.875	1.6880	25.400	1.0000	1.5	0.06	80.167	3.1562	20.638	0.8125	0.8	0.03	25.400	1.0000
27600 SERIES															
27687	27620	82.550	3.2500	25.400	1.0000	3.5	0.14	125.412	4.9375	19.845	0.7813	1.5	0.06	25.400	1.0000
27689	27620	83.345	3.2813	25.400	1.0000	0.8	0.03	125.412	4.9375	19.845	0.7813	1.5	0.06	25.400	1.0000
27800 SERIES															
27881	27820	38.100	1.5000	23.698	0.9330	3.5	0.14	80.035	3.1510	18.512	0.7288	1.5	0.06	24.608	0.9688
28000 SERIES															
28150	28300	38.100	1.5000	20.940	0.8244	1.5	0.06	76.200	3.0000	15.507	0.6105	1.3	0.05	20.637	0.8125
28500 SERIES															
28579	28520	49.987	1.9680	25.400	1.0000	2.3	0.09	89.980	3.5425	19.987	0.7869	2.3	0.09	24.750	0.9744
28580	28520	50.800	2.0000	25.400	1.0000	3.5	0.14	89.980	3.5425	19.987	0.7869	2.3	0.09	24.750	0.9744
28584	28520	52.388	2.0625	25.400	1.0000	3.5	0.14	89.980	3.5425	19.987	0.7869	2.3	0.09	24.750	0.9744
28579	28521	49.987	1.9680	25.400	1.0000	2.3	0.09	92.075	3.6250	19.845	0.7813	0.8	0.03	24.607	0.9688
28580	28521	50.800	2.0000	25.400	1.0000	3.5	0.14	92.075	3.6250	19.845	0.7813	0.8	0.03	24.607	0.9688
28584	28521	52.388	2.0625	25.400	1.0000	3.5	0.14	92.075	3.6250	19.845	0.7813	0.8	0.03	24.607	0.9688
28600 SERIES															
28678	28621	50.800	2.0000	24.608	0.9688	3.5	0.14	96.838	3.8125	19.446	0.7656	0.8	0.03	24.608	0.9688
28682	28621	57.150	2.2500	24.608	0.9688	3.5	0.14	96.838	3.8125	19.446	0.7656	0.8	0.03	24.608	0.9688

$$P = X \cdot F_r + Y \cdot F_a$$

$\frac{F_a}{F_r} \leq e$		$\frac{F_a}{F_r} > e$	
X	Y	X	Y
1	0	0.40	See table

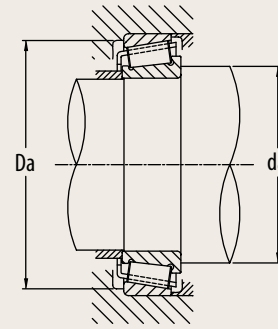

Cone	Cup	Basic Load Rating		a		e	Y Axial Load Factor	Da		da		Reference Speed RPM	Cone Weight Kg	Cup Weight Kg
		Dynamic Cr	Static Cor	Effective Load Center				Housing Bore ID		Shaft OD				
		KN	KN	mm	inch			mm	inch	mm	inch			
26800 SERIES														
26878	26822	74.7	94.4	7.4	0.29	0.32	1.88	70	2.76	53	2.09	6000	0.339	0.185
26883	26822	74.7	94.4	7.4	0.29	0.32	1.88	70	2.76	47	1.85	6000	0.417	0.185
26884	26822	74.7	94.4	7.4	0.29	0.32	1.88	70	2.76	54	2.13	6000	0.318	0.185
26886	26822	74.7	94.4	7.4	0.29	0.32	1.88	70	2.76	52	2.05	6000	0.321	0.185
26878	26823	74.7	94.4	7.4	0.29	0.32	1.88	68	2.68	49	1.93	6000	0.382	0.143
26881	26823	74.7	94.4	7.4	0.29	0.32	1.88	68	2.68	52	2.05	6000	0.359	0.143
26882	26823	74.7	94.4	7.4	0.29	0.32	1.88	68	2.68	53	2.09	6000	0.339	0.143
26883	26823	74.7	94.4	7.4	0.29	0.32	1.88	68	2.68	47	1.85	6000	0.417	0.143
26884	26823	74.7	94.4	7.4	0.29	0.32	1.88	68	2.68	54	2.13	6000	0.318	0.143
26886	26823	74.7	94.4	7.4	0.29	0.32	1.88	68	2.68	52	2.05	6000	0.321	0.143
26878	26830	74.7	94.4	7.4	0.29	0.32	1.88	71	2.80	49	1.93	6000	0.382	0.222
26881	26830	74.7	94.4	7.4	0.29	0.32	1.88	71	2.80	52	2.05	6000	0.359	0.222
26882	26830	74.7	94.4	7.4	0.29	0.32	1.88	71	2.80	53	2.09	6000	0.339	0.222
26883	26830	74.7	94.4	7.4	0.29	0.32	1.88	71	2.80	47	1.85	6000	0.417	0.222
26884	26830	74.7	94.4	7.4	0.29	0.32	1.88	71	2.80	54	2.13	6000	0.318	0.222
26886	26830	74.7	94.4	7.4	0.29	0.32	1.88	71	2.80	52	2.05	6000	0.321	0.222
27600 SERIES														
27687	27620	96.7	152	-0.5	-0.02	0.42	1.44	115	4.53	96	3.78	3000	0.723	0.345
27689	27620	96.7	152	-0.5	-0.02	0.42	1.44	115	4.53	94	3.70	3000	0.710	0.345
27800 SERIES														
27881	27820	69.7	86	2.5	0.10	0.56	1.07	68	2.68	52	2.05	6500	0.273	0.209
28000 SERIES														
28150	28300	53.6	60.5	4.8	0.19	0.40	1.49	67	2.64	48	1.89	6500	0.267	0.137
28500 SERIES														
28579	28520	82.4	113	4.7	0.19	0.38	1.59	80	3.15	62	2.44	5000	0.464	0.197
28580	28520	82.4	113	4.7	0.19	0.38	1.59	80	3.15	64	2.52	5000	0.449	0.197
28584	28520	82.4	113	4.7	0.19	0.38	1.59	80	3.15	65	2.56	5000	0.423	0.197
28579	28521	82.4	113	4.7	0.19	0.38	1.59	83	3.27	62	2.44	5000	0.464	0.246
28580	28521	82.4	113	4.7	0.19	0.38	1.59	83	3.27	64	2.52	5000	0.449	0.246
28584	28521	82.4	113	4.7	0.19	0.38	1.59	83	3.27	65	2.56	5000	0.423	0.246
28600 SERIES														
28678	28621	86.8	125	3.4	0.13	0.40	1.49	88	3.46	67	2.64	4500	0.565	0.250
28682	28621	86.8	125	3.4	0.13	0.40	1.49	88	3.46	70	2.76	4500	0.461	0.250

INCH SERIES

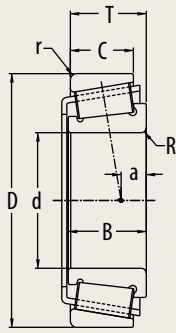

The tables include the most common industry series and sizes in the market. Additional industry series and sizes are available from PEER upon request.

Cone	Cup	d		B		R		D		C		r		T	
		Cone Bore		Cone Width		Max Shaft Radius		Cup Outer Diameter		Cup Width		Max Housing Radius		Total Width	
		mm	inch	mm	inch	mm	inch	mm	inch	mm	inch	mm	inch	mm	inch
28600 SERIES (cont.)															
28678	28622	50.800	2.0000	24.608	0.9688	3.5	0.14	97.630	3.8437	19.446	0.7656	0.8	0.03	24.608	0.9688
28682	28622	57.150	2.2500	24.608	0.9688	3.5	0.14	97.630	3.8437	19.446	0.7656	0.8	0.03	24.608	0.9688
28900 SERIES															
28980	28920	59.977	2.3613	25.400	1.0000	3.5	0.14	101.600	4.0000	19.845	0.7813	3.3	0.13	25.400	1.0000
28985	28920	60.325	2.3750	25.400	1.0000	3.5	0.14	101.600	4.0000	19.845	0.7813	3.3	0.13	25.400	1.0000
28995	28920	62.738	2.4700	25.400	1.0000	3.5	0.14	101.600	4.0000	19.845	0.7813	3.3	0.13	25.400	1.0000
28980	28921	59.977	2.3613	25.400	1.0000	3.5	0.14	100.000	3.9370	19.845	0.7813	3.3	0.13	25.400	1.0000
28985	28921	60.325	2.3750	25.400	1.0000	3.5	0.14	100.000	3.9370	19.845	0.7813	3.3	0.13	25.400	1.0000
28995	28921	62.738	2.4700	25.400	1.0000	3.5	0.14	100.000	3.9370	19.845	0.7813	3.3	0.13	25.400	1.0000
29500 SERIES															
29585	29520	63.500	2.5000	25.400	1.0000	3.5	0.14	107.950	4.2500	19.050	0.7500	3.3	0.13	25.400	1.0000
29585	29522	63.500	2.5000	25.400	1.0000	3.5	0.14	107.950	4.2500	19.050	0.7500	0.8	0.03	25.400	1.0000
29585	29521	63.500	2.5000	25.400	1.0000	3.5	0.14	110.000	4.3307	19.050	0.7500	1.3	0.05	25.400	1.0000
29600 SERIES															
29675	29620	69.850	2.7500	25.400	1.0000	1.5	0.06	112.712	4.4375	19.050	0.7500	3.3	0.13	25.400	1.0000
29685	29620	73.025	2.8750	25.400	1.0000	3.5	0.14	112.712	4.4375	19.050	0.7500	3.3	0.13	25.400	1.0000
29688	29620	73.817	2.9062	25.400	1.0000	1.5	0.06	112.712	4.4375	19.050	0.7500	3.3	0.13	25.400	1.0000
29675	29630	69.850	2.7500	25.400	1.0000	1.5	0.06	120.650	4.7500	19.050	0.7500	3.3	0.13	25.400	1.0000
29685	29630	73.025	2.8750	25.400	1.0000	3.5	0.14	120.650	4.7500	19.050	0.7500	3.3	0.13	25.400	1.0000
29688	29630	73.817	2.9062	25.400	1.0000	1.5	0.06	120.650	4.7500	19.050	0.7500	3.3	0.13	25.400	1.0000
LM29700 SERIES															
LM29748	LM29710	38.100	1.5000	18.288	0.7200	SP	SP	65.088	2.5625	13.970	0.5500	1.3	0.05	18.034	0.7100
LM29749	LM29710	38.100	1.5000	18.288	0.7200	2.3	0.09	65.088	2.5625	13.970	0.5500	1.3	0.05	18.034	0.7100
31500 SERIES															
31593	31520	34.925	1.3750	28.575	1.1250	3.5	0.14	76.200	3.0000	23.812	0.9375	3.3	0.13	29.370	1.1563
31594	31520	34.925	1.3750	28.575	1.1250	1.5	0.06	76.200	3.0000	23.812	0.9375	3.3	0.13	29.370	1.1563
31597	31520	36.512	1.4375	28.575	1.1250	3.5	0.14	76.200	3.0000	23.812	0.9375	3.3	0.13	29.370	1.1563
33000 SERIES															
33225	33462	57.150	2.2500	30.162	1.1875	3.5	0.14	117.475	4.6250	23.812	0.9375	3.3	0.13	30.162	1.1875
33262	33462	66.675	2.6250	30.162	1.1875	3.5	0.14	117.475	4.6250	23.812	0.9375	3.3	0.13	30.162	1.1875
33275	33462	69.850	2.7500	30.162	1.1875	3.5	0.14	117.475	4.6250	23.812	0.9375	3.3	0.13	30.162	1.1875
33281	33462	71.438	2.8125	30.162	1.1875	3.5	0.14	117.475	4.6250	23.812	0.9375	3.3	0.13	30.162	1.1875
33287	33462	73.025	2.8750	30.162	1.1875	3.5	0.14	117.475	4.6250	23.812	0.9375	3.3	0.13	30.162	1.1875
33225	33472	57.150	2.2500	30.162	1.1875	3.5	0.14	120.000	4.7244	23.444	0.9230	0.8	0.03	29.794	1.1730

$$P = X \cdot Fr + Y \cdot Fa$$

$\frac{F_a}{F_r} \leq e$		$\frac{F_a}{F_r} > e$	
X	Y	X	Y
1	0	0.40	See table

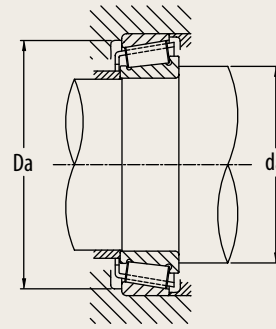

Cone	Cup	Basic Load Rating		a		e	Y Axial Load Factor	Da		da		Reference Speed RPM	Cone Weight Kg	Cup Weight Kg
		Dynamic Cr	Static Cor	Effective Load Center				Housing Bore ID		Shaft OD				
		KN	KN	mm	inch			mm	inch	mm	inch			
28600 SERIES														
28678	28622	86.8	125	3.4	0.13	0.40	1.49	88	3.46	67	2.64	4500	0.565	0.269
28682	28622	86.8	125	3.4	0.13	0.40	1.49	88	3.46	70	2.76	4500	0.461	0.269
28900 SERIES														
28980	28920	88.8	130	2.6	0.10	0.43	1.41	89	3.50	73	2.87	4000	0.531	0.265
28985	28920	88.8	130	2.6	0.10	0.43	1.41	89	3.50	74	2.91	4000	0.525	0.265
28995	28920	88.8	130	2.6	0.10	0.43	1.41	89	3.50	75	2.95	4000	0.478	0.265
28980	28921	88.8	130	2.6	0.10	0.43	1.41	89	3.50	73	2.87	4000	0.531	0.226
28985	28921	88.8	130	2.6	0.10	0.43	1.41	89	3.50	74	2.91	4000	0.525	0.226
28995	28921	88.8	130	2.6	0.10	0.43	1.41	89	3.50	75	2.95	4000	0.478	0.226
29500 SERIES														
29585	29520	90	136	0.8	0.03	0.46	1.31	95	3.74	79	3.11	4000	0.633	0.274
29585	29522	90	136	0.8	0.03	0.46	1.31	98	3.86	79	3.11	4000	0.633	0.285
29585	29521	90	136	0.8	0.03	0.46	1.31	98	3.86	79	3.11	4000	0.633	0.336
29600 SERIES														
29675	29620	92.3	145	-0.9	-0.04	0.49	1.23	100	3.94	83	3.27	3500	0.696	0.266
29685	29620	92.3	145	-0.9	-0.04	0.49	1.23	100	3.94	87	3.43	3500	0.620	0.266
29688	29620	92.3	145	-0.9	-0.04	0.49	1.23	100	3.94	85	3.35	3500	0.608	0.266
29675	29630	92.3	145	-0.9	-0.04	0.49	1.23	105	4.13	83	3.27	3500	0.696	0.481
29685	29630	92.3	145	-0.9	-0.04	0.49	1.23	105	4.13	87	3.43	3500	0.620	0.481
29688	29630	92.3	145	-0.9	-0.04	0.49	1.23	105	4.13	85	3.35	3500	0.608	0.481
LM29700 SERIES														
LM29748	LM29710	40.9	52.9	4.3	0.17	0.33	1.80	58	2.28	48	1.89	6000	0.153	0.079
LM29749	LM29710	40.9	52.9	4.3	0.17	0.33	1.80	58	2.28	47	1.85	6000	0.155	0.079
31500 SERIES														
31593	31520	78.2	93.1	7.8	0.31	0.40	1.49	64	2.52	48	1.89	7000	0.399	0.230
31594	31520	78.2	93.1	7.8	0.31	0.40	1.49	64	2.52	46	1.81	7000	0.402	0.230
31597	31520	78.2	93.1	7.8	0.31	0.40	1.49	64	2.52	49	1.93	7000	0.379	0.230
33000 SERIES														
33225	33462	115	172	2.7	0.11	0.44	1.38	104	4.09	79	3.11	4000	1.130	0.434
33262	33462	115	172	2.7	0.11	0.44	1.38	104	4.09	83	3.27	4000	0.915	0.434
33275	33462	115	172	2.7	0.11	0.44	1.38	104	4.09	85	3.35	4000	0.834	0.434
33281	33462	115	172	2.7	0.11	0.44	1.38	104	4.09	86	3.39	4000	0.792	0.434
33287	33462	115	172	2.7	0.11	0.44	1.38	104	4.09	86	3.39	4000	0.750	0.434
33225	33472	115	172	2.7	0.11	0.44	1.38	104	4.09	79	3.11	4000	1.130	0.424

INCH SERIES

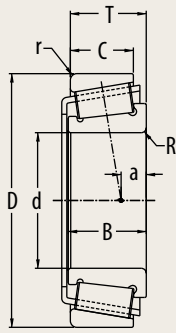

The tables include the most common industry series and sizes in the market. Additional industry series and sizes are available from PEER upon request.

Cone	Cup	d		B		R		D		C		r		T	
		Cone Bore		Cone Width		Max Shaft Radius		Cup Outer Diameter		Cup Width		Max Housing Radius		Total Width	
		mm	inch	mm	inch	mm	inch	mm	inch	mm	inch	mm	inch	mm	inch
33000 SERIES (cont.)															
33262	33472	66.675	2.6250	30.162	1.1875	3.5	0.14	120.000	4.7244	23.444	0.9230	0.8	0.03	29.794	1.1730
33275	33472	69.850	2.7500	30.162	1.1875	3.5	0.14	120.000	4.7244	23.444	0.9230	0.8	0.03	29.794	1.1730
33281	33472	71.438	2.8125	30.162	1.1875	3.5	0.14	120.000	4.7244	23.444	0.9230	0.8	0.03	29.794	1.1730
33287	33472	73.025	2.8750	30.162	1.1875	3.5	0.14	120.000	4.7244	23.444	0.9230	0.8	0.03	29.794	1.1730
33800 SERIES															
33880	33821	38.100	1.5000	28.575	1.1250	3.5	0.14	95.250	3.7500	22.225	0.8750	2.3	0.09	27.783	1.0938
33889	33821	50.800	2.0000	28.575	1.1250	3.5	0.14	95.250	3.7500	22.225	0.8750	2.3	0.09	27.783	1.0938
33891	33821	52.388	2.0625	28.575	1.1250	3.5	0.14	95.250	3.7500	22.225	0.8750	2.3	0.09	27.783	1.0938
33880	33822	38.100	1.5000	28.575	1.1250	3.5	0.14	95.250	3.7500	22.225	0.8750	0.8	0.03	27.783	1.0938
33889	33822	50.800	2.0000	28.575	1.1250	3.5	0.14	95.250	3.7500	22.225	0.8750	0.8	0.03	27.783	1.0938
33891	33822	52.388	2.0625	28.575	1.1250	3.5	0.14	95.250	3.7500	22.225	0.8750	0.8	0.03	27.783	1.0938
34000 SERIES															
34306	34478	77.788	3.0625	23.012	0.9060	3.5	0.14	121.442	4.7812	17.462	0.6875	2.0	0.08	24.607	0.9688
34306	34492A	77.788	3.0625	23.012	0.9060	3.5	0.14	125.095	4.9250	16.670	0.6563	2.0	0.08	23.731	0.9343
39000 SERIES															
39250	39412	63.500	2.5000	22.000	0.8661	2.0	0.08	104.775	4.1250	15.875	0.6250	2.0	0.08	21.433	0.8438
39500 SERIES															
39581	39520	57.150	2.2500	30.162	1.1875	8.0	0.31	112.712	4.4375	23.812	0.9375	3.3	0.13	30.162	1.1875
39585	39520	63.500	2.5000	30.162	1.1875	3.5	0.14	112.712	4.4375	23.812	0.9375	3.3	0.13	30.162	1.1875
39590	39520	66.675	2.6250	30.162	1.1875	3.5	0.14	112.712	4.4375	23.812	0.9375	3.3	0.13	30.162	1.1875
41000 SERIES															
41125	41286	28.575	1.1250	24.257	0.9550	4.8	0.19	72.626	2.8593	17.462	0.6875	1.5	0.06	24.608	0.9688
41126	41286	28.575	1.1250	24.257	0.9550	1.5	0.06	72.626	2.8593	17.462	0.6875	1.5	0.06	24.608	0.9688
42000 SERIES															
42368	42584	93.662	3.6875	28.971	1.1406	3.0	0.12	148.430	5.8437	21.433	0.8438	3.0	0.12	28.575	1.1250
42381	42584	96.838	3.8125	28.971	1.1406	3.5	0.14	148.430	5.8437	21.433	0.8438	3.0	0.12	28.575	1.1250
42600 SERIES															
42687	42620	76.200	3.0000	31.000	1.2205	3.5	0.14	127.000	5.0000	22.225	0.8750	3.3	0.13	30.162	1.1875
43000 SERIES															
43131	43312	33.338	1.3125	24.074	0.9478	3.5	0.14	79.375	3.1250	17.462	0.6875	1.5	0.06	25.400	1.0000
43132	43312	33.338	1.3125	24.074	0.9478	2.0	0.08	79.375	3.1250	17.462	0.6875	1.5	0.06	25.400	1.0000
44000 SERIES															
44162	44348	41.275	1.6250	23.698	0.9330	2.3	0.09	88.500	3.4843	17.462	0.6875	1.5	0.06	25.400	1.0000

$$P = X \cdot Fr + Y \cdot Fa$$

$\frac{Fa}{Fr} \leq e$		$\frac{Fa}{Fr} > e$	
X	Y	X	Y
1	0	0.40	See table

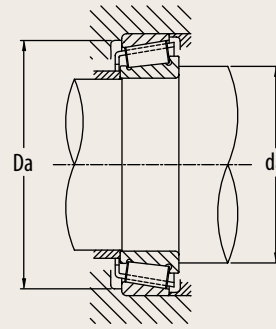

Cone	Cup	Basic Load Rating		a		e	Y Axial Load Factor	Da		da		Reference Speed RPM	Cone Weight Kg	Cup Weight Kg
		Dynamic Cr	Static Cor	Effective Load Center				Housing Bore ID		Shaft OD				
		KN	KN	mm	inch			mm	inch	mm	inch			
33000 SERIES														
33262	33472	115	172	2.7	0.11	0.44	1.38	104	4.09	83	3.27	4000	0.915	0.424
33275	33472	115	172	2.7	0.11	0.44	1.38	104	4.09	85	3.35	4000	0.834	0.424
33281	33472	115	172	2.7	0.11	0.44	1.38	104	4.09	86	3.39	4000	0.792	0.424
33287	33472	115	172	2.7	0.11	0.44	1.38	104	4.09	86	3.39	4000	0.750	0.424
33800 SERIES														
33880	33821	106	138	7.6	0.30	0.33	1.82	85	3.35	59	2.32	5000	0.776	0.265
33889	33821	106	138	7.6	0.30	0.33	1.82	85	3.35	65	2.56	5000	0.577	0.265
33891	33821	106	138	7.6	0.30	0.33	1.82	85	3.35	66	2.60	5000	0.548	0.265
33880	33822	106	138	7.6	0.30	0.33	1.82	86	3.39	59	2.32	5000	0.776	0.269
33889	33822	106	138	7.6	0.30	0.33	1.82	86	3.39	65	2.56	5000	0.577	0.269
33891	33822	106	138	7.6	0.30	0.33	1.82	86	3.39	66	2.60	5000	0.548	0.269
34000 SERIES														
34306	34478	86.6	120	1.6	0.06	0.45	1.33	110	4.33	89	3.50	3500	0.607	0.313
34306	34492A	86.6	120	1.6	0.06	0.45	1.33	112	4.41	89	3.50	3500	0.607	0.396
39000 SERIES														
39250	39412	87.8	111	1.2	0.05	0.39	1.55	96	3.78	74	2.91	4000	0.505	0.184
39500 SERIES														
39581	39520	138	193	6.5	0.26	0.34	1.77	101	3.98	80	3.15	4000	1.020	0.351
39585	39520	138	193	6.5	0.26	0.34	1.77	101	3.98	79	3.11	4000	0.900	0.351
39590	39520	138	193	6.5	0.26	0.34	1.77	101	3.98	80	3.15	4000	0.823	0.351
41000 SERIES														
41125	41286	59	57	4.2	0.17	0.60	1.00	61	2.40	43	1.69	8500	0.294	0.177
41126	41286	59	57	4.2	0.17	0.60	1.00	61	2.40	40	1.57	8500	0.298	0.177
42000 SERIES														
42368	42584	137	214	-3.0	-0.12	0.49	1.22	134	5.28	110	4.33	2800	1.270	0.544
42381	42584	137	214	-3.0	-0.12	0.49	1.22	134	5.28	112	4.41	2800	1.150	0.544
42600 SERIES														
42687	42620	138	199	3.1	0.12	0.42	1.43	113	4.45	92	3.62	3500	1.010	0.430
43000 SERIES														
43131	43312	66.6	68.8	2.0	0.08	0.67	0.90	66	2.60	47	1.85	7000	0.350	0.218
43132	43312	66.6	68.8	2.0	0.08	0.67	0.90	66	2.60	45	1.77	7000	0.352	0.218
44000 SERIES														
44162	44348	71.8	79.5	2.3	0.09	0.78	0.77	75	2.95	55	2.17	6000	0.434	0.243

INCH SERIES

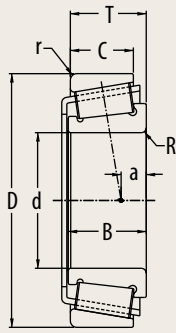

The tables include the most common industry series and sizes in the market. Additional industry series and sizes are available from PEER upon request.

Cone	Cup	d		B		R		D		C		r		T	
		Cone Bore		Cone Width		Max Shaft Radius		Cup Outer Diameter		Cup Width		Max Housing Radius		Total Width	
		mm	inch	mm	inch	mm	inch	mm	inch	mm	inch	mm	inch	mm	inch
L44600 SERIES															
L44640	L44610	23.812	0.9375	14.732	0.5800	1.5	0.06	50.292	1.9800	10.668	0.4200	1.3	0.05	14.224	0.5600
L44643	L44610	25.400	1.0000	14.732	0.5800	1.3	0.05	50.292	1.9800	10.668	0.4200	1.3	0.05	14.224	0.5600
L44649	L44610	26.988	1.0625	14.732	0.5800	3.5	0.14	50.292	1.9800	10.668	0.4200	1.3	0.05	14.224	0.5600
45200 SERIES															
45280	45220	44.450	1.7500	30.958	1.2188	0.8	0.03	104.775	4.1250	23.812	0.9375	3.3	0.13	30.162	1.1875
45282	45220	47.625	1.8750	30.958	1.2188	3.5	0.14	104.775	4.1250	23.812	0.9375	3.3	0.13	30.162	1.1875
45284	45220	50.800	2.0000	30.958	1.2188	6.4	0.25	104.775	4.1250	23.812	0.9375	3.3	0.13	30.162	1.1875
45280	45221	44.450	1.7500	30.958	1.2188	0.8	0.03	104.775	4.1250	23.812	0.9375	0.8	0.03	30.162	1.1875
45282	45221	47.625	1.8750	30.958	1.2188	3.5	0.14	104.775	4.1250	23.812	0.9375	0.8	0.03	30.162	1.1875
45284	45221	50.800	2.0000	30.958	1.2188	6.4	0.25	104.775	4.1250	23.812	0.9375	0.8	0.03	30.162	1.1875
L45400 SERIES															
L45449	L45410	29.000	1.1417	14.732	0.5800	3.5	0.14	50.292	1.9800	10.668	0.4200	1.3	0.05	14.224	0.5600
46000 SERIES															
46143	46368	36.512	1.4375	31.750	1.2500	1.5	0.06	93.662	3.6875	26.195	1.0313	3.3	0.13	31.750	1.2500
46162	46368	41.275	1.6250	31.750	1.2500	0.8	0.03	93.662	3.6875	26.195	1.0313	3.3	0.13	31.750	1.2500
46176	46368	44.450	1.7500	31.750	1.2500	3.5	0.14	93.662	3.6875	26.195	1.0313	3.3	0.13	31.750	1.2500
46700 SERIES															
46790	46720	165.100	6.5000	39.688	1.5625	3.5	0.14	225.425	8.8750	33.338	1.3125	3.3	0.13	41.275	1.6250
47400 SERIES															
47487	47420A	69.850	2.7500	32.545	1.2813	3.5	0.14	120.000	4.7244	26.195	1.0313	0.5	0.02	32.545	1.2813
47600 SERIES															
47678	47620	76.200	3.0000	33.338	1.3125	6.4	0.25	133.350	5.2500	26.195	1.0313	3.3	0.13	33.338	1.3125
47679	47620	76.200	3.0000	33.338	1.3125	3.5	0.14	133.350	5.2500	26.195	1.0313	3.3	0.13	33.338	1.3125
47681	47620	80.962	3.1875	33.338	1.3125	3.5	0.14	133.350	5.2500	26.195	1.0313	3.3	0.13	33.338	1.3125
47685	47620	82.550	3.2500	33.338	1.3125	0.8	0.03	133.350	5.2500	26.195	1.0313	3.3	0.13	33.338	1.3125
47686	47620	82.550	3.2500	33.338	1.3125	3.5	0.14	133.350	5.2500	26.195	1.0313	3.3	0.13	33.338	1.3125
47687	47620	82.550	3.2500	33.338	1.3125	6.8	0.27	133.350	5.2500	26.195	1.0313	3.3	0.13	33.338	1.3125
47800 SERIES															
47890	47820	92.075	3.6250	34.925	1.3750	3.5	0.14	146.050	5.7500	26.195	1.0313	3.3	0.13	33.338	1.3125
47896	47820	95.250	3.7500	34.925	1.3750	3.5	0.14	146.050	5.7500	26.195	1.0313	3.3	0.13	33.338	1.3125
48200 SERIES															
48286	48220	123.825	4.8750	38.100	1.5000	3.5	0.14	182.562	7.1875	33.338	1.3125	3.3	0.13	39.688	1.5626
LM48500 SERIES															
LM48548	LM48510	34.925	1.3750	18.288	0.7200	SP	SP	65.088	2.5625	13.970	0.5500	1.3	0.05	18.034	0.7100

$$P = X \cdot Fr + Y \cdot Fa$$

$\frac{Fa}{Fr} \leq e$		$\frac{Fa}{Fr} > e$	
X	Y	X	Y
1	0	0.40	See table

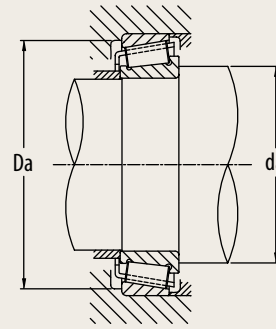

Cone	Cup	Basic Load Rating		a		e	Y Axial Load Factor	Da		da		Reference Speed RPM	Cone Weight Kg	Cup Weight Kg
		Dynamic Cr	Static Cor	Effective Load Center				Housing Bore ID		Shaft OD				
		KN	KN	mm	inch			mm	inch	mm	inch			
L44600 SERIES														
L44640	L44610	25.7	29.2	3.2	0.13	0.37	1.60	44	1.73	32	1.26	8000	0.094	0.039
L44643	L44610	25.7	29.2	3.2	0.13	0.37	1.60	44	1.73	32	1.26	8000	0.087	0.039
L44649	L44610	25.7	29.2	3.2	0.13	0.37	1.60	44	1.73	36	1.42	8000	0.079	0.039
45200 SERIES														
45280	45220	126	163	7.9	0.31	0.33	1.80	92	3.62	62	2.44	4400	0.996	0.341
45282	45220	126	163	7.9	0.31	0.33	1.80	92	3.62	66	2.60	4500	0.936	0.341
45284	45220	126	163	7.9	0.31	0.33	1.80	92	3.62	68	2.68	4500	0.865	0.341
45280	45221	126	163	7.9	0.31	0.33	1.80	95	3.74	62	2.44	4400	0.996	0.351
45282	45221	126	163	7.9	0.31	0.33	1.80	95	3.74	66	2.60	4500	0.936	0.351
45284	45221	126	163	7.9	0.31	0.33	1.80	95	3.74	68	2.68	4500	0.865	0.351
L45400 SERIES														
L45449	L45410	25.7	31.8	3.3	0.13	0.37	1.62	44	1.73	38	1.50	8000	0.075	0.036
46000 SERIES														
46143	46368	107	137	7.7	0.30	0.40	1.49	80	3.15	53	2.09	5500	0.736	0.401
46162	46368	107	137	7.7	0.30	0.40	1.49	80	3.15	55	2.17	5500	0.665	0.401
46176	46368	107	137	7.7	0.30	0.40	1.49	80	3.15	59	2.32	5500	0.607	0.401
46700 SERIES														
46790	46720	265	570	-3.0	-0.12	0.38	1.57	208	8.19	184	7.24	1800	3.000	1.640
47400 SERIES														
47487	47420A	147	214	5.7	0.22	0.36	1.67	110	4.33	85	3.35	3900	0.970	0.487
47600 SERIES														
47678	47620	149	227	4.2	0.17	0.40	1.48	119	4.69	98	3.86	3500	1.320	0.568
47679	47620	149	227	4.2	0.17	0.40	1.48	119	4.69	95	3.74	3500	1.330	0.568
47681	47620	149	227	4.2	0.17	0.40	1.48	119	4.69	100	3.94	3600	1.160	0.568
47685	47620	149	227	4.2	0.17	0.40	1.48	119	4.69	95	3.74	3600	1.140	0.568
47686	47620	149	227	4.2	0.17	0.40	1.48	119	4.69	98	3.86	3600	1.130	0.568
47687	47620	149	227	4.2	0.17	0.40	1.48	119	4.69	101	3.98	3600	1.110	0.568
47800 SERIES														
47890	47820	172	281	1.2	0.05	0.45	1.34	131	5.16	109	4.29	2800	1.410	0.654
47896	47820	172	281	1.2	0.05	0.45	1.34	131	5.16	110	4.33	2800	1.290	0.654
48200 SERIES														
48286	48220	221	413	5.6	0.22	0.31	1.97	168	6.61	142	5.59	2200	2.250	1.130
LM48500 SERIES														
LM48548	LM48510	45.7	54.9	3.6	0.14	0.38	1.59	58	2.28	45	1.77	6500	0.164	0.086

INCH SERIES

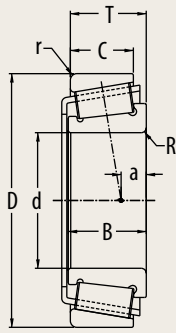

The tables include the most common industry series and sizes in the market. Additional industry series and sizes are available from PEER upon request.

Cone	Cup	d		B		R		D		C		r		T	
		Cone Bore		Cone Width		Max Shaft Radius		Cup Outer Diameter		Cup Width		Max Housing Radius		Total Width	
		mm	inch	mm	inch	mm	inch	mm	inch	mm	inch	mm	inch	mm	inch
48600 SERIES															
48684	48620	142.875	5.6250	39.688	1.5625	7.9	0.31	200.025	7.8750	34.130	1.3437	3.3	0.13	77.788	3.0625
49000 SERIES															
49175	49368	44.450	1.7500	31.750	1.2500	3.5	0.14	93.662	3.6875	25.400	1.0000	3.3	0.13	31.750	1.2500
49500 SERIES															
49580	49520	47.625	1.8750	31.750	1.2500	3.5	0.14	101.600	4.0000	25.400	1.0000	3.3	0.13	31.750	1.2500
52000 SERIES															
52387	52618	98.425	3.8750	36.116	1.4219	3.5	0.14	157.162	6.1875	26.195	1.0313	3.3	0.13	36.512	1.4375
52400	52618	101.600	4.0000	36.116	1.4219	3.5	0.14	157.162	6.1875	26.195	1.0313	3.3	0.13	36.512	1.4375
52401	52618	101.600	4.0000	36.116	1.4219	8.0	0.31	157.162	6.1875	26.195	1.0313	3.3	0.13	36.512	1.4375
52387	52638	98.425	3.8750	36.116	1.4219	3.5	0.14	161.925	6.3750	29.370	1.1563	3.3	0.13	39.687	1.5625
52400	52638	101.600	4.0000	36.116	1.4219	3.5	0.14	161.925	6.3750	29.370	1.1563	3.3	0.13	39.687	1.5625
52401	52638	101.600	4.0000	36.116	1.4219	8.0	0.31	161.925	6.3750	29.370	1.1563	3.3	0.13	39.687	1.5625
53000 SERIES															
53178	53375	44.450	1.7500	28.300	1.1142	2.0	0.08	95.250	3.7500	20.638	0.8125	0.8	0.03	30.958	1.2188
55000C SERIES															
55175C	55437	44.450	1.7500	26.909	1.0594	3.5	0.14	111.125	4.3750	20.638	0.8125	3.3	0.13	30.162	1.1875
55200C	55437	50.800	2.0000	26.909	1.0594	3.5	0.14	111.125	4.3750	20.638	0.8125	3.3	0.13	30.162	1.1875
55175C	55443	44.450	1.7500	26.909	1.0594	3.5	0.14	112.712	4.4375	20.638	0.8125	3.3	0.13	30.162	1.1875
55200C	55443	50.800	2.0000	26.909	1.0594	3.5	0.14	112.712	4.4375	20.638	0.8125	3.3	0.13	30.162	1.1875
56000 SERIES															
56418	56650	106.362	4.1875	36.512	1.4375	3.5	0.14	165.100	6.5000	26.988	1.0625	3.3	0.13	36.512	1.4375
56425	56650	107.950	4.2500	36.512	1.4375	3.5	0.14	165.100	6.5000	26.988	1.0625	3.3	0.13	36.512	1.4375
59000 SERIES															
59162	59412	41.275	1.6250	36.512	1.4375	1.5	0.06	104.775	4.1250	28.575	1.1250	3.3	0.13	36.512	1.4375
59200	59412	50.800	2.0000	36.512	1.4375	3.5	0.14	104.775	4.1250	28.575	1.1250	3.3	0.13	36.512	1.4375
64000 SERIES															
64450	64700	114.300	4.5000	41.275	1.6250	3.5	0.14	177.800	7.0000	30.162	1.1875	3.3	0.13	41.275	1.6250
65000 SERIES															
65237	65500	60.325	2.3750	44.450	1.7500	3.5	0.14	127.000	5.0000	34.925	1.3750	3.3	0.13	44.450	1.7500
65300 SERIES															
65385	65320	44.450	1.7500	44.450	1.7500	3.5	0.14	114.300	4.5000	34.925	1.3750	3.3	0.13	44.450	1.7500
65390	65320	49.212	1.9375	44.450	1.7500	3.5	0.14	114.300	4.5000	34.925	1.3750	3.3	0.13	44.450	1.7500

$$P = X \cdot Fr + Y \cdot Fa$$

$\frac{Fa}{Fr} \leq e$		$\frac{Fa}{Fr} > e$	
X	Y	X	Y
1	0	0.40	See table

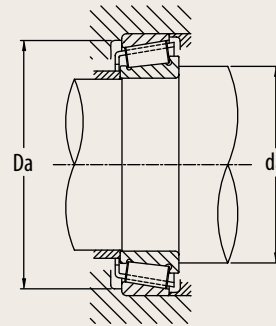

Cone	Cup	Basic Load Rating		a		e	Y	Da		da		Reference Speed RPM	Cone Weight Kg	Cup Weight Kg	
		Dynamic Cr	Static Cor	Effective Load Center				Axial Load Factor	Housing Bore ID		Shaft OD				
		KN	KN	mm	inch				mm	inch	mm				inch
48600 SERIES															
48684	48620	248	498	2.7	0.11	0.34	1.78	184	7.24	165	6.50	2000	2.420	1.380	
49000 SERIES															
49175	49368	111	134	9.8	0.39	0.36	1.67	80	3.15	59	2.32	6000	0.633	0.365	
49500 SERIES															
49580	49520	110	136	7.8	0.31	0.40	1.50	88	3.46	65	2.56	5000	0.794	0.383	
52000 SERIES															
52387	52618	186	299	0.5	0.02	0.47	1.26	142	5.59	118	4.65	3000	1.870	0.691	
52400	52618	186	299	0.5	0.02	0.47	1.26	142	5.59	117	4.61	3000	1.730	0.691	
52401	52618	186	299	0.5	0.02	0.47	1.26	142	5.59	123	4.84	3000	1.690	0.691	
52387	52638	186	299	0.5	0.02	0.47	1.26	143	5.63	118	4.65	3000	1.870	1.100	
52400	52638	186	299	0.5	0.02	0.47	1.26	143	5.63	117	4.61	3000	1.730	1.100	
52401	52638	186	299	0.5	0.02	0.47	1.26	143	5.63	123	4.84	3000	1.690	1.100	
53000 SERIES															
53178	53375	83.8	91.7	0.3	0.01	0.74	0.81	81	3.19	58	2.28	6500	0.555	0.366	
55000C SERIES															
55175C	55437	111	150	-7.4	-0.29	0.88	0.68	91	3.58	67	2.64	5500	0.953	0.506	
55200C	55437	111	150	-7.4	-0.29	0.88	0.68	91	3.58	70	2.76	5500	0.852	0.506	
55175C	55443	111	150	-7.4	-0.29	0.88	0.68	92	3.62	67	2.64	5500	0.953	0.551	
55200C	55443	111	150	-7.4	-0.29	0.88	0.68	92	3.62	70	2.76	5500	0.852	0.551	
56000 SERIES															
56418	56650	194	322	2.2	0.09	0.50	1.21	149	5.87	125	4.92	2800	1.890	0.849	
56425	56650	194	322	2.2	0.09	0.50	1.21	149	5.87	124	4.88	2800	1.820	0.849	
59000 SERIES															
59162	59412	139	191	9.8	0.39	0.40	1.49	89	3.50	61	2.40	5000	1.130	0.534	
59200	59412	139	191	9.8	0.39	0.40	1.49	89	3.50	67	2.64	5000	0.924	0.534	
64000 SERIES															
64450	64700	228	366	-1.5	-0.06	0.52	1.16	160	6.30	134	5.28	2800	2.380	1.100	
65000 SERIES															
65237	65500	202	261	9.4	0.37	0.49	1.23	108	4.25	79	3.11	4800	1.570	1.020	
65300 SERIES															
65385	65320	184	222	12.6	0.50	0.43	1.39	96	3.78	65	2.56	5500	1.450	0.662	
65390	65320	184	222	12.6	0.50	0.43	1.39	96	3.78	67	2.64	5500	1.320	0.662	

INCH SERIES

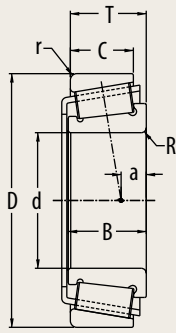

The tables include the most common industry series and sizes in the market. Additional industry series and sizes are available from PEER upon request.

Cone	Cup	d		B		R		D		C		r		T	
		Cone Bore		Cone Width		Max Shaft Radius		Cup Outer Diameter		Cup Width		Max Housing Radius		Total Width	
		mm	inch	mm	inch	mm	inch	mm	inch	mm	inch	mm	inch	mm	inch
LM67000 SERIES															
LM67048	LM67010	31.750	1.2500	16.764	0.6600	SP	SP	59.131	2.3280	11.811	0.4650	1.3	0.05	15.875	0.6250
LM67049A	LM67010	31.750	1.2500	16.764	0.6600	0.8	0.03	59.131	2.3280	11.811	0.4650	1.3	0.05	15.875	0.6250
67300 SERIES															
67388	67322	127.000	5.0000	46.038	1.8125	3.5	0.14	196.850	7.7500	38.100	1.5000	3.3	0.13	46.038	1.8125
67390	67322	133.350	5.2500	46.038	1.8125	3.5	0.14	196.850	7.7500	38.100	1.5000	3.3	0.13	46.038	1.8125
67388	67324	127.000	5.0000	46.038	1.8125	3.5	0.14	203.200	8.0000	46.038	1.8125	3.3	0.13	46.038	1.8125
67390	67324	133.350	5.2500	46.038	1.8125	3.5	0.14	203.200	8.0000	46.038	1.8125	3.3	0.13	46.038	1.8125
L68100 SERIES															
L68149	L68110	34.988	1.3775	16.764	0.6600	SP	SP	59.131	2.3280	11.938	0.4700	1.3	0.05	15.875	0.6250
L68149	L68111	34.988	1.3775	16.764	0.6600	SP	SP	59.974	2.3612	11.938	0.4700	1.3	0.05	15.875	0.6250
L69300 SERIES															
JL69349	JL69310	38.000	1.4961	17.000	0.6693	SP	SP	63.000	2.4803	13.500	0.5315	1.5	0.06	17.000	0.6693
JL69349	JL69310P	38.000	1.4961	17.000	0.6693	SP	SP	63.000	2.4803	13.500	0.5315	1.5	0.06	17.000	0.6693
72000C SERIES															
72188C	72487	47.625	1.8750	32.791	1.2910	0.8	0.03	123.825	4.8750	25.400	1.0000	3.3	0.13	36.512	1.4375
72200C	72487	50.800	2.0000	32.791	1.2910	3.5	0.14	123.825	4.8750	25.400	1.0000	3.3	0.13	36.512	1.4375
72201C	72487	50.800	2.0000	32.791	1.2910	0.8	0.03	123.825	4.8750	25.400	1.0000	3.3	0.13	36.512	1.4375
72213C	72487	53.975	2.1250	32.791	1.2910	3.5	0.14	123.825	4.8750	25.400	1.0000	3.3	0.13	36.512	1.4375
72225C	72487	57.150	2.2500	32.791	1.2910	3.5	0.14	123.825	4.8750	25.400	1.0000	3.3	0.13	36.512	1.4375
LM72800 SERIES															
LM72849	LM72810	22.606	0.8900	15.500	0.6102	1.5	0.06	47.000	1.8504	12.000	0.4724	1.0	0.04	15.500	0.6102
78000 SERIES															
78225	78537	57.150	2.2500	33.236	1.3085	3.5	0.14	136.525	5.3750	23.520	0.9260	3.3	0.13	36.512	1.4375
78225	78551	57.150	2.2500	33.236	1.3085	3.5	0.14	140.030	5.5130	23.520	0.9260	2.3	0.09	36.512	1.4375
78000C SERIES															
78225C	78551	57.150	2.2500	33.236	1.3085	3.5	0.14	140.030	5.5130	23.520	0.9260	2.3	0.09	36.512	1.4375
LM78300 SERIES															
LM78349	LM78310A	34.988	1.3775	17.000	0.6693	3.5	0.14	61.973	2.4399	13.600	0.5354	1.5	0.06	16.700	0.6575
HM81600 SERIES															
HM81649	HM81610	15.987	0.6294	21.000	0.8268	1.0	0.04	46.975	1.8494	16.000	0.6299	2.0	0.08	21.000	0.8268
M84200 SERIES															
M84249	M84210	25.400	1.0000	23.114	0.9100	0.8	0.03	59.530	2.3437	18.288	0.7200	1.5	0.06	23.368	0.9200

$$P = X \cdot Fr + Y \cdot Fa$$

$\frac{Fa}{Fr} \leq e$		$\frac{Fa}{Fr} > e$	
X	Y	X	Y
1	0	0.40	See table

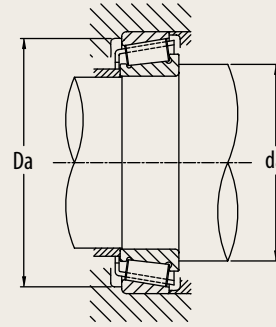

Cone	Cup	Basic Load Rating		a		e	Y Axial Load Factor	Da		da		Reference Speed RPM	Cone Weight Kg	Cup Weight Kg
		Dynamic Cr	Static Cor	Effective Load Center				Housing Bore ID		Shaft OD				
		KN	KN	mm	inch			mm	inch	mm	inch			
LM67000 SERIES														
LM67048	LM67010	32.9	38.6	2.9	0.11	0.41	1.46	52	2.05	42	1.65	7500	0.117	0.062
LM67049A	LM67010	32.9	38.6	2.9	0.11	0.41	1.46	52	2.05	39	1.54	7500	0.121	0.062
67300 SERIES														
67388	67322	305	545	6.3	0.25	0.34	1.74	181	7.13	148	5.83	2000	3.590	1.450
67390	67322	305	545	6.3	0.25	0.34	1.74	181	7.13	152	5.98	2000	3.130	1.450
67388	67324	305	545	6.3	0.25	0.34	1.74	184	7.24	148	5.83	2000	3.590	2.040
67390	67324	305	545	6.3	0.25	0.34	1.74	184	7.24	152	5.98	2000	3.130	2.040
L68100 SERIES														
L68149	L68110	32.7	43.2	2.6	0.10	0.42	1.44	52	2.05	45	1.77	7000	0.114	0.056
L68149	L68111	32.7	43.2	2.6	0.10	0.42	1.44	52	2.05	45	1.77	7000	0.114	0.063
L69300 SERIES														
JL69349	JL69310	36.3	48.3	2.0	0.08	0.42	1.44	56	2.20	47	1.85	6500	0.130	0.071
JL69349	JL69310P	36.3	48.3	2.0	0.08	0.42	1.44	56	2.20	47	1.85	6500	0.130	0.071
72000C SERIES														
72188C	72487	152	184	-2.2	-0.09	0.74	0.81	103	4.06	68	2.68	4500	1.370	0.781
72200C	72487	152	184	-2.2	-0.09	0.74	0.81	103	4.06	72	2.83	4500	1.230	0.781
72201C	72487	152	184	-2.2	-0.09	0.74	0.81	103	4.06	69	2.72	4500	1.300	0.781
72213C	72487	152	184	-2.2	-0.09	0.74	0.81	103	4.06	74	2.91	4500	1.230	0.781
72225C	72487	152	184	-2.2	-0.09	0.74	0.81	103	4.06	76	2.99	4500	1.160	0.781
LM72800 SERIES														
LM72849	LM72810	25.8	29.5	3.7	0.15	0.47	1.27	40	1.57	32	1.26	10000	0.077	0.048
78000 SERIES														
78225	78551	148	174	-7.8	-0.31	0.87	0.69	115	4.53	81	3.19	3600	1.600	0.772
78225	78537	148	174	-7.8	-0.31	0.87	0.69	118	4.65	81	3.19	3600	1.600	0.919
78000C SERIES														
78225C	78551	147	172	-8.0	-0.31	0.87	0.69	119	4.69	82	3.23	4500	1.610	0.919
LM78300 SERIES														
LM78349	LM78310A	37.3	48.5	2.4	0.09	0.44	1.35	54	2.13	45	1.77	6500	0.135	0.074
HM81600 SERIES														
HM81649	HM81610	34.4	35	6.1	0.24	0.55	1.10	37	1.46	25	0.98	12000	0.111	0.080
M84200 SERIES														
M84249	M84210	48.5	55.8	5.1	0.20	0.55	1.10	49	1.93	35	1.38	9000	0.193	0.129

INCH SERIES

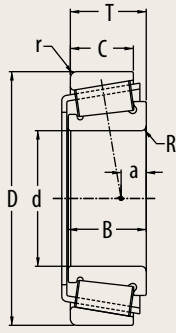

The tables include the most common industry series and sizes in the market. Additional industry series and sizes are available from PEER upon request.

Cone	Cup	d		B		R		D		C		r		T	
		Cone Bore		Cone Width		Max Shaft Radius		Cup Outer Diameter		Cup Width		Max Housing Radius		Total Width	
		mm	inch	mm	inch	mm	inch	mm	inch	mm	inch	mm	inch	mm	inch
M84500 SERIES															
M84548	M84510	25.400	1.0000	19.431	0.7650	1.5	0.06	57.150	2.2500	14.732	0.5800	1.5	0.06	19.431	0.7650
M86600 SERIES															
M86643	M86610	25.400	1.0000	21.433	0.8438	1.5	0.06	64.292	2.5312	16.670	0.6563	1.5	0.06	21.433	0.8438
M86649	M86610	30.162	1.1875	21.433	0.8438	1.5	0.06	64.292	2.5312	16.670	0.6563	1.5	0.06	21.433	0.8438
M88000 SERIES															
M88047	M88010	33.338	1.3125	22.225	0.8750	5.5	0.22	68.262	2.6875	17.462	0.6875	1.5	0.06	22.225	0.8750
M88048	M88010	33.338	1.3125	22.225	0.8750	0.8	0.03	68.262	2.6875	17.462	0.6875	1.5	0.06	22.225	0.8750
HM88500 SERIES															
HM88542	HM88510	31.750	1.2500	27.783	1.0938	1.3	0.05	73.025	2.8750	23.020	0.9063	3.3	0.13	29.370	1.1563
HM88547	HM88510	33.338	1.3125	27.783	1.0938	0.8	0.03	73.025	2.8750	23.020	0.9063	3.3	0.13	29.370	1.1563
HM88600 SERIES															
HM88630	HM88610	25.400	1.0000	25.400	1.0000	0.8	0.03	72.233	2.8438	19.842	0.7812	2.3	0.09	25.400	1.0000
HM88648	HM88610	35.717	1.4062	25.400	1.0000	3.5	0.14	72.233	2.8438	19.842	0.7812	2.3	0.09	25.400	1.0000
HM88649	HM88610	34.925	1.3750	25.400	1.0000	2.3	0.09	72.233	2.8438	19.842	0.7812	2.3	0.09	25.400	1.0000
HM88630	HM88611	25.400	1.0000	25.400	1.0000	0.8	0.03	71.973	2.8336	21.443	0.8442	1.5	0.06	27.000	1.0630
HM88648	HM88611	35.717	1.4062	25.400	1.0000	3.5	0.14	71.973	2.8336	21.443	0.8442	1.5	0.06	27.000	1.0630
HM88649	HM88611	34.925	1.3750	25.400	1.0000	2.3	0.09	71.973	2.8336	21.443	0.8442	1.5	0.06	27.000	1.0630
HM89200 SERIES															
HM89249	HM89210	36.512	1.4375	28.829	1.1350	3.5	0.14	79.375	3.1250	22.664	0.8923	3.3	0.13	29.370	1.1563
HM89400 SERIES															
HM89440	HM89410	31.750	1.2500	28.575	1.1250	0.8	0.03	76.200	3.0000	23.020	0.9063	3.3	0.13	29.369	1.1563
HM89443	HM89410	33.338	1.3125	28.575	1.1250	0.8	0.03	76.200	3.0000	23.020	0.9063	3.3	0.13	29.369	1.1563
HM89446	HM89410	34.925	1.3750	28.575	1.1250	3.5	0.14	76.200	3.0000	23.020	0.9063	3.3	0.13	29.369	1.1563
HM89448	HM89410	36.512	1.4375	28.575	1.1250	0.8	0.03	76.200	3.0000	23.020	0.9063	3.3	0.13	29.369	1.1563
HM89449	HM89410	36.512	1.4375	28.575	1.1250	3.5	0.14	76.200	3.0000	23.020	0.9063	3.3	0.13	29.369	1.1563
HM89440	HM89411	31.750	1.2500	28.575	1.1250	0.8	0.03	76.200	3.0000	23.020	0.9063	0.8	0.03	29.369	1.1563
HM89443	HM89411	33.338	1.3125	28.575	1.1250	0.8	0.03	76.200	3.0000	23.020	0.9063	0.8	0.03	29.369	1.1563
HM89446	HM89411	34.925	1.3750	28.575	1.1250	3.5	0.14	76.200	3.0000	23.020	0.9063	0.8	0.03	29.369	1.1563
HM89448	HM89411	36.512	1.4375	28.575	1.1250	0.8	0.03	76.200	3.0000	23.020	0.9063	0.8	0.03	29.369	1.1563
HM89449	HM89411	36.512	1.4375	28.575	1.1250	3.5	0.14	76.200	3.0000	23.020	0.9063	0.8	0.03	29.369	1.1563
LM102900 SERIES															
LM102949	LM102910	45.242	1.7812	19.812	0.7800	3.5	0.14	73.431	2.8910	15.748	0.6200	0.8	0.03	19.558	0.7700

$$P = X \cdot Fr + Y \cdot Fa$$

$\frac{Fa}{Fr} \leq e$		$\frac{Fa}{Fr} > e$	
X	Y	X	Y
1	0	0.40	See table

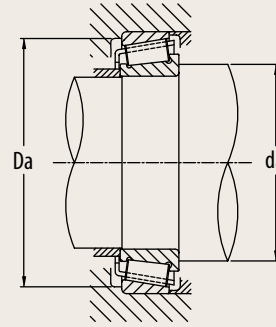

Cone	Cup	Basic Load Rating		a		e	Y Axial Load Factor	Da		da		Reference Speed RPM	Cone Weight Kg	Cup Weight Kg
		Dynamic Cr	Static Cor	Effective Load Center				Housing Bore ID		Shaft OD				
		KN	KN	mm	inch			mm	inch	mm	inch			
M84500 SERIES														
M84548	M84510	40.9	46.6	3.5	0.14	0.55	1.10	48	1.89	35	1.38	9000	0.150	0.088
M86600 SERIES														
M86643	M86610	50.1	62.4	3.2	0.13	0.55	1.10	54	2.13	38	1.50	7500	0.240	0.127
M86649	M86610	50.1	62.4	3.2	0.13	0.55	1.10	54	2.13	40	1.57	7500	0.205	0.127
M88000 SERIES														
M88047	M88010	53.5	67.3	2.8	0.11	0.55	1.10	58	2.28	48	1.89	7000	0.225	0.145
M88048	M88010	53.5	67.3	2.8	0.11	0.55	1.10	58	2.28	44	1.73	7000	0.233	0.145
HM88500 SERIES														
HM88542	HM88510	72.4	97.3	5.6	0.22	0.55	1.10	59	2.32	45	1.77	7000	0.376	0.236
HM88547	HM88510	72.4	97.3	5.6	0.22	0.55	1.10	59	2.32	45	1.77	7000	0.359	0.236
HM88600 SERIES														
HM88630	HM88610	63.8	82.7	4.5	0.18	0.55	1.10	60	2.36	41	1.61	6500	0.394	0.185
HM88648	HM88610	63.8	82.7	4.5	0.18	0.55	1.10	60	2.36	49	1.93	6500	0.292	0.185
HM88649	HM88610	63.8	82.7	4.5	0.18	0.55	1.10	60	2.36	47	1.85	6500	0.303	0.185
HM88630	HM88611	63.8	82.7	4.5	0.18	0.55	1.10	59	2.32	41	1.61	6500	0.394	0.204
HM88648	HM88611	63.8	82.7	4.5	0.18	0.55	1.10	59	2.32	49	1.93	6500	0.292	0.204
HM88649	HM88611	63.8	82.7	4.5	0.18	0.55	1.10	59	2.32	47	1.85	6500	0.303	0.204
HM89200 SERIES														
HM89249	HM89210	85.8	103	5.8	0.23	0.55	1.10	65	2.56	59	2.32	7000	0.419	0.249
HM89400 SERIES														
HM89440	HM89410	76.4	102.6	5.5	0.22	0.55	1.10	62	2.44	45	1.77	7000	0.435	0.251
HM89443	HM89410	76.4	102.6	5.5	0.22	0.55	1.10	62	2.44	46	1.81	7000	0.417	0.251
HM89446	HM89410	76.4	102.6	5.5	0.22	0.55	1.10	62	2.44	50	1.97	7000	0.394	0.251
HM89448	HM89410	76.4	102.6	5.5	0.22	0.55	1.10	62	2.44	48	1.89	7000	0.378	0.251
HM89449	HM89410	76.4	102.6	5.5	0.22	0.55	1.10	62	2.44	51	2.01	7000	0.374	0.251
HM89440	HM89411	76.4	102.6	5.5	0.22	0.55	1.10	62	2.44	45	1.77	7000	0.435	0.259
HM89443	HM89411	76.4	102.6	5.5	0.22	0.55	1.10	62	2.44	46	1.81	7000	0.417	0.259
HM89446	HM89411	76.4	102.6	5.5	0.22	0.55	1.10	62	2.44	50	1.97	7000	0.394	0.259
HM89448	HM89411	76.4	102.6	5.5	0.22	0.55	1.10	62	2.44	48	1.89	7000	0.378	0.259
HM89449	HM89411	76.4	102.6	5.5	0.22	0.55	1.10	62	2.44	51	2.01	7000	0.374	0.259
LM102900 SERIES														
LM102949	LM102910	53.3	73.4	4.9	0.19	0.31	1.97	67	2.64	55	2.17	5500	0.205	0.101

INCH SERIES

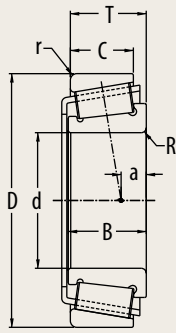

The tables include the most common industry series and sizes in the market. Additional industry series and sizes are available from PEER upon request.

Cone	Cup	d		B		R		D		C		r		T	
		Cone Bore		Cone Width		Max Shaft Radius		Cup Outer Diameter		Cup Width		Max Housing Radius		Total Width	
		mm	inch	mm	inch	mm	inch	mm	inch	mm	inch	mm	inch	mm	inch
LM104900 SERIES															
JLM104948	JLM104910	50.000	1.9685	21.500	0.8465	3.0	0.12	82.000	3.2283	17.000	0.6693	0.5	0.02	21.500	0.8465
LM104949	JLM104910	50.800	2.0000	22.225	0.8750	3.5	0.14	82.000	3.2283	17.000	0.6693	0.5	0.02	21.500	0.8465
JLM104948	LM104911	50.000	1.9685	21.500	0.8465	3.0	0.12	82.550	3.2500	16.510	0.6500	1.3	0.05	21.116	0.8313
LM104949	LM104911	50.800	2.0000	22.225	0.8750	3.5	0.14	82.550	3.2500	16.510	0.6500	1.3	0.05	21.116	0.8313
M205100 SERIES															
JM205149	JM205110	50.000	1.9685	28.000	1.1024	3.0	0.12	90.000	3.5433	23.000	0.9055	2.5	0.10	28.000	1.1024
JM205149A	JM205110	50.000	1.9685	28.000	1.1024	5.0	0.20	90.000	3.5433	23.000	0.9055	2.5	0.10	28.000	1.1024
M207000 SERIES															
JM207049	JM207010	55.000	2.1654	29.000	1.1417	1.5	0.06	95.000	3.7402	23.500	0.9252	2.5	0.10	29.000	1.1417
JM207049A	JM207010	55.000	2.1654	29.000	1.1417	6.0	0.24	95.000	3.7402	23.500	0.9252	2.5	0.10	29.000	1.1417
JM207049	JM207010A	55.000	2.1654	29.000	1.1417	1.5	0.06	95.000	3.7402	24.500	0.9646	2.0	0.08	30.000	1.1811
JM207049A	JM207010A	55.000	2.1654	29.000	1.1417	6.0	0.24	95.000	3.7402	24.500	0.9646	2.0	0.08	30.000	1.1811
H211700 SERIES															
JH211749	JH211710	65.000	2.5591	38.500	1.5157	3.0	0.12	120.000	4.7244	32.000	1.2598	2.5	0.10	39.000	1.5354
HM212000 SERIES															
HM212044	HM212010	60.325	2.3750	38.354	1.5100	8.0	0.31	122.238	4.8125	29.718	1.1700	1.5	0.06	38.100	1.5000
HM212046	HM212010	63.500	2.5000	38.354	1.5100	3.5	0.14	122.238	4.8125	29.718	1.1700	1.5	0.06	38.100	1.5000
HM212047	HM212010	63.500	2.5000	38.354	1.5100	7.0	0.28	122.238	4.8125	29.718	1.1700	1.5	0.06	38.100	1.5000
HM212049	HM212010	66.675	2.6250	38.354	1.5100	3.5	0.14	122.238	4.8125	29.718	1.1700	1.5	0.06	38.100	1.5000
HM212049X	HM212010	66.675	2.6250	38.354	1.5100	7.0	0.28	122.238	4.8125	29.718	1.1700	1.5	0.06	38.100	1.5000
HM212044	HM212011	60.325	2.3750	38.354	1.5100	8.0	0.31	122.238	4.8125	29.718	1.1700	3.3	0.13	38.100	1.5000
HM212046	HM212011	63.500	2.5000	38.354	1.5100	3.5	0.14	122.238	4.8125	29.718	1.1700	3.3	0.13	38.100	1.5000
HM212047	HM212011	63.500	2.5000	38.354	1.5100	7.0	0.28	122.238	4.8125	29.718	1.1700	3.3	0.13	38.100	1.5000
HM212049	HM212011	66.675	2.6250	38.354	1.5100	3.5	0.14	122.238	4.8125	29.718	1.1700	3.3	0.13	38.100	1.5000
HM212049X	HM212011	66.675	2.6250	38.354	1.5100	7.0	0.28	122.238	4.8125	29.718	1.1700	3.3	0.13	38.100	1.5000
L217800 SERIES															
L217849	L217810	88.900	3.5000	20.638	0.8125	1.5	0.06	123.825	4.8750	16.670	0.6563	1.5	0.06	20.637	0.8125
HM218200 SERIES															
HM218248	HM218210	89.974	3.5423	40.000	1.5748	7.0	0.28	146.975	5.7864	32.500	1.2795	3.5	0.14	40.000	1.5748
HM220100 SERIES															
HM220149	HM220110	99.974	3.9360	42.000	1.6535	8.0	0.31	156.975	6.1801	34.000	1.3386	3.5	0.14	42.000	1.6535
HH221400 SERIES															
HH221449	HH221410	101.600	4.0000	57.531	2.2650	8.0	0.31	190.500	7.5000	46.038	1.8125	3.3	0.13	57.150	2.2500

$$P = X \cdot Fr + Y \cdot Fa$$

$\frac{Fa}{Fr} \leq e$		$\frac{Fa}{Fr} > e$	
X	Y	X	Y
1	0	0.40	See table

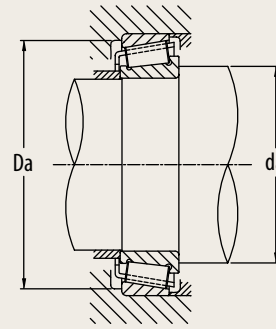

Cone	Cup	Basic Load Rating		a		e	Y Axial Load Factor	Da		da		Reference Speed RPM	Cone Weight Kg	Cup Weight Kg
		Dynamic Cr	Static Cor	Effective Load Center				Housing Bore ID		Shaft OD				
		KN	KN	mm	inch			mm	inch	mm	inch			
LM104900 SERIES														
JLM104948	JLM104910	66.8	88.9	5.4	0.21	0.31	1.97	75	2.95	60	2.36	5000	0.293	0.129
LM104949	JLM104910	66.8	88.9	5.9	0.23	0.31	1.97	75	2.95	61	2.40	5000	0.287	0.129
JLM104948	LM104911	66.8	88.9	5.9	0.23	0.31	1.97	75	2.95	60	2.36	5000	0.293	0.132
LM104949	LM104911	66.8	88.9	5.9	0.23	0.31	1.97	75	2.95	61	2.40	5000	0.287	0.132
M205100 SERIES														
JM205149	JM205110	101	131	7.5	0.30	0.33	1.82	80	3.15	62	2.44	3000	0.508	0.242
JM205149A	JM205110	101	131	7.5	0.30	0.33	1.82	80	3.15	64	2.52	3000	0.502	0.242
M207000 SERIES														
JM207049	JM207010	108	146	7.6	0.30	0.33	1.79	84	3.31	65	2.56	5000	0.569	0.256
JM207049A	JM207010	108	146	7.6	0.30	0.33	1.79	84	3.31	70	2.76	5000	0.554	0.256
JM207049	JM207010A	108	146	7.6	0.30	0.33	1.79	85	3.35	65	2.56	5000	0.569	0.275
JM207049A	JM207010A	108	146	7.6	0.30	0.33	1.79	85	3.35	70	2.76	5000	0.554	0.275
H211700 SERIES														
JH211749	JH211710	185	248	11.1	0.44	0.34	1.78	106	4.17	81	3.19	4400	1.260	0.619
HM212000 SERIES														
HM212044	HM212010	186	243	10.7	0.42	0.34	1.78	110	4.33	84	3.31	4000	1.420	0.600
HM212046	HM212010	186	243	10.7	0.42	0.34	1.78	110	4.33	81	3.19	4000	1.350	0.600
HM212047	HM212010	186	243	10.7	0.42	0.34	1.78	110	4.33	84	3.31	4000	1.330	0.600
HM212049	HM212010	186	243	10.7	0.42	0.34	1.78	110	4.33	91	3.58	4000	1.250	0.600
HM212049X	HM212010	186	243	10.7	0.42	0.34	1.78	110	4.33	85	3.35	4000	1.230	0.600
HM212044	HM212011	186	243	10.7	0.42	0.34	1.78	109	4.29	84	3.31	4000	1.420	0.590
HM212046	HM212011	186	243	10.7	0.42	0.34	1.78	109	4.29	81	3.19	4000	1.350	0.590
HM212047	HM212011	186	243	10.7	0.42	0.34	1.78	109	4.29	84	3.31	4000	1.330	0.590
HM212049	HM212011	186	243	10.7	0.42	0.34	1.78	109	4.29	91	3.58	4000	1.250	0.590
HM212049X	HM212011	186	243	10.7	0.42	0.34	1.78	109	4.29	85	3.35	4000	1.230	0.590
L217800 SERIES														
L217849	L217810	78.2	137	-0.1	0.00	0.33	1.82	116	4.57	101	3.98	3000	0.477	0.238
HM218200 SERIES														
HM218248	HM218210	224	335	9.3	0.37	0.33	1.80	133	5.24	109	4.29	3300	1.730	0.782
HM220100 SERIES														
HM220149	HM220110	242	385	9.6	0.38	0.33	1.80	142	5.59	122	4.80	3000	2.000	0.861
HH221400 SERIES														
HH221449	HH221410	447	616	15.0	0.59	0.33	1.79	171	6.73	128	5.04	2500	4.710	2.220

INCH SERIES

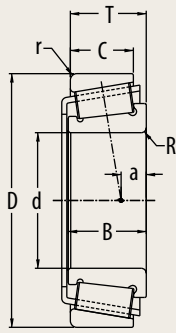

The tables include the most common industry series and sizes in the market. Additional industry series and sizes are available from PEER upon request.

Cone	Cup	d		B		R		D		C		r		T	
		Cone Bore		Cone Width		Max Shaft Radius		Cup Outer Diameter		Cup Width		Max Housing Radius		Total Width	
		mm	inch	mm	inch	mm	inch	mm	inch	mm	inch	mm	inch	mm	inch
LM300800 SERIES															
LM300849	LM300811	40.988	1.6137	18.000	0.7087	SP	SP	67.975	2.6762	13.500	0.5315	1.5	0.06	17.502	0.6891
L305600 SERIES															
L305649	L305610	50.800	2.0000	18.258	0.7188	1.5	0.06	80.962	3.1875	14.288	0.5625	1.5	0.06	18.257	0.7188
H307700 SERIES															
JH307749	JH307710	55.000	2.1654	39.000	1.5354	3.0	0.12	110.000	4.3307	32.000	1.2598	2.5	0.10	39.000	1.5354
LM501300 SERIES															
LM501349	LM501310	41.275	1.6250	19.812	0.7800	3.5	0.14	73.431	2.8910	14.732	0.5800	0.8	0.03	19.558	0.7700
LM503300 SERIES															
LM503349	LM503310	45.987	1.8105	18.000	0.7087	2.3	0.09	74.976	2.9518	14.000	0.5512	1.5	0.06	18.000	0.7087
LM503349A	LM503310	45.987	1.8105	18.000	0.7087	SP	SP	74.976	2.9518	14.000	0.5512	1.5	0.06	18.000	0.7087
HH506300 SERIES															
HH506348	HH506310	49.212	1.9375	44.450	1.7500	3.5	0.14	114.300	4.5000	36.068	1.4200	3.3	0.13	44.450	1.7500
LM506800 SERIES															
JLM506849	JLM506810	55.000	2.1654	23.000	0.9055	1.5	0.06	90.000	3.5433	18.500	0.7283	0.5	0.02	23.000	0.9055
LM508700 SERIES															
JLM508748	JLM508710	60.000	2.3622	24.000	0.9449	5.0	0.20	95.000	3.7402	19.000	0.7480	2.5	0.10	24.000	0.9449
M511900 SERIES															
JM511945	JM511910	65.000	2.5591	30.000	1.1811	3.0	0.12	110.000	4.3307	22.500	0.8858	2.5	0.10	28.000	1.1024
JM511946	JM511910	65.000	2.5591	28.000	1.1024	3.0	0.12	110.000	4.3307	22.500	0.8858	2.5	0.10	28.000	1.1024
HMS16400 SERIES															
HMS16448	HMS16410	82.550	3.2500	39.688	1.5625	6.8	0.27	133.350	5.2500	32.545	1.2813	3.3	0.13	39.687	1.5625
HMS16449A	HMS16410	82.550	3.2500	39.688	1.5625	6.2	0.24	133.350	5.2500	32.545	1.2813	3.3	0.13	39.687	1.5625
HMS16449C	HMS16410	82.550	3.2500	39.688	1.5625	3.5	0.14	133.350	5.2500	32.545	1.2813	3.3	0.13	39.687	1.5625
HMS16448	HMS16414-B	82.550	3.2500	39.688	1.5625	6.8	0.27	136.525	5.3750	32.545	1.2813	1.5	0.06	39.687	1.5625
HMS16449A	HMS16414-B	82.550	3.2500	39.688	1.5625	6.2	0.24	136.525	5.3750	32.545	1.2813	1.5	0.06	39.687	1.5625
HMS16449C	HMS16414-B	82.550	3.2500	39.688	1.5625	3.5	0.14	136.525	5.3750	32.545	1.2813	1.5	0.06	39.687	1.5625
HMS16800 SERIES															
JHM516849	JHM516810	85.000	3.3465	38.000	1.4961	3.0	0.12	140.000	5.5118	31.500	1.2402	2.5	0.10	39.000	1.5354
HMS18400 SERIES															
HMS18445	HMS18410	88.900	3.5000	39.688	1.5625	6.4	0.25	152.400	6.0000	30.162	1.1875	3.3	0.13	39.688	1.5625
HMS22600 SERIES															
JHM522649A	JHM522610	110.000	4.3307	46.000	1.8110	3.0	0.12	180.000	7.0866	38.000	1.4961	2.5	0.10	47.000	1.8504

$$P = X \cdot Fr + Y \cdot Fa$$

$\frac{Fa}{Fr} \leq e$		$\frac{Fa}{Fr} > e$	
X	Y	X	Y
1	0	0.40	See table

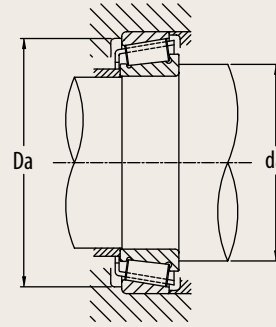

Cone	Cup	Basic Load Rating		a		e	Y Axial Load Factor	Da		da		Reference Speed RPM	Cone Weight Kg	Cup Weight Kg
		Dynamic Cr	Static Cor	Effective Load Center				Housing Bore ID		Shaft OD				
		KN	KN	mm	inch			mm	inch	mm	inch			
LM300800 SERIES														
LM300849	LM300811	42	59.8	3.6	0.14	0.35	1.72	61	2.40	51	2.01	6000	0.155	0.081
L305600 SERIES														
L305649	L305610	51.7	76.4	2.3	0.09	0.36	1.69	73	2.87	59	2.32	4500	0.227	0.119
H307700 SERIES														
JH307749	JH307710	172	218	12.0	0.47	0.35	1.73	96	3.78	71	2.80	5000	1.120	0.561
LM501300 SERIES														
LM501349	LMS01310	52.4	63.8	3.2	0.13	0.40	1.50	66	2.60	52	2.05	6000	0.223	0.108
LM503300 SERIES														
LM503349	LMS03310	50.4	70	2.2	0.09	0.40	1.49	67	2.64	55	2.17	5000	0.204	0.095
LM503349A	LMS03310	50.4	70	2.2	0.09	0.40	1.49	67	2.64	57	2.24	5000	0.201	0.095
HH506300 SERIES														
HH506348	HH506310	205	254	13.9	0.55	0.40	1.49	98	3.86	69	2.72	5000	1.500	0.673
LM506800 SERIES														
JLM506849	JLM506810	77.9	108	2.9	0.11	0.40	1.49	82	3.23	65	2.56	4500	0.369	0.184
LM508700 SERIES														
JLM508748	JLM508710	82.5	118	2.8	0.11	0.40	1.49	85	3.35	73	2.87	4500	0.395	0.196
MS11900 SERIES														
JM511945	JMS11910	115	165	3.3	0.13	0.40	1.49	98	3.86	78	3.07	4000	0.722	0.337
JM511946	JMS11910	115	165	3.3	0.13	0.40	1.49	98	3.86	78	3.07	4000	0.741	0.337
HMS16400 SERIES														
HMS16448	HMS16410	181	315	7.6	0.30	0.40	1.49	118	4.65	102	4.02	3600	1.350	0.761
HMS16449A	HMS16410	181	315	7.6	0.30	0.40	1.49	118	4.65	102	4.02	3600	1.350	0.761
HMS16449C	HMS16410	181	315	7.6	0.30	0.40	1.49	118	4.65	99	3.90	3600	1.370	0.761
HMS16448	HMS16414-B	181	315	7.6	0.30	0.40	1.49	120	4.72	102	4.02	3600	1.350	0.773
HMS16449A	HMS16414-B	181	315	7.6	0.30	0.40	1.49	120	4.72	102	4.02	3600	1.350	0.773
HMS16449C	HMS16414-B	181	315	7.6	0.30	0.40	1.49	120	4.72	99	3.90	3600	1.370	0.773
HMS16800 SERIES														
JHM516849	JHM516810	197	295	6.2	0.24	0.41	1.47	126	4.96	100	3.94	3500	0.833	0.761
HMS18400 SERIES														
HMS18445	HMS18410	248	354	6.2	0.24	0.40	1.49	138	5.43	110	4.33	3000	2.070	0.764
HMS22600 SERIES														
JHM522649A	JHM522610	305	481	6.2	0.24	0.41	1.48	163	6.42	134	5.28	2800	2.930	1.500

INCH SERIES

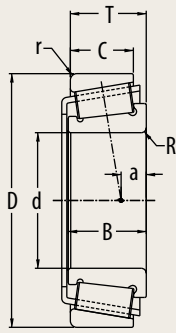

The tables include the most common industry series and sizes in the market. Additional industry series and sizes are available from PEER upon request.

Cone	Cup	d		B		R		D		C		r		T	
		Cone Bore		Cone Width		Max Shaft Radius		Cup Outer Diameter		Cup Width		Max Housing Radius		Total Width	
		mm	inch	mm	inch	mm	inch	mm	inch	mm	inch	mm	inch	mm	inch
LM603000 SERIES															
LM603049	LM603011	45.242	1.7812	19.842	0.7812	3.5	0.14	77.788	3.0625	15.080	0.5937	0.8	0.03	19.842	0.7812
LM603049	LM603012	45.242	1.7812	19.842	0.7812	3.5	0.14	77.788	3.0625	16.667	0.6562	0.8	0.03	21.430	0.8437
HM617000 SERIES															
HM617049	HM617010	85.725	3.3750	42.862	1.6875	4.8	0.19	142.138	5.5960	34.133	1.3438	3.3	0.13	42.863	1.6875
LM704600 SERIES															
JLM704649	JLM704610	50.000	1.9685	22.000	0.8661	3.5	0.14	84.000	3.3071	17.500	0.6890	1.5	0.06	22.000	0.8661
LM710900 SERIES															
JLM710949	JLM710910	65.000	2.5591	23.000	0.9055	3.0	0.12	105.000	4.1339	18.500	0.7283	1.0	0.04	24.000	0.9449
LM714100 SERIES															
JLM714149	JLM714110	75.000	2.9528	25.000	0.9843	3.0	0.12	115.000	4.5276	19.000	0.7480	2.5	0.10	25.000	0.9843
M714200 SERIES															
JM714249	JM714210	75.000	2.9528	29.500	1.1614	3.0	0.12	120.000	4.7244	25.000	0.9843	2.5	0.10	31.000	1.2205
H715300 SERIES															
H715334	H715311	61.912	2.4375	46.038	1.8125	3.5	0.14	136.525	5.3750	36.512	1.4375	3.3	0.13	46.038	1.8125
H715343	H715311	68.262	2.6875	46.038	1.8125	3.5	0.14	136.525	5.3750	36.512	1.4375	3.3	0.13	46.038	1.8125
H715345	H715311	71.438	2.8125	46.038	1.8125	3.5	0.14	136.525	5.3750	36.512	1.4375	3.3	0.13	46.038	1.8125
H715334	H715313W	61.912	2.4375	46.038	1.8125	3.5	0.14	136.525	5.3750	39.688	1.5625	3.3	0.13	49.213	1.9375
H715343	H715313W	68.262	2.6875	46.038	1.8125	3.5	0.14	136.525	5.3750	39.688	1.5625	3.3	0.13	49.213	1.9375
H715345	H715313W	71.438	2.8125	46.038	1.8125	3.5	0.14	136.525	5.3750	39.688	1.5625	3.3	0.13	49.213	1.9375
M716600 SERIES															
JM716649	JM716610	85.000	3.3465	29.000	1.1417	3.0	0.12	130.000	5.1181	24.000	0.9449	2.5	0.10	30.000	1.1811
M718100 SERIES															
JM718149	JM718110	90.000	3.5433	34.000	1.3386	3.0	0.12	140.000	5.5118	27.000	1.0630	2.5	0.10	35.000	1.3780
M719100 SERIES															
JM719149	JM719113	95.000	3.7402	34.000	1.3386	3.0	0.12	150.000	5.9055	27.000	1.0630	2.5	0.10	35.000	1.3780
HM720200 SERIES															
JHM720249	JHM720210	100.000	3.9370	40.000	1.5748	3.0	0.12	160.000	6.2992	32.000	1.2598	2.5	0.10	41.000	1.6142
M738200 SERIES															
JM738249	JM738210	190.000	7.4803	44.000	1.7323	3.0	0.12	260.000	10.2362	36.500	1.4370	2.5	0.10	46.000	1.8110
HM801300 SERIES															
HM801346	HM801310	41.275	1.6250	28.575	1.1250	0.8	0.03	82.550	3.2500	23.020	0.9063	3.3	0.13	29.370	1.1563
M802000 SERIES															
M802048	M802011	41.275	1.6250	25.654	1.0100	3.5	0.14	82.550	3.2500	20.193	0.7950	3.3	0.13	26.543	1.0450

$$P = X \cdot Fr + Y \cdot Fa$$

$\frac{Fa}{Fr} \leq e$		$\frac{Fa}{Fr} > e$	
X	Y	X	Y
1	0	0.40	See table

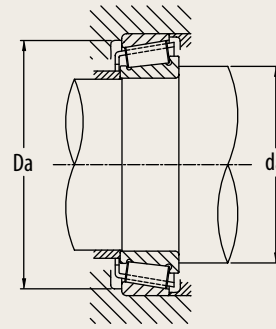

Cone	Cup	Basic Load Rating		a		e	Y Axial Load Factor	Da		da		Reference Speed RPM	Cone Weight Kg	Cup Weight Kg
		Dynamic Cr	Static Cor	Effective Load Center				Housing Bore ID		Shaft OD				
		KN	KN	mm	inch			mm	inch	mm	inch			
LM603000 SERIES														
LM603049	LM603011	53.8	67.7	2.4	0.09	0.43	1.41	70	2.76	56	2.20	5500	0.234	0.121
LM603049	LM603012	53.8	67.7	2.4	0.09	0.43	1.41	70	2.76	56	2.20	5500	0.234	0.140
HM617000 SERIES														
HM617049	HM617010	214	338	7.7	0.30	0.43	1.39	126	4.96	104	4.09	3500	1.680	0.901
LM704600 SERIES														
JLM704649	JLM704610	67	90	2.5	0.10	0.44	1.37	75	2.95	61	2.40	5000	0.304	0.160
LM710900 SERIES														
JLM710949	JLM710910	90.7	122	0.1	0.00	0.45	1.32	96	3.78	77	3.03	4000	0.512	0.235
LM714100 SERIES														
JLM714149	JLM714110	97.7	143	-0.5	-0.02	0.46	1.31	104	4.09	87	3.43	3000	0.607	0.268
M714200 SERIES														
JM714249	JM714210	141	206	3.1	0.12	0.44	1.35	107	4.21	88	3.46	3800	0.840	0.431
H715300 SERIES														
H715334	H715311	226	356	9.0	0.35	0.47	1.27	119	4.69	89	3.50	3500	2.500	0.950
H715343	H715311	226	356	9.0	0.35	0.47	1.27	119	4.69	92	3.62	3500	2.270	0.950
H715345	H715311	226	356	9.0	0.35	0.47	1.27	119	4.69	93	3.66	3500	2.140	0.950
H715334	H715313W	226	356	9.0	0.35	0.47	1.27	118	4.65	89	3.50	3500	2.500	1.090
H715343	H715313W	226	356	9.0	0.35	0.47	1.27	118	4.65	92	3.62	3500	2.270	1.090
H715345	H715313W	226	356	9.0	0.35	0.47	1.27	118	4.65	93	3.66	3500	2.140	1.090
M716600 SERIES														
JM716649	JM716610	135	215	0.3	0.01	0.44	1.35	117	4.61	99	3.90	3000	0.907	0.456
M718100 SERIES														
JM718149	JM718110	188	277	2.3	0.09	0.44	1.35	131	5.16	106	4.17	3000	1.380	0.653
M719100 SERIES														
JM719149	JM719113	179	277	1.6	0.06	0.44	1.36	134	5.28	110	4.33	3000	1.380	0.767
HM720200 SERIES														
JHM720249	JHM720210	232	364	2.7	0.11	0.47	1.28	144	5.67	118	4.65	3000	2.030	0.966
M738200 SERIES														
JM738249	JM738210	359	699	-11.0	-0.43	0.48	1.26	242	9.53	211	8.31	1600	4.480	2.190
HM801300 SERIES														
HM801346	HM801310	84.8	112	5.1	0.20	0.55	1.10	68	2.68	51	2.01	6500	0.469	0.277
M802000 SERIES														
M802048	M802011	76.3	95	3.7	0.15	0.55	1.10	69	2.72	55	2.17	6500	0.402	0.225

INCH SERIES

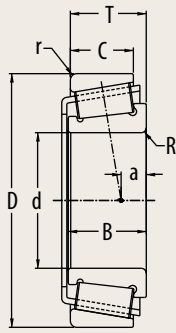

The tables include the most common industry series and sizes in the market. Additional industry series and sizes are available from PEER upon request.

Cone	Cup	d		B		R		D		C		r		T	
		Cone Bore		Cone Width		Max Shaft Radius		Cup Outer Diameter		Cup Width		Max Housing Radius		Total Width	
		mm	inch	mm	inch	mm	inch	mm	inch	mm	inch	mm	inch	mm	inch
HM803100 SERIES															
HM803145	HM803110	41.275	1.6250	29.370	1.1563	0.8	0.03	88.900	3.5000	23.020	0.9063	3.3	0.13	30.162	1.1875
HM803146	HM803110	41.275	1.6250	29.370	1.1563	3.5	0.14	88.900	3.5000	23.020	0.9063	3.3	0.13	30.162	1.1875
HM803149	HM803110	44.450	1.7500	29.370	1.1563	3.5	0.14	88.900	3.5000	23.020	0.9063	3.3	0.13	30.162	1.1875
M804000 SERIES															
M804048	M804010	47.625	1.8750	25.400	1.0000	0.8	0.03	88.900	3.5000	19.050	0.7500	3.3	0.13	25.400	1.0000
M804049	M804010	47.625	1.8750	25.400	1.0000	3.5	0.14	88.900	3.5000	19.050	0.7500	3.3	0.13	25.400	1.0000
HM804800 SERIES															
HM804840	HM804810	41.275	1.6250	29.370	1.1563	3.5	0.14	95.250	3.7500	23.020	0.9063	3.3	0.13	30.162	1.1875
HM804846	HM804810	47.625	1.8750	29.370	1.1563	3.5	0.14	95.250	3.7500	23.020	0.9063	3.3	0.13	30.162	1.1875
HM804848	HM804810	48.412	1.9060	29.370	1.1563	2.3	0.09	95.250	3.7500	23.020	0.9063	3.3	0.13	30.162	1.1875
LM806600 SERIES															
LM806649	LM806610	53.975	2.1250	19.050	0.7500	2.3	0.09	88.900	3.5000	13.492	0.5312	2.0	0.08	19.050	0.7500
HM807000 SERIES															
HM807035	HM807010	41.275	1.6250	36.512	1.4375	1.5	0.06	104.775	4.1250	28.575	1.1250	3.3	0.13	36.512	1.4375
HM807040	HM807010	44.450	1.7500	36.512	1.4375	3.5	0.14	104.775	4.1250	28.575	1.1250	3.3	0.13	36.512	1.4375
HM807044	HM807010	49.212	1.9375	36.512	1.4375	3.5	0.14	104.775	4.1250	28.575	1.1250	3.3	0.13	36.512	1.4375
HM807046	HM807010	50.800	2.0000	36.512	1.4375	3.5	0.14	104.775	4.1250	28.575	1.1250	3.3	0.13	36.512	1.4375
HM807049	HM807010	53.975	2.1250	36.512	1.4375	3.5	0.14	104.775	4.1250	28.575	1.1250	3.3	0.13	36.512	1.4375
JHM807045	HM807010	50.000	1.9685	36.000	1.4173	3.0	0.12	104.775	4.1250	28.575	1.1250	3.3	0.13	36.639	1.4425
HM807035	JHM807012	41.275	1.6250	36.512	1.4375	1.5	0.06	105.000	4.1339	29.000	1.1417	2.5	0.10	36.873	1.4517
HM807040	JHM807012	44.450	1.7500	36.512	1.4375	3.5	0.14	105.000	4.1339	29.000	1.1417	2.5	0.10	36.873	1.4517
HM807044	JHM807012	49.212	1.9375	36.512	1.4375	3.5	0.14	105.000	4.1339	29.000	1.1417	2.5	0.10	36.873	1.4517
HM807046	JHM807012	50.800	2.0000	36.512	1.4375	3.5	0.14	105.000	4.1339	29.000	1.1417	2.5	0.10	36.873	1.4517
HM807049	JHM807012	53.975	2.1250	36.512	1.4375	3.5	0.14	105.000	4.1339	29.000	1.1417	2.5	0.10	36.873	1.4517
JHM807045	JHM807012	50.000	1.9685	36.000	1.4173	3.0	0.12	105.000	4.1339	29.000	1.1417	2.5	0.10	37.000	1.4567
LM81300 SERIES															
JLM813049	JLM813010	70.000	2.7559	25.000	0.9843	1.0	0.04	110.000	4.3307	20.500	0.8071	2.5	0.10	26.000	1.0236
HM813800 SERIES															
HM813840	HM813810	55.562	2.1875	36.512	1.4375	3.5	0.14	127.000	5.0000	26.988	1.0625	3.3	0.13	36.512	1.4375
HM813841	HM813810	60.325	2.3750	36.512	1.4375	3.5	0.14	127.000	5.0000	26.988	1.0625	3.3	0.13	36.512	1.4375
HM813844	HM813810	66.675	2.6250	36.512	1.4375	3.5	0.14	127.000	5.0000	26.988	1.0625	3.3	0.13	36.512	1.4375
LM814800 SERIES															
LM814849	LM814810	77.788	3.0625	25.400	1.0000	3.5	0.14	117.475	4.6250	19.050	0.7500	3.3	0.13	25.400	1.0000

$$P = X \cdot F_r + Y \cdot F_a$$

$\frac{F_a}{F_r} \leq e$		$\frac{F_a}{F_r} > e$	
X	Y	X	Y
1	0	0.40	See table

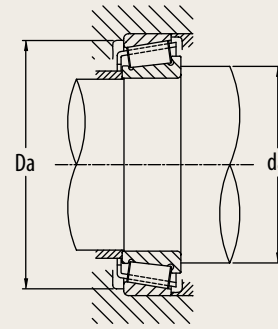

Cone	Cup	Basic Load Rating		a		e	Y	Da		da		Reference Speed RPM	Cone Weight Kg	Cup Weight Kg	
		Dynamic Cr	Static Cor	Effective Load Center				Axial Load Factor	Housing Bore ID		Shaft OD				
		KN	KN	mm	inch				mm	inch	mm				inch
HM803100 SERIES															
HM803145	HM803110	97.2	131	4.4	0.17	0.55	1.10	74	2.91	55	2.17	5500	0.594	0.316	
HM803146	HM803110	97.2	131	4.4	0.17	0.55	1.10	74	2.91	58	2.28	5500	0.590	0.316	
HM803149	HM803110	97.2	131	4.4	0.17	0.55	1.10	74	2.91	59	2.32	5500	0.541	0.316	
M804000 SERIES															
M804048	M804010	82.8	103	1.7	0.07	0.55	1.10	76	2.99	58	2.28	5500	0.450	0.213	
M804049	M804010	82.8	103	1.7	0.07	0.55	1.10	76	2.99	61	2.40	5500	0.445	0.213	
HM804800 SERIES															
HM804840	HM804810	107	145	3.8	0.15	0.55	1.10	80	3.15	60	2.36	5000	0.715	0.348	
HM804846	HM804810	107	145	3.8	0.15	0.55	1.10	80	3.15	63	2.48	5000	0.613	0.348	
HM804848	HM804810	107	145	3.8	0.15	0.55	1.10	80	3.15	62	2.44	5000	0.602	0.348	
LM806600 SERIES															
LM806649	LM806610	58.3	78.1	-2.3	-0.09	0.55	1.10	79	3.11	65	2.56	4500	0.301	0.134	
HM807000 SERIES															
HM807035	HM807010	151	210	7.8	0.31	0.49	1.23	89	3.50	61	2.40	4500	1.200	0.495	
HM807040	HM807010	151	210	7.8	0.31	0.49	1.23	89	3.50	65	2.56	4500	1.140	0.495	
HM807044	HM807010	151	210	7.8	0.31	0.49	1.23	89	3.50	67	2.64	4500	1.040	0.495	
HM807046	HM807010	151	210	7.8	0.31	0.49	1.23	89	3.50	68	2.68	4500	1.000	0.495	
HM807049	HM807010	151	210	7.8	0.31	0.49	1.23	89	3.50	70	2.76	4500	0.926	0.495	
JHM807045	HM807010	151	210	7.9	0.31	0.49	1.23	89	3.50	67	2.64	4500	1.020	0.495	
HM807035	JHM807012	151	210	7.8	0.31	0.49	1.23	90	3.54	61	2.40	4500	1.200	0.518	
HM807040	JHM807012	151	210	7.8	0.31	0.49	1.23	90	3.54	65	2.56	4500	1.140	0.518	
HM807044	JHM807012	151	210	7.8	0.31	0.49	1.23	90	3.54	67	2.64	4500	1.040	0.518	
HM807046	JHM807012	151	210	7.8	0.31	0.49	1.23	90	3.54	68	2.68	4500	1.000	0.518	
HM807049	JHM807012	151	210	7.8	0.31	0.49	1.23	90	3.54	70	2.76	4500	0.926	0.518	
JHM807045	JHM807012	151	210	7.9	0.31	0.49	1.23	90	3.54	67	2.64	4500	1.020	0.518	
LM81300 SERIES															
JLM813049	JLM813010	98.7	149	-0.2	-0.01	0.49	1.23	98	3.86	81	3.19	4000	0.564	0.300	
HM813800 SERIES															
HM813840	HM813810	161	225	3.7	0.15	0.50	1.20	111	4.37	80	3.15	3800	1.670	0.615	
HM813841	HM813810	161	225	3.7	0.15	0.50	1.20	111	4.37	83	3.27	3800	1.540	0.615	
HM813844	HM813810	161	225	3.7	0.15	0.50	1.20	111	4.37	86	3.39	3800	1.360	0.615	
LM814800 SERIES															
LM814849	LM814810	97.1	156	-2.2	-0.09	0.51	1.18	105	4.13	91	3.58	3500	0.643	0.291	

INCH SERIES

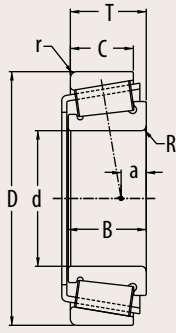

The tables include the most common industry series and sizes in the market. Additional industry series and sizes are available from PEER upon request.

Cone	Cup	d		B		R		D		C		r		T	
		Cone Bore		Cone Width		Max Shaft Radius		Cup Outer Diameter		Cup Width		Max Housing Radius		Total Width	
		mm	inch	mm	inch	mm	inch	mm	inch	mm	inch	mm	inch	mm	inch
L819300 SERIES															
JL819349	JL819310	95.000	3.7402	20.000	0.7874	5.0	0.20	135.000	5.3150	14.000	0.5512	2.5	0.10	20.000	0.7874
M822000 SERIES															
JM822049	JM822010	110.000	4.3307	35.000	1.3780	3.0	0.12	165.000	6.4961	26.500	1.0433	2.5	0.10	35.000	1.3780
HM903200 SERIES															
HM903249	HM903210	44.450	1.7500	28.575	1.1250	3.5	0.14	95.250	3.7500	22.225	0.8750	0.8	0.03	30.958	1.2188

$$P = X \cdot Fr + Y \cdot Fa$$

$\frac{Fa}{Fr} \leq e$		$\frac{Fa}{Fr} > e$	
X	Y	X	Y
1	0	0.40	See table

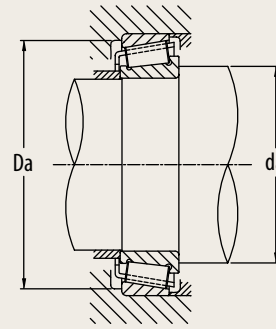

Cone	Cup	Basic Load Rating		a		e	Y Axial Load Factor	Da		da		Reference Speed RPM	Cone Weight Kg	Cup Weight Kg
		Dynamic Cr	Static Cor	Effective Load Center				Housing Bore ID		Shaft OD				
		KN	KN	mm	inch			mm	inch	mm	inch			
L819300 SERIES														
JL819349	JL819310	76.3	132	-10.9	-0.43	0.58	1.03	123	4.84	110	4.33	2500	0.601	0.264
M822000 SERIES														
JM822049	JM822010	201	336	-3.1	-0.12	0.50	1.21	150	5.91	126	4.96	2500	1.690	0.828
HM903200 SERIES														
HM903249	HM903210	97.8	119	-0.5	-0.02	0.74	0.81	80	3.15	61	2.40	6000	0.609	0.387

ISO METRIC SERIES

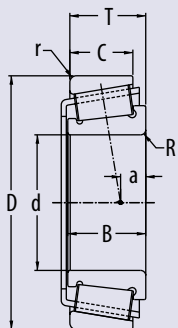

The tables include the most common industry series and sizes in the market. Additional industry series and sizes are available from PEER upon request.

Cone	Cup	d		B		R		D		C		r		T	
		Cone Bore		Cone Width		Max Shaft Radius		Cup Outer Diameter		Cup Width		Max Housing Radius		Total Width	
		mm	inch	mm	inch	mm	inch	mm	inch	mm	inch	mm	inch	mm	inch
X30203	Y30203	17.000	0.6693	12.000	0.4724	1.0	0.04	40.000	1.5748	11.000	0.4331	1.0	0.04	13.250	0.5217
X30204	Y30204	20.000	0.7874	14.000	0.5512	1.0	0.04	47.000	1.8504	12.000	0.4724	1.0	0.04	15.250	0.6004
X30205	Y30205	25.000	0.9843	15.000	0.5906	1.0	0.04	52.000	2.0472	13.000	0.5118	1.0	0.04	16.250	0.6398
X30206	Y30206	30.000	1.1811	16.000	0.6299	1.0	0.04	62.000	2.4409	14.000	0.5512	1.0	0.04	17.250	0.6791
X30207	Y30207	35.000	1.3780	17.000	0.6693	1.5	0.06	72.000	2.8346	15.000	0.5906	1.5	0.06	18.250	0.7185
X30208	Y30208	40.000	1.5748	18.000	0.7087	1.5	0.06	80.000	3.1496	16.000	0.6299	1.5	0.06	19.750	0.7776
X30209	Y30209	45.000	1.7717	19.000	0.7480	1.5	0.06	85.000	3.3465	16.000	0.6299	1.5	0.06	20.750	0.8169
X30210	Y30210	50.000	1.9685	20.000	0.7874	1.5	0.06	90.000	3.5433	17.000	0.6693	1.5	0.06	21.750	0.8563
X30211	Y30211	55.000	2.1654	21.000	0.8268	2.0	0.08	100.000	3.9370	18.000	0.7087	1.5	0.06	22.750	0.8957
X30212	Y30212	60.000	2.3622	22.000	0.8661	2.0	0.08	110.000	4.3307	19.000	0.7480	1.5	0.06	23.750	0.9350
X30213	Y30213	65.000	2.5591	23.000	0.9055	2.0	0.08	120.000	4.7244	20.000	0.7874	1.5	0.06	24.750	0.9744
X30214	Y30214	70.000	2.7559	24.000	0.9449	2.0	0.08	125.000	4.9213	21.000	0.8268	1.5	0.06	26.250	1.0335
X30215	Y30215	75.000	2.9528	25.000	0.9843	2.0	0.08	130.000	5.1181	22.000	0.8661	1.5	0.06	27.250	1.0728
X30216	Y30216	80.000	3.1496	26.000	1.0236	2.5	0.10	140.000	5.5118	22.000	0.8661	2.0	0.08	28.250	1.1122
X30217	Y30217	85.000	3.3465	28.000	1.1024	2.5	0.10	150.000	5.9055	24.000	0.9449	2.0	0.08	30.500	1.2008
X30218	Y30218	90.000	3.5433	30.000	1.1811	2.5	0.10	160.000	6.2992	26.000	1.0236	2.0	0.08	32.500	1.2795
X30219	Y30219	95.000	3.7402	32.000	1.2598	3.0	0.12	170.000	6.6929	27.000	1.0630	2.5	0.10	34.500	1.3583
X30220	Y30220	100.000	3.9370	34.000	1.3386	3.0	0.12	180.000	7.0866	29.000	1.1417	2.5	0.10	37.000	1.4567
X30221	Y30221	105.000	4.1339	36.000	1.4173	3.0	0.12	190.000	7.4803	30.000	1.1811	2.5	0.10	39.000	1.5354
X30222	Y30222	110.000	4.3307	38.000	1.4961	3.0	0.12	200.000	7.8740	32.000	1.2598	2.5	0.10	41.000	1.6142
X30224	Y30224	120.000	4.7244	40.000	1.5748	3.0	0.12	215.000	8.4646	34.000	1.3386	2.5	0.10	43.500	1.7126
X30226	Y30226	130.000	5.1181	40.000	1.5748	4.0	0.16	230.000	9.0551	34.000	1.3386	3.0	0.12	43.750	1.7224
X30302	Y30302	15.000	0.5906	13.000	0.5118	1.0	0.04	42.000	1.6535	11.000	0.4331	1.0	0.04	14.250	0.5610
X30303	Y30303	17.000	0.6693	14.000	0.5512	1.0	0.04	47.000	1.8504	12.000	0.4724	1.0	0.04	15.250	0.6004
X30304	Y30304	20.000	0.7874	15.000	0.5906	1.5	0.06	52.000	2.0472	13.000	0.5118	1.5	0.06	16.250	0.6398
X30305	Y30305	25.000	0.9843	17.000	0.6693	1.5	0.06	62.000	2.4409	15.000	0.5906	1.5	0.06	18.250	0.7185
X30306	Y30306	30.000	1.1811	19.000	0.7480	1.5	0.06	72.000	2.8346	16.000	0.6299	1.5	0.06	20.750	0.8169
X30307	Y30307	35.000	1.3780	21.000	0.8268	2.0	0.08	80.000	3.1496	18.000	0.7087	1.5	0.06	22.750	0.8957
X30308	Y30308	40.000	1.5748	23.000	0.9055	2.0	0.08	90.000	3.5433	20.000	0.7874	1.5	0.06	25.250	0.9941
X30309	Y30309	45.000	1.7717	25.000	0.9843	2.0	0.08	100.000	3.9370	22.000	0.8661	1.5	0.06	27.250	1.0728
X30310	Y30310	50.000	1.9685	27.000	1.0630	2.5	0.10	110.000	4.3307	23.000	0.9055	2.0	0.08	29.250	1.1516
X30311	Y30311	55.000	2.1654	29.000	1.1417	2.5	0.10	120.000	4.7244	25.000	0.9843	2.0	0.08	31.500	1.2402
X30312	Y30312	60.000	2.3622	31.000	1.2205	3.0	0.12	130.000	5.1181	26.000	1.0236	2.5	0.10	33.500	1.3189
X30313	Y30313	65.000	2.5591	33.000	1.2992	3.0	0.12	140.000	5.5118	28.000	1.1024	2.5	0.10	36.000	1.4173

$$P = X \cdot Fr + Y \cdot Fa$$

$\frac{Fa}{Fr} \leq e$		$\frac{Fa}{Fr} > e$	
X	Y	X	Y
1	0	0.40	See table

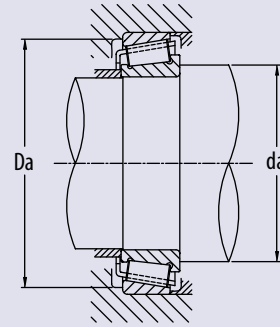

Cone	Cup	Basic Load Rating		a		e	Y Axial Load Factor	Da		da		Reference Speed RPM	Cone Weight Kg	Cup Weight Kg
		Dynamic Cr	Static Cor	Effective Load Center				Housing Bore ID		Shaft OD				
		KN	KN	mm	inch			mm	inch	mm	inch			
X30203	Y30203	19.5	19.1	3.3	0.13	0.35	1.74	35	1.38	23	0.91	11000	0.051	0.030
X30204	Y30204	27.5	27.9	4.1	0.16	0.35	1.74	41	1.61	27	1.06	10000	0.082	0.044
X30205	Y30205	31.6	34	3.7	0.15	0.37	1.60	46	1.79	32	1.26	9000	0.096	0.058
X30206	Y30206	42	45.7	3.4	0.13	0.37	1.60	55	2.17	38	1.50	7500	0.148	0.083
X30207	Y30207	52.9	57.9	2.9	0.11	0.37	1.60	64	2.52	45	1.77	6000	0.218	0.114
X30208	Y30208	62.6	69	2.9	0.11	0.37	1.60	71	2.80	50	1.97	5800	0.273	0.148
X30209	Y30209	67.7	78.3	2.2	0.09	0.40	1.48	76	2.99	55	2.17	5400	0.316	0.158
X30210	Y30210	73	86.4	1.8	0.07	0.42	1.43	81	3.19	60	2.36	5300	0.356	0.177
X30211	Y30211	88.7	104	1.7	0.07	0.40	1.48	90	3.54	66	2.60	4600	0.491	0.225
X30212	Y30212	99.5	117	1.5	0.06	0.40	1.48	99	3.90	72	2.83	4300	0.600	0.310
X30213	Y30213	118	140	0.9	0.04	0.40	1.48	109	4.29	79	3.11	3800	0.785	0.349
X30214	Y30214	125	152	0.4	0.02	0.42	1.43	113	4.45	84	3.31	3700	0.841	0.403
X30215	Y30215	137	172	0.1	0.00	0.44	1.38	118	4.65	89	3.50	3500	0.931	0.435
X30216	Y30216	158	198	0.2	0.01	0.42	1.43	127	5.00	95	3.74	3300	1.160	0.517
X30217	Y30217	176	221	0.2	0.01	0.42	1.43	135	5.31	101	3.98	3200	1.380	0.683
X30218	Y30218	203	259	0.2	0.01	0.42	1.43	145	5.71	107	4.21	3000	1.700	0.848
X30219	Y30219	230	298	0.3	0.01	0.42	1.43	154	6.06	114	4.49	2800	2.050	0.998
X30220	Y30220	259	339	0.6	0.02	0.42	1.43	163	6.42	120	4.72	2700	1.010	1.230
X30221	Y30221	291	386	0.5	0.02	0.42	1.43	172	6.77	126	4.96	2600	1.220	1.420
X30222	Y30222	322	430	0.6	0.02	0.42	1.43	181	7.13	134	5.26	2500	1.450	1.650
X30224	Y30224	348	473	-0.6	-0.02	0.44	1.38	195	7.68	144	5.67	2400	1.810	2.000
X30226	Y30226	377	510	-2.3	-0.09	0.44	1.38	210	8.27	157	6.18	2000	4.830	2.130
X30302	Y30302	21.6	18.9	4.6	0.18	0.29	2.11	36	1.42	22	0.87	12000	0.061	0.034
X30303	Y30303	27.1	24.2	4.8	0.19	0.29	2.11	41	1.61	25	0.98	10000	0.095	0.046
X30304	Y30304	31.9	29.7	5.1	0.20	0.30	2.00	45	1.77	28	1.10	9500	0.105	0.060
X30305	Y30305	45.8	43.9	5.2	0.20	0.30	2.00	54	2.13	35	1.38	8000	0.176	0.087
X30306	Y30306	57.5	57.5	5.5	0.22	0.31	1.90	63	2.48	41	1.61	7000	0.255	0.134
X30307	Y30307	74.6	76.9	5.9	0.23	0.31	1.90	71	2.80	47	1.85	6400	0.348	0.170
X30308	Y30308	89.6	99.4	5.7	0.22	0.35	1.74	79	3.11	53	2.09	5500	0.491	0.257
X30309	Y30309	108	121	5.9	0.23	0.35	1.74	89	3.50	59	2.32	5000	0.658	0.328
X30310	Y30310	129	146	6.3	0.25	0.35	1.74	98	3.86	66	2.60	4700	0.882	0.403
X30311	Y30311	153	176	6.6	0.26	0.35	1.74	107	4.21	73	2.87	4300	1.110	0.514
X30312	Y30312	174	202	6.9	0.27	0.35	1.74	116	4.57	79	3.11	4000	1.380	0.621
X30313	Y30313	199	233	7.3	0.29	0.35	1.74	126	4.95	85	3.33	3800	1.700	0.744

ISO METRIC SERIES

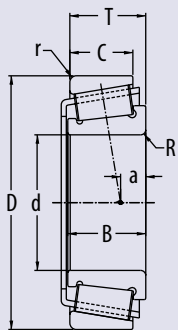

The tables include the most common industry series and sizes in the market. Additional industry series and sizes are available from PEER upon request.

Cone	Cup	d		B		R		D		C		r		T	
		Cone Bore		Cone Width		Max Shaft Radius		Cup Outer Diameter		Cup Width		Max Housing Radius		Total Width	
		mm	inch	mm	inch	mm	inch	mm	inch	mm	inch	mm	inch	mm	inch
X30314	Y30314	70.000	2.7559	35.000	1.3780	3.0	0.12	150.000	5.9055	30.000	1.1811	2.5	0.10	38.000	1.4961
X30315	Y30315	75.000	2.9528	37.000	1.4567	3.0	0.12	160.000	6.2992	31.000	1.2205	2.5	0.10	40.000	1.5748
X30316	Y30316	80.000	3.1496	39.000	1.5354	3.0	0.12	170.000	6.6929	33.000	1.2992	2.5	0.10	42.500	1.6732
X30317	Y30317	85.000	3.3465	41.000	1.6142	4.0	0.16	180.000	7.0866	34.000	1.3386	3.0	0.12	44.500	1.7520
X30318	Y30318	90.000	3.5433	43.000	1.6929	4.0	0.16	190.000	7.4803	36.000	1.4173	3.0	0.12	46.500	1.8307
X30319	Y30319	95.000	3.7402	45.000	1.7717	4.0	0.16	200.000	7.8740	38.000	1.4961	3.0	0.12	49.500	1.9488
X30320	Y30320	100.000	3.9370	47.000	1.8504	4.0	0.16	215.000	8.4646	39.000	1.5354	3.0	0.12	51.500	2.0276
X30321	Y30321	105.000	4.1339	49.000	1.9291	4.0	0.16	225.000	8.8583	41.000	1.6142	3.0	0.12	53.500	2.1063
X30322	Y30322	110.000	4.3307	50.000	1.9685	4.0	0.16	240.000	9.4488	42.000	1.6535	3.0	0.12	54.500	2.1457
X31305	Y31305	25.000	0.9843	17.000	0.6693	1.5	0.06	62.000	2.4409	13.000	0.5118	1.5	0.06	18.250	0.7185
X31306	Y31306	30.000	1.1811	19.000	0.7480	1.5	0.06	72.000	2.8346	14.000	0.5512	1.5	0.06	20.750	0.8169
X31307	Y31307	35.000	1.3780	21.000	0.8268	2.0	0.08	80.000	3.1496	15.000	0.5906	1.5	0.06	22.750	0.8957
X31308	Y31308	40.000	1.5748	23.000	0.9055	2.0	0.08	90.000	3.5433	17.000	0.6693	1.5	0.06	25.250	0.9941
X31309	Y31309	45.000	1.7717	25.000	0.9843	2.0	0.08	100.000	3.9370	18.000	0.7087	1.5	0.06	27.250	1.0728
X31310	Y31310	50.000	1.9685	27.000	1.0630	2.5	0.10	110.000	4.3307	19.000	0.7480	2.0	0.08	29.250	1.1516
X31311	Y31311	55.000	2.1654	29.000	1.1417	2.5	0.10	120.000	4.7244	21.000	0.8268	2.0	0.08	31.500	1.2402
X31312	Y31312	60.000	2.3622	31.000	1.2205	3.0	0.12	130.000	5.1181	22.000	0.8661	2.5	0.10	33.500	1.3189
X31313	Y31313	65.000	2.5591	33.000	1.2992	3.0	0.12	140.000	5.5118	23.000	0.9055	2.5	0.10	36.000	1.4173
X31314	Y31314	70.000	2.7559	35.000	1.3780	3.0	0.12	150.000	5.9055	25.000	0.9843	2.5	0.10	28.000	1.1024
X31315	Y31315	75.000	2.9528	37.000	1.4567	3.0	0.12	160.000	6.2992	26.000	1.0236	2.5	0.10	40.000	1.5748
X31316	Y31316	80.000	3.1496	39.000	1.5354	3.0	0.12	170.000	6.6929	27.000	1.0630	2.5	0.10	42.500	1.6732
X31317	Y31317	85.000	3.3465	41.000	1.6142	4.0	0.16	180.000	7.0866	28.000	1.1024	3.0	0.12	44.500	1.7520
X31318	Y31318	90.000	3.5433	43.000	1.6929	4.0	0.16	190.000	7.4803	30.000	1.1811	3.0	0.12	46.500	1.8307
X32004X	Y32004X	20.000	0.7874	15.000	0.5906	0.6	0.02	42.000	1.6535	12.000	0.4724	0.6	0.02	15.000	0.5906
X32005X	Y32005X	25.000	0.9843	15.000	0.5906	0.6	0.02	47.000	1.8504	11.500	0.4528	0.6	0.02	15.000	0.5906
X32006X	Y32006X	30.000	1.1811	17.000	0.6693	1.0	0.04	55.000	2.1654	13.000	0.5118	1.0	0.04	17.000	0.6693
X32007X	Y32007X	35.000	1.3780	18.000	0.7087	1.0	0.04	62.000	2.4409	14.000	0.5512	1.0	0.04	18.000	0.7087
X32008X	Y32008X	40.000	1.5748	19.000	0.7480	1.0	0.04	68.000	2.6772	14.500	0.5709	1.0	0.04	19.000	0.7480
X32009X	Y32009X	45.000	1.7717	20.000	0.7874	1.0	0.04	75.000	2.9528	15.500	0.6102	1.0	0.04	20.000	0.7874
X32010X	Y32010X	50.000	1.9685	20.000	0.7874	1.0	0.04	80.000	3.1496	15.500	0.6102	1.0	0.04	20.000	0.7874
X32011X	Y32011X	55.000	2.1654	23.000	0.9055	1.5	0.06	90.000	3.5433	17.500	0.6890	1.5	0.06	23.000	0.9055
X32012X	Y32012X	60.000	2.3622	23.000	0.9055	1.5	0.06	95.000	3.7402	17.500	0.6890	1.5	0.06	23.000	0.9055
X32013X	Y32013X	65.000	2.5591	23.000	0.9055	1.5	0.06	100.000	3.9370	17.500	0.6890	1.5	0.06	23.000	0.9055
X32014X	Y32014X	70.000	2.7559	25.000	0.9843	1.5	0.06	110.000	4.3307	19.000	0.7480	1.5	0.06	25.000	0.9843

$$P = X \cdot Fr + Y \cdot Fa$$

$\frac{Fa}{Fr} \leq e$		$\frac{Fa}{Fr} > e$	
X	Y	X	Y
1	0	0.40	See table

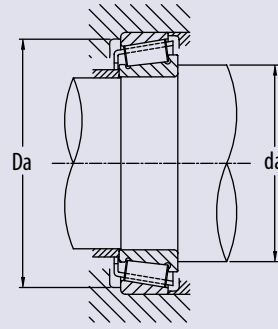

Cone	Cup	Basic Load Rating		a		e	Y Axial Load Factor	Da		da		Reference Speed RPM	Cone Weight Kg	Cup Weight Kg
		Dynamic Cr	Static Cor	Effective Load Center				Housing Bore ID		Shaft OD				
		KN	KN	mm	inch			mm	inch	mm	inch			
X30314	Y30314	223	262	7.3	0.29	0.35	1.74	135	5.33	91	3.56	3600	2.070	0.914
X30315	Y30315	258	309	8.0	0.31	0.35	1.74	144	5.67	97	3.82	3300	2.520	1.060
X30316	Y30316	287	345	8.1	0.32	0.35	1.74	153	6.02	104	4.09	3000	3.050	1.230
X30317	Y30317	314	380	8.6	0.34	0.35	1.74	163	6.41	111	4.36	3000	3.460	1.510
X30318	Y30318	353	432	9.0	0.35	0.35	1.74	171	6.73	116	4.57	2900	4.070	1.760
X30319	Y30319	381	468	9.4	0.37	0.35	1.74	180	7.09	121	4.76	2800	4.630	2.190
X30320	Y30320	426	526	9.3	0.37	0.35	1.74	194	7.64	129	5.08	2600	5.620	2.610
X30321	Y30321	454	562	9.9	0.39	0.35	1.74	203	7.99	135	5.31	2500	6.400	3.020
X30322	Y30322	495	612	9.4	0.37	0.35	1.74	217	8.54	142	5.59	2300	7.510	3.490
X31305	Y31305	39.6	41.9	-1.9	-0.07	0.83	0.73	52	2.03	37	1.45	8000	0.169	0.094
X31306	Y31306	51.6	55.5	-2.3	-0.09	0.83	0.73	60	2.37	43	1.69	7500	0.255	0.138
X31307	Y31307	64.3	70.3	3.0	0.12	0.83	0.73	67	2.64	49	1.93	6000	0.345	0.170
X31308	Y31308	79.3	87.8	3.8	0.15	0.83	0.73	77	3.03	55	2.17	5500	0.496	0.232
X31309	Y31309	94	105	-4.5	-0.18	0.83	0.73	86	3.39	61	2.41	5500	0.642	0.300
X31310	Y31310	105	117	-5.5	-0.22	0.83	0.73	95	3.73	67	2.65	5200	0.824	0.389
X31311	Y31311	128	146	-6.1	-0.24	0.83	0.73	103	4.06	73	2.89	4800	1.030	0.527
X31312	Y31312	148	170	-6.9	-0.27	0.83	0.73	112	4.39	80	3.15	4500	1.280	0.622
X31313	Y31313	168	195	-8.2	-0.32	0.83	0.73	121	4.76	86	3.38	4200	1.610	0.750
X31314	Y31314	190	223	-8.8	-0.35	0.83	0.73	129	5.08	92	3.64	4000	1.910	0.949
X31315	Y31315	213	250	-9.7	-0.38	0.83	0.73	138	5.43	99	3.90	3800	2.300	1.090
X31316	Y31316	236	280	-10.3	-0.41	0.83	0.73	147	5.79	104	4.09	3600	2.740	1.320
X31317	Y31317	261	312	-11.1	-0.44	0.83	0.73	156	6.14	111	4.37	3400	3.190	1.520
X31318	Y31318	290	349	-12.0	-0.47	0.83	0.73	165	6.50	117	4.61	3200	3.700	1.780
X32004X	Y32004X	23	25.3	4.7	0.19	0.37	1.60	36	1.42	26	1.02	11000	0.061	0.035
X32005X	Y32005X	25.9	30.8	3.4	0.13	0.43	1.39	41	1.61	31	1.22	9000	0.075	0.039
X32006X	Y32006X	33.1	42.4	3.7	0.15	0.43	1.39	48	1.89	38	1.50	8000	0.118	0.055
X32007X	Y32007X	41.2	55.7	2.9	0.11	0.45	1.32	55	2.17	43	1.69	6500	0.157	0.072
X32008X	Y32008X	49.4	66.6	4.1	0.16	0.38	1.58	61	2.40	48	1.89	6000	0.189	0.084
X32009X	Y32009X	55.8	76.9	3.5	0.14	0.39	1.53	68	2.68	53	2.09	5500	0.236	0.103
X32010X	Y32010X	58.3	83.7	2.2	0.09	0.42	1.42	73	2.87	58	2.28	5000	0.255	0.111
X32011X	Y32011X	75.9	109	3.2	0.13	0.41	1.48	81	3.19	65	2.56	4700	0.400	0.158
X32012X	Y32012X	77.5	114	2.1	0.08	0.43	1.39	86	3.39	70	2.76	4500	0.409	0.178
X32013X	Y32013X	78.4	119	0.6	0.02	0.46	1.31	91	3.58	75	2.95	4200	0.441	0.183
X32014X	Y32014X	99.4	150	1.2	0.05	0.43	1.38	100	3.94	81	3.19	3800	0.583	0.261

ISO METRIC SERIES

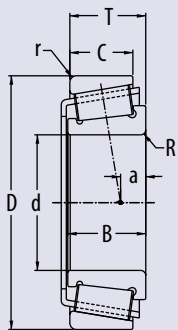

The tables include the most common industry series and sizes in the market. Additional industry series and sizes are available from PEER upon request.

Cone	Cup	d		B		R		D		C		r		T	
		Cone Bore		Cone Width		Max Shaft Radius		Cup Outer Diameter		Cup Width		Max Housing Radius		Total Width	
		mm	inch	mm	inch	mm	inch	mm	inch	mm	inch	mm	inch	mm	inch
X32015X	Y32015X	75.000	2.9528	25.000	0.9843	1.5	0.06	115.000	4.5276	19.000	0.7480	1.5	0.06	25.000	0.9843
X32016X	Y32016X	80.000	3.1496	29.000	1.1417	1.5	0.06	125.000	4.9213	22.000	0.8661	1.5	0.06	29.000	1.1417
X32017X	Y32017X	85.000	3.3465	29.000	1.1417	1.5	0.06	130.000	5.1181	22.000	0.8661	1.5	0.06	29.000	1.1417
X32018X	Y32018X	90.000	3.5433	32.000	1.2598	2.0	0.08	140.000	5.5118	24.000	0.9449	1.5	0.06	32.000	1.2598
X32019X	Y32019X	95.000	3.7402	32.000	1.2598	2.0	0.08	145.000	5.7087	24.000	0.9449	1.5	0.06	32.000	1.2598
X32020X	Y32020X	100.000	3.9370	32.000	1.2598	2.0	0.08	150.000	5.9055	24.000	0.9449	1.5	0.06	32.000	1.2598
X32021X	Y32021X	105.000	4.1339	35.000	1.3780	2.5	0.10	160.000	6.2992	26.000	1.0236	2.0	0.08	35.000	1.3780
X32022X	Y32022X	110.000	4.3307	38.000	1.4961	2.5	0.10	170.000	6.6929	29.000	1.1417	2.0	0.08	38.000	1.4961
X32024X	Y32024X	120.000	4.7244	38.000	1.4961	2.5	0.10	180.000	7.0866	29.000	1.1417	2.0	0.08	38.000	1.4961
X32026X	Y32026X	130.000	5.1181	45.000	1.7717	2.5	0.10	200.000	7.8740	34.000	1.3386	2.0	0.08	45.000	1.7717
X32028X	Y32028X	140.000	5.5118	45.000	1.7717	2.5	0.10	210.000	8.2677	34.000	1.3386	2.0	0.08	45.000	1.7717
X32030X	Y32030X	150.000	5.9055	48.000	1.8898	3.0	0.12	225.000	8.8583	36.000	1.4173	2.5	0.10	48.000	1.8898
X32032X	Y32032X	160.000	6.2992	51.000	2.0079	3.0	0.12	240.000	9.4488	38.000	1.4961	2.5	0.10	51.000	2.0079
X32204	Y32204	20.000	0.7874	18.000	0.7087	1.0	0.04	47.000	1.8504	15.000	0.5906	1.0	0.04	19.250	0.7579
X32205	Y32205	25.000	0.9843	18.000	0.7087	1.0	0.04	52.000	2.0472	15.000	0.5906	1.0	0.04	19.250	0.7579
X32206	Y32206	30.000	1.1811	20.000	0.7874	1.0	0.04	62.000	2.4409	17.000	0.6693	1.0	0.04	21.250	0.8366
X32207	Y32207	35.000	1.3780	23.000	0.9055	1.5	0.06	72.000	2.8346	19.000	0.7480	1.5	0.06	24.250	0.9547
X32208	Y32208	40.000	1.5748	23.000	0.9055	1.5	0.06	80.000	3.1496	19.000	0.7480	1.5	0.06	24.750	0.9744
X32209	Y32209	45.000	1.7717	23.000	0.9055	1.5	0.06	85.000	3.3465	19.000	0.7480	1.5	0.06	24.750	0.9744
X32210	Y32210	50.000	1.9685	23.000	0.9055	1.5	0.06	90.000	3.5433	19.000	0.7480	1.5	0.06	24.750	0.9744
X32211	Y32211	55.000	2.1654	25.000	0.9843	2.0	0.08	100.000	3.9370	21.000	0.8268	1.5	0.06	26.750	1.0531
X32212	Y32212	60.000	2.3622	28.000	1.1024	2.0	0.08	110.000	4.3307	24.000	0.9449	1.5	0.06	29.750	1.1713
X32213	Y32213	65.000	2.5591	31.000	1.2205	2.0	0.08	120.000	4.7244	27.000	1.0630	1.5	0.06	32.750	1.2894
X32214	Y32214	70.000	2.7559	31.000	1.2205	2.0	0.08	125.000	4.9213	27.000	1.0630	1.5	0.06	33.250	1.3091
X32215	Y32215	75.000	2.9528	31.000	1.2205	2.0	0.08	130.000	5.1181	27.000	1.0630	1.5	0.06	33.250	1.3091
X32216	Y32216	80.000	3.1496	33.000	1.2992	2.5	0.10	140.000	5.5118	28.000	1.1024	2.0	0.08	35.250	1.3878
X32217	Y32217	85.000	3.3465	36.000	1.4173	2.5	0.10	150.000	5.9055	30.000	1.1811	2.0	0.08	38.500	1.5157
X32218	Y32218	90.000	3.5433	40.000	1.5748	2.5	0.10	160.000	6.2992	34.000	1.3386	2.0	0.08	42.500	1.6732
X32219	Y32219	95.000	3.7402	43.000	1.6929	3.0	0.12	170.000	6.6929	37.000	1.4567	2.5	0.10	45.500	1.7913
X32220	Y32220	100.000	3.9370	46.000	1.8110	3.0	0.12	180.000	7.0866	39.000	1.5354	2.5	0.10	49.000	1.9291
X32221	Y32221	105.000	4.1339	50.000	1.9685	3.0	0.12	190.000	7.4803	43.000	1.6929	2.5	0.10	53.000	2.0866
X32222	Y32222	110.000	4.3307	53.000	2.0866	3.0	0.12	200.000	7.8740	46.000	1.8110	2.5	0.10	56.000	2.2047
X32224	Y32224	120.000	4.7244	58.000	2.2835	3.0	0.12	215.000	8.4646	50.000	1.9685	2.5	0.10	61.500	2.4213
X32304	Y32304	20.000	0.7874	21.000	0.8268	1.5	0.06	52.000	2.0472	18.000	0.7087	1.5	0.06	22.250	0.8760

$$P = X \cdot Fr + Y \cdot Fa$$

$\frac{Fa}{Fr} \leq e$		$\frac{Fa}{Fr} > e$	
X	Y	X	Y
1	0	0.40	See table

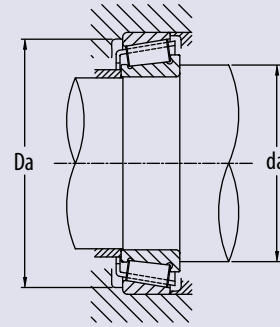

Cone	Cup	Basic Load Rating		a		e	Y Axial Load Factor	Da		da		Reference Speed RPM	Cone Weight Kg	Cup Weight Kg
		Dynamic Cr	Static Cor	Effective Load Center				Housing Bore ID		Shaft OD				
		KN	KN	mm	inch			mm	inch	mm	inch			
X32015X	Y32015X	98.2	151	0.2	0.01	0.46	1.31	105	4.13	86	3.39	3700	0.607	0.273
X32016X	Y32016X	135	209	2.2	0.09	0.42	1.42	115	4.53	92	3.62	3400	0.911	0.364
X32017X	Y32017X	133	207	0.9	0.04	0.44	1.36	119	4.69	98	3.86	3300	0.936	0.388
X32018X	Y32018X	164	256	2.0	0.08	0.42	1.42	128	5.04	104	4.09	3100	1.210	0.516
X32019X	Y32019X	167	266	0.6	0.02	0.44	1.36	132	5.20	109	4.29	3000	1.280	0.524
X32020X	Y32020X	165	266	0.8	0.03	0.46	1.31	138	5.43	114	4.49	2900	1.300	0.558
X32021X	Y32021X	196	317	0.5	0.02	0.44	1.35	146	5.75	121	4.76	2800	1.710	0.701
X32022X	Y32022X	234	380	1.4	0.06	0.43	1.39	155	6.10	127	5.00	2600	2.160	0.877
X32024X	Y32024X	231	381	-1.3	-0.05	0.46	1.31	166	6.52	137	5.41	2500	2.250	0.960
X32026X	Y32026X	321	540	1.7	0.07	0.43	1.38	183	7.20	149	5.87	2300	3.520	1.430
X32028X	Y32028X	317	541	-1.0	-0.04	0.46	1.31	193	7.60	160	6.30	2200	3.600	1.560
X32030X	Y32030X	360	620	-1.2	-0.05	0.46	1.31	207	8.15	172	6.77	2000	4.380	1.900
X32032X	Y32032X	412	718	-1.6	-0.06	0.46	1.31	221	8.70	183	7.20	1800	5.460	2.240
X32204	Y32204	29.7	30.2	6.6	0.26	0.33	1.81	40	1.57	27	1.06	11000	0.092	0.062
X32205	Y32205	36.8	38.8	5.3	0.21	0.36	1.67	45	1.77	32	1.26	9500	0.117	0.064
X32206	Y32206	51.2	59	5.6	0.22	0.37	1.60	54	2.13	38	1.50	8000	0.184	0.104
X32207	Y32207	70.5	84.1	6.4	0.25	0.37	1.60	62	2.44	45	1.77	6500	0.292	0.156
X32208	Y32208	78.5	92.3	5.8	0.23	0.37	1.60	70	2.76	51	2.01	6000	0.346	0.181
X32209	Y32209	81.2	98.9	4.6	0.18	0.40	1.48	75	2.95	56	2.20	5500	0.386	0.188
X32210	Y32210	83.3	102	3.7	0.15	0.42	1.43	80	3.15	61	2.40	5400	0.425	0.203
X32211	Y32211	108	133	3.9	0.15	0.40	1.48	90	3.54	67	2.64	4800	0.583	0.275
X32212	Y32212	133	169	4.7	0.19	0.40	1.48	99	3.90	72	2.83	4500	0.773	0.399
X32213	Y32213	161	209	5.5	0.22	0.40	1.48	108	4.25	79	3.11	4000	1.060	0.491
X32214	Y32214	169	224	4.4	0.17	0.42	1.43	113	4.45	84	3.31	3900	1.120	0.529
X32215	Y32215	170	228	3.3	0.13	0.44	1.38	118	4.65	90	3.54	3700	1.210	0.534
X32216	Y32216	199	264	3.9	0.15	0.42	1.43	127	5.00	95	3.74	3500	1.470	0.660
X32217	Y32217	232	314	4.6	0.18	0.42	1.43	134	5.28	102	4.02	3300	1.830	0.856
X32218	Y32218	276	385	5.7	0.22	0.42	1.43	143	5.63	108	4.25	3100	2.330	1.110
X32219	Y32219	310	437	6.3	0.25	0.42	1.43	151	5.94	115	4.53	3000	2.860	1.390
X32220	Y32220	351	501	7.1	0.28	0.42	1.43	160	6.30	122	4.80	2900	3.430	1.670
X32221	Y32221	392	567	8.0	0.31	0.42	1.43	169	6.65	128	5.04	2800	4.150	2.110
X32222	Y32222	447	657	8.7	0.34	0.42	1.43	179	7.05	134	5.28	2400	5.020	2.430
X32224	Y32224	495	748	9.2	0.36	0.44	1.38	192	7.56	145	5.71	2200	6.140	3.140
X32304	Y32304	42.2	42.9	8.7	0.34	0.30	2.00	44	1.73	29	1.14	10000	0.141	0.092

ISO METRIC SERIES

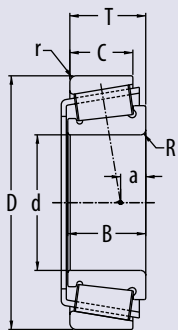

The tables include the most common industry series and sizes in the market. Additional industry series and sizes are available from PEER upon request.

Cone	Cup	d		B		R		D		C		r		T	
		Cone Bore		Cone Width		Max Shaft Radius		Cup Outer Diameter		Cup Width		Max Housing Radius		Total Width	
		mm	inch	mm	inch	mm	inch	mm	inch	mm	inch	mm	inch	mm	inch
X32305	Y32305	25.000	0.9843	24.000	0.9449	1.5	0.06	62.000	2.4409	20.000	0.7874	1.5	0.06	25.250	0.9941
X32306	Y32306	30.000	1.1811	27.000	1.0630	1.5	0.06	72.000	2.8346	23.000	0.9055	1.5	0.06	28.750	1.1319
X32307	Y32307	35.000	1.3780	31.000	1.2205	2.0	0.08	80.000	3.1496	25.000	0.9843	1.5	0.06	32.750	1.2894
X32307B	Y32307B	35.000	1.3780	31.000	1.2205	2.0	0.08	80.000	3.1496	25.000	0.9843	1.5	0.06	32.750	1.2894
X32308	Y32308	40.000	1.5748	33.000	1.2992	2.0	0.08	90.000	3.5433	27.000	1.0630	1.5	0.06	35.250	1.3878
X32308B	Y32308B	40.000	1.5748	33.000	1.2992	2.0	0.08	90.000	3.5433	27.000	1.0630	1.5	0.06	35.250	1.3878
X32309	Y32309	45.000	1.7717	36.000	1.4173	2.0	0.08	100.000	3.9370	30.000	1.1811	1.5	0.06	38.250	1.5059
X32309B	Y32309B	45.000	1.7717	36.000	1.4173	2.0	0.08	100.000	3.9370	30.000	1.1811	1.5	0.06	38.250	1.5059
X32310	Y32310	50.000	1.9685	40.000	1.5748	2.5	0.10	110.000	4.3307	33.000	1.2992	2.0	0.08	42.250	1.6634
X32310B	Y32310B	50.000	1.9685	40.000	1.5748	2.5	0.10	110.000	4.3307	33.000	1.2992	2.0	0.08	42.250	1.6634
X32311	Y32311	55.000	2.1654	43.000	1.6929	2.5	0.10	120.000	4.7244	35.000	1.3780	2.0	0.08	45.500	1.7913
X32311B	Y32311B	55.000	2.1654	43.000	1.6929	2.5	0.10	120.000	4.7244	35.000	1.3780	2.0	0.08	45.500	1.7913
X32312	Y32312	60.000	2.3622	46.000	1.8110	3.0	0.12	130.000	5.1181	37.000	1.4567	2.5	0.10	48.500	1.9094
X32312B	Y32312B	60.000	2.3622	46.000	1.8110	3.0	0.12	130.000	5.1181	37.000	1.4567	2.5	0.10	48.500	1.9094
X32313	Y32313	65.000	2.5591	48.000	1.8898	3.0	0.12	140.000	5.5118	39.000	1.5354	2.5	0.10	51.000	2.0079
X32314	Y32314	70.000	2.7559	51.000	2.0079	3.0	0.12	150.000	5.9055	42.000	1.6535	2.5	0.10	54.000	2.1260
X32315	Y32315	75.000	2.9528	55.000	2.1654	3.0	0.12	160.000	6.2992	45.000	1.7717	2.5	0.10	58.000	2.2835
X32316	Y32316	80.000	3.1496	58.000	2.2835	3.0	0.12	170.000	6.6929	48.000	1.8898	2.5	0.10	61.500	2.4213
X32317	Y32317	85.000	3.3465	60.000	2.3622	4.0	0.16	180.000	7.0866	49.000	1.9291	3.0	0.12	63.500	2.5000
X33010	Y33010	50.000	1.9685	24.000	0.9449	1.0	0.04	80.000	3.1496	19.000	0.7480	1.0	0.04	24.000	0.9449
X33011	Y33011	55.000	2.1654	27.000	1.0630	1.5	0.06	90.000	3.5433	21.000	0.8268	1.5	0.06	27.000	1.0630
X33012	Y33012	60.000	2.3622	27.000	1.0630	1.5	0.06	95.000	3.7402	21.000	0.8268	1.5	0.06	27.000	1.0630
X33013	Y33013	65.000	2.5591	27.000	1.0630	1.5	0.06	100.000	3.9370	21.000	0.8268	1.5	0.06	27.000	1.0630
X33014	Y33014	70.000	2.7559	31.000	1.2205	1.5	0.06	110.000	4.3307	25.500	1.0039	1.5	0.06	31.000	1.2205
X33015	Y33015	75.000	2.9528	31.000	1.2205	1.5	0.06	115.000	4.5276	25.500	1.0039	1.5	0.06	31.000	1.2205
X33016	Y33016	80.000	3.1496	36.000	1.4173	1.5	0.06	125.000	4.9213	29.500	1.1614	1.5	0.06	36.000	1.4173
X33017	Y33017	85.000	3.3465	36.000	1.4173	1.5	0.06	130.000	5.1181	29.500	1.1614	1.5	0.06	36.000	1.4173
X33018	Y33018	90.000	3.5433	39.000	1.5354	2.0	0.08	140.000	5.5118	32.500	1.2795	1.5	0.06	39.000	1.5354
X33019	Y33019	95.000	3.7402	39.000	1.5354	2.0	0.08	145.000	5.7087	32.500	1.2795	1.5	0.06	39.000	1.5354
X33020	Y33020	100.000	3.9370	39.000	1.5354	2.0	0.08	150.000	5.9055	32.500	1.2795	1.5	0.06	39.000	1.5354
X33021	Y33021	105.000	4.1339	43.000	1.6929	2.5	0.10	160.000	6.2992	34.000	1.3386	2.0	0.08	43.000	1.6929
X33022	Y33022	110.000	4.3307	47.000	1.8504	2.5	0.10	170.000	6.6929	37.000	1.4567	2.0	0.08	47.000	1.8504
X33108	Y33108	40.000	1.5748	26.000	1.0236	1.5	0.06	75.000	2.9528	20.500	0.8071	1.5	0.06	26.000	1.0236
X33109	Y33109	45.000	1.7717	26.000	1.0236	1.5	0.06	80.000	3.1496	20.500	0.8071	1.5	0.06	26.000	1.0236

$$P = X \cdot Fr + Y \cdot Fa$$

$\frac{Fa}{Fr} \leq e$		$\frac{Fa}{Fr} > e$	
X	Y	X	Y
1	0	0.40	See table

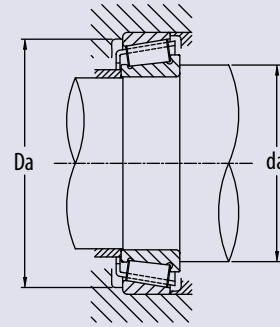

Cone	Cup	Basic Load Rating		a		e	Y Axial Load Factor	Da		da		Reference Speed RPM	Cone Weight Kg	Cup Weight Kg
		Dynamic Cr	Static Cor	Effective Load Center				Housing Bore ID		Shaft OD				
		KN	KN	mm	inch			mm	inch	mm	inch			
X32305	Y32305	61.9	65.1	9.4	0.37	0.30	2.00	53	2.09	35	1.38	8500	0.240	0.130
X32306	Y32306	82	91.4	9.9	0.39	0.31	1.90	62	2.44	41	1.61	7500	0.353	0.210
X32307	Y32307	99.1	112	12.3	0.48	0.31	1.90	69	2.72	47	1.85	7000	0.500	0.267
X32307B	Y32307B	95.9	117	7.6	0.30	0.55	1.10	66	2.60	49	1.93	7000	0.505	0.305
X32308	Y32308	116	140	11.9	0.47	0.35	1.74	78	3.07	53	2.09	6000	0.655	0.394
X32308B	Y32308B	106	137	7.9	0.31	0.55	1.10	75	2.95	55	2.17	6500	0.636	0.438
X32309	Y32309	146	180	12.6	0.50	0.35	1.74	87	3.43	60	2.36	5500	0.909	0.498
X32309B	Y32309B	138	177	7.5	0.30	0.55	1.10	84	3.31	60	2.36	5500	0.842	0.576
X32310	Y32310	179	225	14.1	0.56	0.35	1.74	96	3.78	66	2.60	5000	1.240	0.657
X32310B	Y32310B	165	224	8.7	0.34	0.55	1.10	92	3.62	68	2.68	5000	1.180	0.792
X32311	Y32311	206	260	15.1	0.59	0.35	1.74	105	4.13	71	2.80	4500	1.540	0.831
X32311B	Y32311B	188	250	9.7	0.38	0.55	1.10	101	3.98	74	2.91	5000	1.430	0.968
X32312	Y32312	233	295	16.5	0.65	0.35	1.74	113	4.45	79	3.11	4700	1.910	1.000
X32312B	Y32312B	219	294	9.2	0.36	0.55	1.10	109	4.29	81	3.19	4600	1.840	1.180
X32313	Y32313	267	341	16.7	0.66	0.35	1.74	123	4.84	85	3.35	4300	2.340	1.180
X32314	Y32314	313	407	17.5	0.69	0.35	1.74	132	5.20	92	3.62	4000	2.920	1.460
X32315	Y32315	358	473	18.6	0.73	0.35	1.74	141	5.55	97	3.81	3600	3.610	1.770
X32316	Y32316	402	535	19.4	0.76	0.35	1.74	150	5.91	104	4.09	3400	4.320	2.070
X32317	Y32317	437	584	20.0	0.79	0.35	1.74	159	6.26	110	4.33	3200	4.890	2.440
X33010	Y33010	73.9	106	7.0	0.28	0.32	1.90	72	2.83	58	2.28	5000	0.295	0.144
X33011	Y33011	90.8	137	8.0	0.31	0.31	1.92	82	3.23	73	2.87	4800	0.460	0.195
X33012	Y33012	92.8	143	7.2	0.28	0.33	1.83	86	3.39	70	2.76	4500	0.470	0.228
X33013	Y33013	94.5	150	6.1	0.24	0.35	1.72	91	3.58	75	2.95	4400	0.496	0.238
X33014	Y33014	130	211	9.0	0.35	0.28	2.11	101	3.96	81	3.19	3900	0.748	0.329
X33015	Y33015	129	211	8.2	0.32	0.30	2.01	105	4.13	86	3.39	3800	0.770	0.357
X33016	Y33016	177	293	10.8	0.43	0.28	2.16	114	4.49	92	3.62	3500	1.140	0.503
X33017	Y33017	175	294	9.8	0.39	0.29	2.06	119	4.69	98	3.86	3300	1.190	0.508
X33018	Y33018	216	355	11.4	0.45	0.27	2.23	129	5.08	101	3.98	3100	1.570	0.625
X33019	Y33019	224	374	10.6	0.42	0.28	2.16	134	5.28	108	4.25	3000	1.580	0.692
X33020	Y33020	224	390	9.9	0.39	0.29	2.09	138	5.43	110	4.33	2900	1.580	0.762
X33021	Y33021	249	419	12.2	0.48	0.28	2.12	147	5.79	120	4.72	2850	2.090	0.901
X33022	Y33022	280	483	13.8	0.54	0.29	2.09	155	6.10	127	5.00	2800	2.550	1.210
X33108	Y33108	81	104	8.0	0.31	0.36	1.69	66	2.60	50	1.97	6000	0.342	0.156
X33109	Y33109	83.3	111	6.9	0.27	0.38	1.57	71	2.80	54	2.13	5900	0.366	0.169

ISO METRIC SERIES

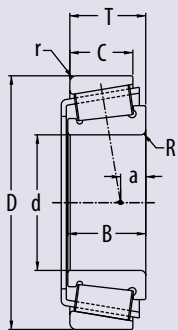

The tables include the most common industry series and sizes in the market. Additional industry series and sizes are available from PEER upon request.

Cone	Cup	d		B		R		D		C		r		T	
		Cone Bore		Cone Width		Max Shaft Radius		Cup Outer Diameter		Cup Width		Max Housing Radius		Total Width	
		mm	inch	mm	inch	mm	inch	mm	inch	mm	inch	mm	inch	mm	inch
X33110	Y33110	50.000	1.9685	26.000	1.0236	1.5	0.06	85.000	3.3465	20.000	0.7874	1.5	0.06	26.000	1.0236
X33111	Y33111	55.000	2.1654	30.000	1.1811	1.5	0.06	95.000	3.7402	23.000	0.9055	1.5	0.06	30.000	1.1811
X33112	Y33112	60.000	2.3622	30.000	1.1811	1.5	0.06	100.000	3.9370	23.000	0.9055	1.5	0.06	30.000	1.1811
X33113	Y33113	65.000	2.5591	34.000	1.3386	1.5	0.06	110.000	4.3307	26.500	1.0433	1.5	0.06	34.000	1.3386
X33114	Y33114	70.000	2.7559	37.000	1.4567	2.0	0.08	120.000	4.7244	29.000	1.1417	1.5	0.06	37.000	1.4567
X33115	Y33115	75.000	2.9528	37.000	1.4567	2.0	0.08	125.000	4.9213	29.000	1.1417	1.5	0.06	37.000	1.4567
X33116	Y33116	80.000	3.1496	37.000	1.4567	2.0	0.08	130.000	5.1181	29.000	1.1417	1.5	0.06	37.000	1.4567
X33117	Y33117	85.000	3.3465	41.000	1.6142	2.5	0.10	140.000	5.5118	32.000	1.2598	2.0	0.08	41.000	1.6142
X33118	Y33118	90.000	3.5433	45.000	1.7717	2.5	0.10	150.000	5.9055	35.000	1.3780	2.0	0.08	45.000	1.7717
X33205	Y33205	25.000	0.9843	22.000	0.8661	1.0	0.04	52.000	2.0472	18.000	0.7087	1.0	0.04	22.000	0.8661
X33206	Y33206	30.000	1.1811	25.000	0.9843	1.0	0.04	62.000	2.4409	19.500	0.7677	1.0	0.04	25.000	0.9843
X33207	Y33207	35.000	1.3780	28.000	1.1024	1.5	0.06	72.000	2.8346	22.000	0.8661	1.5	0.06	28.000	1.1024
X33208	Y33208	40.000	1.5748	32.000	1.2598	1.5	0.06	80.000	3.1496	25.000	0.9843	1.5	0.06	32.000	1.2598
X33209	Y33209	45.000	1.7717	32.000	1.2598	1.5	0.06	85.000	3.3465	25.000	0.9843	1.5	0.06	32.000	1.2598
X33210	Y33210	50.000	1.9685	32.000	1.2598	1.5	0.06	90.000	3.5433	24.500	0.9646	1.5	0.06	32.000	1.2598
X33211	Y33211	55.000	2.1654	35.000	1.3780	2.0	0.08	100.000	3.9370	27.000	1.0630	1.5	0.06	35.000	1.3780
X33212	Y33212	60.000	2.3622	38.000	1.4961	2.0	0.08	110.000	4.3307	29.000	1.1417	1.5	0.06	38.000	1.4961
X33213	Y33213	65.000	2.5591	41.000	1.6142	2.0	0.08	120.000	4.7244	32.000	1.2598	1.5	0.06	41.000	1.6142
X33214	Y33214	70.000	2.7559	41.000	1.6142	2.0	0.08	125.000	4.9213	32.000	1.2598	1.5	0.06	41.000	1.6142
X33215	Y33215	75.000	2.9528	41.000	1.6142	2.0	0.08	130.000	5.1181	32.000	1.2598	1.5	0.06	41.000	1.6142
X33216	Y33216	80.000	3.1496	46.000	1.8110	2.5	0.10	140.000	5.5118	35.000	1.3780	2.0	0.08	46.000	1.8110
X33217	Y33217	85.000	3.3465	49.000	1.9291	2.5	0.10	150.000	5.9055	37.000	1.4567	2.0	0.08	49.000	1.9291

$$P = X \cdot Fr + Y \cdot Fa$$

$\frac{Fa}{Fr} \leq e$		$\frac{Fa}{Fr} > e$	
X	Y	X	Y
1	0	0.40	See table

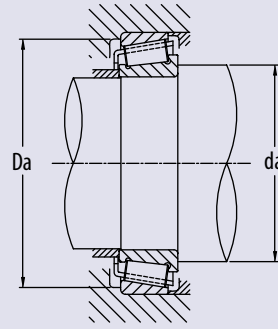

Cone	Cup	Basic Load Rating		a		e	Y Axial Load Factor	Da		da		Reference Speed RPM	Cone Weight Kg	Cup Weight Kg
		Dynamic Cr	Static Cor	Effective Load Center				Housing Bore ID		Shaft OD				
		KN	KN	mm	inch			mm	inch	mm	inch			
X33110	Y33110	85.4	117	5.6	0.22	0.41	1.46	76	2.99	60	2.36	5500	0.395	0.180
X33111	Y33111	111	158	8.1	0.32	0.37	1.60	85	3.35	66	2.60	4800	0.588	0.259
X33112	Y33112	114	167	6.9	0.27	0.40	1.51	90	3.54	72	2.83	4500	0.626	0.274
X33113	Y33113	138	211	8.0	0.31	0.39	1.55	99	3.90	78	3.07	4200	0.918	0.384
X33114	Y33114	166	255	8.8	0.35	0.38	1.58	108	4.25	85	3.35	4000	1.180	0.516
X33115	Y33115	170	268	7.6	0.30	0.40	1.51	112	4.41	90	3.54	3800	1.250	0.540
X33116	Y33116	173	279	6.3	0.25	0.42	1.44	117	4.61	92	3.62	3500	1.310	0.563
X33117	Y33117	209	340	7.9	0.31	0.41	1.48	126	4.96	102	4.02	3300	1.710	0.731
X33118	Y33118	244	398	10.1	0.40	0.40	1.51	135	5.31	108	4.25	3000	2.210	0.930
X33205	Y33205	47.5	56.5	8.0	0.31	0.35	1.71	45	1.77	32	1.26	9000	0.147	0.077
X33206	Y33206	61	71	9.3	0.37	0.34	1.76	54	2.13	39	1.54	8000	0.233	0.110
X33207	Y33207	79.3	96.5	9.8	0.39	0.35	1.70	63	2.48	45	1.77	7000	0.344	0.172
X33208	Y33208	103	130	11.2	0.44	0.36	1.68	70	2.76	51	2.01	6700	0.475	0.240
X33209	Y33209	106	140	10.1	0.40	0.39	1.56	75	2.95	56	2.20	6000	0.520	0.252
X33210	Y33210	110	149	8.8	0.35	0.41	1.45	80	3.15	61	2.40	5500	0.565	0.263
X33211	Y33211	137	186	9.9	0.39	0.40	1.50	89	3.50	68	2.68	5000	0.799	0.355
X33212	Y33212	160	221	10.5	0.41	0.40	1.48	97	3.82	74	2.91	4500	1.040	0.477
X33213	Y33213	195	269	11.5	0.45	0.39	1.54	107	4.21	80	3.15	4300	1.390	0.605
X33214	Y33214	201	285	10.3	0.41	0.41	1.47	112	4.41	85	3.35	4100	1.460	0.640
X33215	Y33215	209	286	9.1	0.36	0.43	1.40	116	4.57	90	3.54	4000	1.500	0.668
X33216	Y33216	238	347	10.9	0.43	0.43	1.41	124	4.88	97	3.82	3600	1.970	0.866
X33217	Y33217	273	400	12.1	0.48	0.42	1.43	134	5.28	103	4.06	3500	2.370	1.060

INCH AND ISO METRIC SERIES | BY CONE BORE

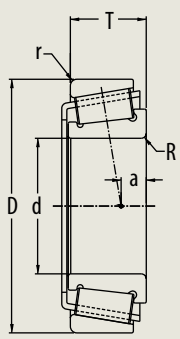

The tables include the most common industry series and sizes in the market. Additional industry series and sizes are available from PEER upon request.

Cone	Cup	Series	d		R		D		r		T		Basic Load Rating	
			Cone Bore		Max Shaft Radius		Cup Outer Diameter		Max Housing Radius		Total Width		Dynamic Cr	Static Cor
			mm	inch	mm	inch	mm	inch	mm	inch	mm	inch	KN	KN
X30302	Y30302	30302	15.000	0.5906	1.0	0.04	42.000	1.6535	1.0	0.04	14.250	0.5610	21.6	18.9
05062	05185	05000	15.875	0.6250	1.5	0.06	47.000	1.8504	1.3	0.05	14.381	0.5662	23.3	23.1
11590	11520	11500	15.875	0.6250	1.5	0.06	42.862	1.6875	1.5	0.06	14.287	0.5625	16	15.5
17580	17520	17500	15.875	0.6250	1.5	0.06	42.862	1.6875	1.5	0.06	16.670	0.6563	28.4	26.9
L21549	L21511	L21500	15.875	0.6250	1.3	0.05	34.989	1.3775	1.3	0.05	10.998	0.4330	12.7	12
HM81649	HM81610	HM81600	15.987	0.6294	1.0	0.04	46.975	1.8494	2.0	0.08	21.000	0.8268	34.4	35
X30203	Y30203	30203	17.000	0.6693	1.0	0.04	40.000	1.5748	1.0	0.04	13.250	0.5217	19.5	19.1
X30303	Y30303	30303	17.000	0.6693	1.0	0.04	47.000	1.8504	1.0	0.04	15.250	0.6004	27.1	24.2
LM11749	LM11710	LM11700	17.462	0.6875	1.3	0.05	39.878	1.5700	1.3	0.05	13.843	0.5450	21	20.5
A6075	A6157	A6000	19.050	0.7500	1.0	0.04	39.992	1.5745	1.3	0.05	12.014	0.4730	11.5	11.2
09078	09194	09000	19.050	0.7500	1.3	0.05	49.225	1.9380	3.5	0.14	23.020	0.9063	35.4	34.8
09067	09194	09000	19.050	0.7500	1.3	0.05	49.225	1.9380	3.5	0.14	21.209	0.8350	35.4	34.8
09074	09194	09000	19.050	0.7500	SP	SP	49.225	1.9380	3.5	0.14	23.020	0.9063	35.4	34.8
09078	09195	09000	19.050	0.7500	1.3	0.05	49.225	1.9380	1.3	0.05	19.845	0.7813	35.4	34.8
09067	09195	09000	19.050	0.7500	1.3	0.05	49.225	1.9380	1.3	0.05	18.034	0.7100	35.4	34.8
09074	09195	09000	19.050	0.7500	SP	SP	49.225	1.9380	1.3	0.05	19.845	0.7813	35.4	34.8
09078	09196	09000	19.050	0.7500	1.3	0.05	49.225	1.9380	1.5	0.06	23.020	0.9063	35.4	34.8
09067	09196	09000	19.050	0.7500	1.3	0.05	49.225	1.9380	1.5	0.06	21.209	0.8350	35.4	34.8
09074	09196	09000	19.050	0.7500	SP	SP	49.225	1.9380	1.5	0.06	23.020	0.9063	35.4	34.8
LM11949	LM11910	LM11900	19.050	0.7500	1.3	0.05	45.237	1.7810	1.3	0.05	15.494	0.6100	27.6	27.7
21075	21212	21000	19.050	0.7500	1.5	0.06	53.975	2.1250	2.3	0.09	22.225	0.8750	40	38.7
07079	07196	07000	20.000	0.7874	1.5	0.06	50.005	1.9687	1.0	0.04	13.495	0.5313	24.7	26
07079	07204	07000	20.000	0.7874	1.5	0.06	51.994	2.0470	1.3	0.05	15.011	0.5910	24.7	26
07079	07210X	07000	20.000	0.7874	1.5	0.06	50.800	2.0000	1.5	0.06	15.011	0.5910	24.7	26
X30204	Y30204	30204	20.000	0.7874	1.0	0.04	47.000	1.8504	1.0	0.04	15.250	0.6004	27.5	27.9
X30304	Y30304	30304	20.000	0.7874	1.5	0.06	52.000	2.0472	1.5	0.06	16.250	0.6398	31.9	29.7
X32004X	Y32004X	32004X	20.000	0.7874	0.6	0.02	42.000	1.6535	0.6	0.02	15.000	0.5906	23	25.3
X32204	Y32204	32204	20.000	0.7874	1.0	0.04	47.000	1.8504	1.0	0.04	19.250	0.7579	29.7	30.2
X32304	Y32304	32304	20.000	0.7874	1.5	0.06	52.000	2.0472	1.5	0.06	22.250	0.8760	42.2	42.9
12580	12520	12500	20.638	0.8125	1.5	0.06	49.225	1.9380	1.5	0.06	19.845	0.7813	35.2	36.1
M12649	M12610	M12600	21.430	0.8437	1.3	0.05	50.005	1.9687	1.3	0.05	17.526	0.6900	36.6	37.5
LM12748	LM12710	LM12700	21.430	0.8437	1.3	0.05	45.237	1.7810	1.3	0.05	15.494	0.6100	27.4	30.8
LM12748	LM12711	LM12700	21.430	0.8437	1.3	0.05	45.974	1.8100	1.3	0.05	15.494	0.6100	27.4	30.8
LM12749	LM12710	LM12700	21.986	0.8656	1.3	0.05	45.237	1.7810	1.3	0.05	15.494	0.6100	27.4	30.8

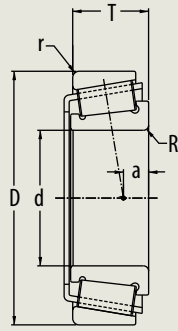

The tables include the most common industry series and sizes in the market. Additional industry series and sizes are available from PEER upon request.

Cone	Cup	Series	d		R		D		r		T		Basic Load Rating	
			Cone Bore		Max Shaft Radius		Cup Outer Diameter		Max Housing Radius		Total Width		Dynamic Cr	Static Cor
			mm	inch	mm	inch	mm	inch	mm	inch	mm	inch	KN	KN
LM12749	LM12711	LM12700	21.986	0.8656	1.3	0.05	45.974	1.8100	1.3	0.05	15.454	0.6084	27.4	30.8
1280	1220	1200	22.225	0.8750	0.8	0.03	57.150	2.2500	1.5	0.06	22.225	0.8750	49.5	52.7
1380	1328	1300	22.225	0.8750	1.5	0.06	52.388	2.0625	1.5	0.06	19.368	0.7625	39.4	41.2
1755	1729	1700	22.225	0.8750	1.3	0.05	56.896	2.2400	1.3	0.05	19.368	0.7625	37.3	38.9
1755	1729X	1700	22.225	0.8750	1.3	0.05	56.896	2.2400	1.5	0.06	19.368	0.7625	37.3	38.9
07087	07196	07000	22.225	0.8750	1.3	0.05	50.005	1.9687	1.0	0.04	13.495	0.5313	24.7	26
07087	07204	07000	22.225	0.8750	1.3	0.05	51.994	2.0470	1.3	0.05	15.011	0.5910	24.7	26
07087	07210X	07000	22.225	0.8750	1.3	0.05	50.800	2.0000	1.5	0.06	15.011	0.5910	24.7	26
M12648	M12610	M12600	22.225	0.8750	1.3	0.05	50.005	1.9687	1.3	0.05	17.526	0.6900	36.6	37.5
LM72849	LM72810	LM72800	22.606	0.8900	1.5	0.06	47.000	1.8504	1.0	0.04	15.500	0.6102	25.8	29.5
1779	1729	1700	23.812	0.9375	0.8	0.03	56.896	2.2400	1.3	0.05	19.368	0.7625	37.3	38.9
1779	1729X	1700	23.812	0.9375	0.8	0.03	56.896	2.2400	1.5	0.06	19.368	0.7625	37.3	38.9
07093	07196	07000	23.812	0.9375	1.5	0.06	50.005	1.9687	1.0	0.04	13.495	0.5313	24.7	26
07093	07204	07000	23.812	0.9375	1.5	0.06	51.994	2.0470	1.3	0.05	15.011	0.5910	24.7	26
07093	07210X	07000	23.812	0.9375	1.5	0.06	50.800	2.0000	1.5	0.06	15.011	0.5910	24.7	26
23092	23256	23000	23.812	0.9375	1.5	0.06	65.088	2.5625	1.5	0.06	22.225	0.8750	45.1	48
L44640	L44610	L44600	23.812	0.9375	1.5	0.06	50.292	1.9800	1.3	0.05	14.224	0.5600	25.7	29.2
07097	07196	07000	25.000	0.9843	1.5	0.06	50.005	1.9687	1.0	0.04	13.495	0.5313	24.7	26
07097	07204	07000	25.000	0.9843	1.5	0.06	51.994	2.0470	1.3	0.05	15.011	0.5910	24.7	26
07097	07210X	07000	25.000	0.9843	1.5	0.06	50.800	2.0000	1.5	0.06	15.011	0.5910	24.7	26
X30205	Y30205	30205	25.000	0.9843	1.0	0.04	52.000	2.0472	1.0	0.04	16.250	0.6398	31.6	34
X30305	Y30305	30305	25.000	0.9843	1.5	0.06	62.000	2.4409	1.5	0.06	18.250	0.7185	45.8	43.9
X31305	Y31305	31305	25.000	0.9843	1.5	0.06	62.000	2.4409	1.5	0.06	18.250	0.7185	39.6	41.9
X32005X	Y32005X	32005X	25.000	0.9843	0.6	0.02	47.000	1.8504	0.6	0.02	15.000	0.5906	25.9	30.8
X32205	Y32205	32205	25.000	0.9843	1.0	0.04	52.000	2.0472	1.0	0.04	19.250	0.7579	36.8	38.8
X32305	Y32305	32305	25.000	0.9843	1.5	0.06	62.000	2.4409	1.5	0.06	25.250	0.9941	61.9	65.1
X33205	Y33205	33205	25.000	0.9843	1.0	0.04	52.000	2.0472	1.0	0.04	22.000	0.8661	47.5	56.5
1780	1729	1700	25.400	1.0000	0.8	0.03	56.896	2.2400	1.3	0.05	19.368	0.7625	37.3	38.9
1780	1729X	1700	25.400	1.0000	0.8	0.03	56.896	2.2400	1.5	0.06	19.368	0.7625	37.3	38.9
1986	1922	1900	25.400	1.0000	1.3	0.05	57.150	2.2500	1.5	0.06	19.845	0.7813	39.3	42.5
07100	07196	07000	25.400	1.0000	1.0	0.04	50.005	1.9687	1.0	0.04	13.495	0.5313	24.7	26
07100	07204	07000	25.400	1.0000	1.0	0.04	51.994	2.0470	1.3	0.05	15.011	0.5910	24.7	26
07100	07210X	07000	25.400	1.0000	1.0	0.04	50.800	2.0000	1.5	0.06	15.011	0.5910	24.7	26
15100	15243	15000	25.400	1.0000	3.5	0.14	61.912	2.4375	2.0	0.08	19.050	0.7500	42.5	47.6

INCH AND ISO METRIC SERIES | BY CONE BORE

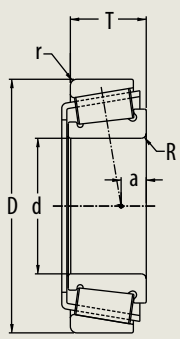

The tables include the most common industry series and sizes in the market. Additional industry series and sizes are available from PEER upon request.

Cone	Cup	Series	d		R		D		r		T		Basic Load Rating	
			Cone Bore		Max Shaft Radius		Cup Outer Diameter		Max Housing Radius		Total Width		Dynamic Cr	Static Cor
			mm	inch	mm	inch	mm	inch	mm	inch	mm	inch	KN	KN
15101	15243	15000	25.400	1.0000	0.8	0.03	61.912	2.4375	2.0	0.08	19.050	0.7500	42.5	47.6
15102	15243	15000	25.400	1.0000	1.5	0.06	61.912	2.4375	2.0	0.08	19.050	0.7500	42.5	47.6
15100	15245	15000	25.400	1.0000	3.5	0.14	62.000	2.4409	1.3	0.05	19.050	0.7500	42.5	47.6
15101	15245	15000	25.400	1.0000	0.8	0.03	62.000	2.4409	1.3	0.05	19.050	0.7500	42.5	47.6
15102	15245	15000	25.400	1.0000	1.5	0.06	62.000	2.4409	1.3	0.05	19.050	0.7500	42.5	47.6
15100	15250	15000	25.400	1.0000	3.5	0.14	63.500	2.5000	1.3	0.05	20.637	0.8125	42.5	47.6
15101	15250	15000	25.400	1.0000	0.8	0.03	63.500	2.5000	1.3	0.05	20.637	0.8125	42.5	47.6
15102	15250	15000	25.400	1.0000	1.5	0.06	63.500	2.5000	1.3	0.05	20.637	0.8125	42.5	47.6
15100	15250X	15000	25.400	1.0000	3.5	0.14	63.500	2.5000	1.5	0.06	20.637	0.8125	42.5	47.6
15101	15250X	15000	25.400	1.0000	0.8	0.03	63.500	2.5000	1.5	0.06	20.637	0.8125	42.5	47.6
15102	15250X	15000	25.400	1.0000	1.5	0.06	63.500	2.5000	1.5	0.06	20.637	0.8125	42.5	47.6
15578	15520	15500	25.400	1.0000	1.3	0.05	57.150	2.2500	1.5	0.06	17.462	0.6875	38.7	44.1
23100	23256	23000	25.400	1.0000	1.5	0.06	65.088	2.5625	1.5	0.06	22.225	0.8750	45.1	48
L44643	L44610	L44600	25.400	1.0000	1.3	0.05	50.292	1.9800	1.3	0.05	14.224	0.5600	25.7	29.2
M84249	M84210	M84200	25.400	1.0000	0.8	0.03	59.530	2.3437	1.5	0.06	23.368	0.9200	48.5	55.8
M84548	M84510	M84500	25.400	1.0000	1.5	0.06	57.150	2.2500	1.5	0.06	19.431	0.7650	40.9	46.6
M86643	M86610	M86600	25.400	1.0000	1.5	0.06	64.292	2.5312	1.5	0.06	21.433	0.8438	50.1	62.4
HM88630	HM88610	HM88600	25.400	1.0000	0.8	0.03	72.233	2.8438	2.3	0.09	25.400	1.0000	63.8	82.7
HM88630	HM88611	HM88600	25.400	1.0000	0.8	0.03	71.973	2.8336	1.5	0.06	27.000	1.0630	63.8	82.7
15103-S	15243	15000	26.162	1.0300	0.8	0.03	61.912	2.4375	2.0	0.08	19.050	0.7500	42.5	47.6
15103-S	15245	15000	26.162	1.0300	0.8	0.03	62.000	2.4409	1.3	0.05	19.050	0.7500	42.5	47.6
15103-S	15250	15000	26.162	1.0300	0.8	0.03	63.500	2.5000	1.3	0.05	20.637	0.8125	42.5	47.6
15103-S	15250X	15000	26.162	1.0300	0.8	0.03	63.500	2.5000	1.5	0.06	20.637	0.8125	42.5	47.6
15106	15243	15000	26.988	1.0625	0.8	0.03	61.912	2.4375	2.0	0.08	19.050	0.7500	42.5	47.6
15106	15245	15000	26.988	1.0625	0.8	0.03	62.000	2.4409	1.3	0.05	19.050	0.7500	42.5	47.6
15106	15250	15000	26.988	1.0625	0.8	0.03	63.500	2.5000	1.3	0.05	20.637	0.8125	42.5	47.6
15106	15250X	15000	26.988	1.0625	0.8	0.03	63.500	2.5000	1.5	0.06	20.637	0.8125	42.5	47.6
15580	15520	15500	26.988	1.0625	3.5	0.14	57.150	2.2500	1.5	0.06	17.462	0.6875	38.7	44.1
L44649	L44610	L44600	26.988	1.0625	3.5	0.14	50.292	1.9800	1.3	0.05	14.224	0.5600	25.7	29.2
2689	2631	2600	28.575	1.1250	1.3	0.05	66.421	2.6150	1.3	0.05	23.812	0.9375	64	70.8
02474	02420	02400	28.575	1.1250	0.8	0.03	68.262	2.6875	1.5	0.06	22.225	0.8750	61.6	82.5
02474	02421	02400	28.575	1.1250	0.8	0.03	68.262	2.6875	0.8	0.03	22.225	0.8750	61.6	82.5
02872	02820	02800	28.575	1.1250	0.8	0.03	73.025	2.8750	3.3	0.13	22.225	0.8750	55.9	67
15112	15243	15000	28.575	1.1250	3.5	0.14	61.912	2.4375	2.0	0.08	19.050	0.7500	42.5	47.6

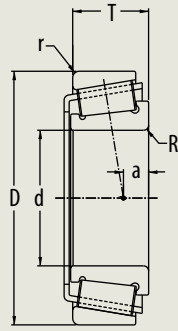

The tables include the most common industry series and sizes in the market. Additional industry series and sizes are available from PEER upon request.

Cone	Cup	Series	d		R		D		r		T		Basic Load Rating	
			Cone Bore		Max Shaft Radius		Cup Outer Diameter		Max Housing Radius		Total Width		Dynamic Cr	Static Cor
			mm	inch	mm	inch	mm	inch	mm	inch	mm	inch	KN	KN
15113	15243	15000	28.575	1.1250	0.8	0.03	61.912	2.4375	2.0	0.08	19.050	0.7500	42.5	47.6
15112	15245	15000	28.575	1.1250	3.5	0.14	62.000	2.4409	1.3	0.05	19.050	0.7500	42.5	47.6
15113	15245	15000	28.575	1.1250	0.8	0.03	62.000	2.4409	1.3	0.05	19.050	0.7500	42.5	47.6
15112	15250	15000	28.575	1.1250	3.5	0.14	63.500	2.5000	1.3	0.05	20.637	0.8125	42.5	47.6
15113	15250	15000	28.575	1.1250	0.8	0.03	63.500	2.5000	1.3	0.05	20.637	0.8125	42.5	47.6
15112	15250X	15000	28.575	1.1250	3.5	0.14	63.500	2.5000	1.5	0.06	20.637	0.8125	42.5	47.6
15113	15250X	15000	28.575	1.1250	0.8	0.03	63.500	2.5000	1.5	0.06	20.637	0.8125	42.5	47.6
15590	15520	15500	28.575	1.1250	3.5	0.14	57.150	2.2500	1.5	0.06	17.462	0.6875	38.7	44.1
41125	41286	41000	28.575	1.1250	4.8	0.19	72.626	2.8593	1.5	0.06	24.608	0.9688	59	57
41126	41286	41000	28.575	1.1250	1.5	0.06	72.626	2.8593	1.5	0.06	24.608	0.9688	59	57
L45449	L45410	L45400	29.000	1.1417	3.5	0.14	50.292	1.9800	1.3	0.05	14.224	0.5600	25.7	31.8
15117	15243	15000	29.987	1.1806	1.3	0.05	61.912	2.4375	2.0	0.08	19.050	0.7500	42.5	47.6
15117	15245	15000	29.987	1.1806	1.3	0.05	62.000	2.4409	1.3	0.05	19.050	0.7500	42.5	47.6
15117	15250	15000	29.987	1.1806	1.3	0.05	63.500	2.5000	1.3	0.05	20.637	0.8125	42.5	47.6
15117	15250X	15000	29.987	1.1806	1.3	0.05	63.500	2.5000	1.5	0.06	20.637	0.8125	42.5	47.6
17118	17244	17000	29.987	1.1806	1.5	0.06	62.000	2.4409	1.5	0.06	16.002	0.6300	35	36.6
26118	26283	26000	29.987	1.1806	1.5	0.06	72.000	2.8346	1.5	0.06	19.000	0.7480	49.1	52.3
X30206	Y30206	30206	30.000	1.1811	1.0	0.04	62.000	2.4409	1.0	0.04	17.250	0.6791	42	45.7
X30306	Y30306	30306	30.000	1.1811	1.5	0.06	72.000	2.8346	1.5	0.06	20.750	0.8169	57.5	57.5
X31306	Y31306	31306	30.000	1.1811	1.5	0.06	72.000	2.8346	1.5	0.06	20.750	0.8169	51.6	55.5
X32006X	Y32006X	32006X	30.000	1.1811	1.0	0.04	55.000	2.1654	1.0	0.04	17.000	0.6693	33.1	42.4
X32206	Y32206	32206	30.000	1.1811	1.0	0.04	62.000	2.4409	1.0	0.04	21.250	0.8366	51.2	59
X32306	Y32306	32306	30.000	1.1811	1.5	0.06	72.000	2.8346	1.5	0.06	28.750	1.1319	82	91.4
X33206	Y33206	33206	30.000	1.1811	1.0	0.04	62.000	2.4409	1.0	0.04	25.000	0.9843	61	71
15116	15243	15000	30.112	1.1855	0.8	0.03	61.912	2.4375	2.0	0.08	19.050	0.7500	42.5	47.6
15116	15245	15000	30.112	1.1855	0.8	0.03	62.000	2.4409	1.3	0.05	19.050	0.7500	42.5	47.6
15116	15250	15000	30.112	1.1855	0.8	0.03	63.500	2.5000	1.3	0.05	20.637	0.8125	42.5	47.6
15116	15250X	15000	30.112	1.1855	0.8	0.03	63.500	2.5000	1.5	0.06	20.637	0.8125	42.5	47.6
M86649	M86610	M86600	30.162	1.1875	1.5	0.06	64.292	2.5312	1.5	0.06	21.433	0.8438	50.1	62.4
15118	15243	15000	30.213	1.1895	3.5	0.14	61.912	2.4375	2.0	0.08	19.050	0.7500	42.5	47.6
15119	15243	15000	30.213	1.1895	1.5	0.06	61.912	2.4375	2.0	0.08	19.050	0.7500	42.5	47.6
15120	15243	15000	30.213	1.1895	0.8	0.03	61.912	2.4375	2.0	0.08	19.050	0.7500	42.5	47.6
15118	15245	15000	30.213	1.1895	3.5	0.14	62.000	2.4409	1.3	0.05	19.050	0.7500	42.5	47.6
15119	15245	15000	30.213	1.1895	1.5	0.06	62.000	2.4409	1.3	0.05	19.050	0.7500	42.5	47.6

INCH AND ISO METRIC SERIES | BY CONE BORE

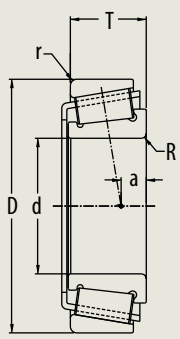

The tables include the most common industry series and sizes in the market. Additional industry series and sizes are available from PEER upon request.

Cone	Cup	Series	d		R		D		r		T		Basic Load Rating	
			Cone Bore		Max Shaft Radius		Cup Outer Diameter		Max Housing Radius		Total Width		Dynamic Cr	Static Cor
			mm	inch	mm	inch	mm	inch	mm	inch	mm	inch	KN	KN
15120	15245	15000	30.213	1.1895	0.8	0.03	62.000	2.4409	1.3	0.05	19.050	0.7500	42.5	47.6
15118	15250	15000	30.213	1.1895	3.5	0.14	63.500	2.5000	1.3	0.05	20.637	0.8125	42.5	47.6
15119	15250	15000	30.213	1.1895	1.5	0.06	63.500	2.5000	1.3	0.05	20.637	0.8125	42.5	47.6
15120	15250	15000	30.213	1.1895	0.8	0.03	63.500	2.5000	1.3	0.05	20.637	0.8125	42.5	47.6
15118	15250X	15000	30.213	1.1895	3.5	0.14	63.500	2.5000	1.5	0.06	20.637	0.8125	42.5	47.6
15119	15250X	15000	30.213	1.1895	1.5	0.06	63.500	2.5000	1.5	0.06	20.637	0.8125	42.5	47.6
15120	15250X	15000	30.213	1.1895	0.8	0.03	63.500	2.5000	1.5	0.06	20.637	0.8125	42.5	47.6
14116	14274	14000	30.226	1.1900	0.8	0.03	69.012	2.7170	3.3	0.13	19.845	0.7813	46	54.5
14116	14276	14000	30.226	1.1900	0.8	0.03	69.012	2.7170	1.3	0.05	19.845	0.7813	46	54.5
14116	14277	14000	30.226	1.1900	0.8	0.03	69.012	2.7170	2.3	0.09	22.385	0.8813	46	54.5
443	432A	435	31.750	1.2500	0.8	0.03	95.250	3.7500	0.8	0.03	27.783	1.0938	104	123
2580	2520	2500	31.750	1.2500	0.8	0.03	66.421	2.6150	3.3	0.13	25.400	1.0000	69.4	81.8
2580	2523	2500	31.750	1.2500	0.8	0.03	69.850	2.7500	1.3	0.05	23.812	0.9375	69.4	81.8
3188	3120	3100	31.750	1.2500	0.8	0.03	72.626	2.8593	3.3	0.13	30.162	1.1875	78.1	88.3
3193	3120	3100	31.750	1.2500	3.5	0.14	72.626	2.8593	3.3	0.13	30.162	1.1875	78.1	88.3
3476	3420	3400	31.750	1.2500	1.3	0.05	79.375	3.1250	3.3	0.13	29.370	1.1563	86.7	104
02475	02420	02400	31.750	1.2500	3.5	0.14	68.262	2.6875	1.5	0.06	22.225	0.8750	61.6	82.5
02475	02421	02400	31.750	1.2500	3.5	0.14	68.262	2.6875	0.8	0.03	22.225	0.8750	61.6	82.5
02875	02820	02800	31.750	1.2500	3.5	0.14	73.025	2.8750	3.3	0.13	22.225	0.8750	55.9	67
08125	08231	08000	31.750	1.2500	1.0	0.04	58.738	2.3125	1.0	0.04	14.683	0.5781	27.2	31.6
14125A	14274	14000	31.750	1.2500	3.5	0.14	69.012	2.7170	3.3	0.13	19.845	0.7813	46	54.5
14125A	14276	14000	31.750	1.2500	3.5	0.14	69.012	2.7170	1.3	0.05	19.845	0.7813	46	54.5
14125A	14277	14000	31.750	1.2500	3.5	0.14	69.012	2.7170	2.3	0.09	22.385	0.8813	46	54.5
15123	15243	15000	31.750	1.2500	SP	SP	61.912	2.4375	2.0	0.08	18.161	0.7150	42.5	47.6
15125	15243	15000	31.750	1.2500	3.5	0.14	61.912	2.4375	2.0	0.08	19.050	0.7500	42.5	47.6
15126	15243	15000	31.750	1.2500	0.8	0.03	61.912	2.4375	2.0	0.08	19.050	0.7500	42.5	47.6
15123	15245	15000	31.750	1.2500	SP	SP	62.000	2.4409	1.3	0.05	18.161	0.7150	42.5	47.6
15125	15245	15000	31.750	1.2500	3.5	0.14	62.000	2.4409	1.3	0.05	19.050	0.7500	42.5	47.6
15126	15245	15000	31.750	1.2500	0.8	0.03	62.000	2.4409	1.3	0.05	19.050	0.7500	42.5	47.6
15123	15250	15000	31.750	1.2500	SP	SP	63.500	2.5000	1.3	0.05	18.161	0.7150	42.5	47.6
15125	15250	15000	31.750	1.2500	3.5	0.14	63.500	2.5000	1.3	0.05	20.637	0.8125	42.5	47.6
15126	15250	15000	31.750	1.2500	0.8	0.03	63.500	2.5000	1.3	0.05	20.637	0.8125	42.5	47.6
15123	15250X	15000	31.750	1.2500	SP	SP	63.500	2.5000	1.5	0.06	18.161	0.7150	42.5	47.6
15125	15250X	15000	31.750	1.2500	3.5	0.14	63.500	2.5000	1.5	0.06	20.637	0.8125	42.5	47.6

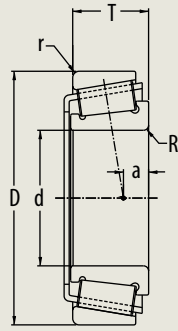

The tables include the most common industry series and sizes in the market. Additional industry series and sizes are available from PEER upon request.

Cone	Cup	Series	d		R		D		r		T		Basic Load Rating	
			Cone Bore		Max Shaft Radius		Cup Outer Diameter		Max Housing Radius		Total Width		Dynamic Cr	Static Cor
			mm	inch	mm	inch	mm	inch	mm	inch	mm	inch	KN	KN
15126	15250X	15000	31.750	1.2500	0.8	0.03	63.500	2.5000	1.5	0.06	20.637	0.8125	42.5	47.6
LM67048	LM67010	LM67000	31.750	1.2500	SP	SP	59.131	2.3280	1.3	0.05	15.875	0.6250	32.9	38.6
LM67049A	LM67010	LM67000	31.750	1.2500	0.8	0.03	59.131	2.3280	1.3	0.05	15.875	0.6250	32.9	38.6
HM88542	HM88510	HM88500	31.750	1.2500	1.3	0.05	73.025	2.8750	3.3	0.13	29.370	1.1563	72.4	97.3
HM89440	HM89410	HM89400	31.750	1.2500	0.8	0.03	76.200	3.0000	3.3	0.13	29.369	1.1563	76.4	102.6
HM89440	HM89411	HM89400	31.750	1.2500	0.8	0.03	76.200	3.0000	0.8	0.03	29.369	1.1563	76.4	102.6
2585	2520	2500	33.338	1.3125	3.5	0.14	66.421	2.6150	3.3	0.13	25.400	1.0000	69.4	81.8
2585	2523	2500	33.338	1.3125	3.5	0.14	69.850	2.7500	1.3	0.05	23.812	0.9375	69.4	81.8
2790	2720	2700	33.338	1.3125	1.5	0.06	76.200	3.0000	3.3	0.13	23.812	0.9375	71.6	88
2790	2729	2700	33.338	1.3125	1.5	0.06	76.200	3.0000	0.8	0.03	23.812	0.9375	71.6	88
2790	2735X	2700	33.338	1.3125	1.5	0.06	73.025	2.8750	0.8	0.03	23.812	0.9375	71.6	88
3196	3120	3100	33.338	1.3125	3.5	0.14	72.626	2.8593	3.3	0.13	30.162	1.1875	78.1	88.3
3483	3420	3400	33.338	1.3125	0.8	0.03	79.375	3.1250	3.3	0.13	29.370	1.1563	86.7	104
14131	14274	14000	33.338	1.3125	0.8	0.03	69.012	2.7170	3.3	0.13	19.845	0.7813	46	54.5
14131	14276	14000	33.338	1.3125	0.8	0.03	69.012	2.7170	1.3	0.05	19.845	0.7813	46	54.5
14131	14277	14000	33.338	1.3125	0.8	0.03	69.012	2.7170	2.3	0.09	22.385	0.8813	46	54.5
43131	43312	43000	33.338	1.3125	3.5	0.14	79.375	3.1250	1.5	0.06	25.400	1.0000	66.6	68.8
43132	43312	43000	33.338	1.3125	2.0	0.08	79.375	3.1250	1.5	0.06	25.400	1.0000	66.6	68.8
M88047	M88010	M88000	33.338	1.3125	5.5	0.22	68.262	2.6875	1.5	0.06	22.225	0.8750	53.5	67.3
M88048	M88010	M88000	33.338	1.3125	0.8	0.03	68.262	2.6875	1.5	0.06	22.225	0.8750	53.5	67.3
HM88547	HM88510	HM88500	33.338	1.3125	0.8	0.03	73.025	2.8750	3.3	0.13	29.370	1.1563	72.4	97.3
HM89443	HM89410	HM89400	33.338	1.3125	0.8	0.03	76.200	3.0000	3.3	0.13	29.369	1.1563	76.4	102.6
HM89443	HM89411	HM89400	33.338	1.3125	0.8	0.03	76.200	3.0000	0.8	0.03	29.369	1.1563	76.4	102.6
335	332	335	34.925	1.3750	0.8	0.03	80.000	3.1496	1.3	0.05	21.000	0.8268	65.1	70.8
335	332A	335	34.925	1.3750	0.8	0.03	80.000	3.1496	2.3	0.09	24.175	0.9518	65.1	70.8
2793	2720	2700	34.925	1.3750	0.8	0.03	76.200	3.0000	3.3	0.13	23.812	0.9375	71.6	88
2796	2720	2700	34.925	1.3750	3.5	0.14	76.200	3.0000	3.3	0.13	23.812	0.9375	71.6	88
2793	2729	2700	34.925	1.3750	0.8	0.03	76.200	3.0000	0.8	0.03	23.812	0.9375	71.6	88
2796	2729	2700	34.925	1.3750	3.5	0.14	76.200	3.0000	0.8	0.03	23.812	0.9375	71.6	88
2793	2735X	2700	34.925	1.3750	0.8	0.03	73.025	2.8750	0.8	0.03	23.812	0.9375	71.6	88
2796	2735X	2700	34.925	1.3750	3.5	0.14	73.025	2.8750	0.8	0.03	23.812	0.9375	71.6	88
3379	3320	3300	34.925	1.3750	3.5	0.14	80.167	3.1562	3.3	0.13	29.370	1.1563	94	111
3379	3325	3300	34.925	1.3750	3.5	0.14	79.974	3.1486	3.3	0.13	29.370	1.1563	94	111
3379	3331	3300	34.925	1.3750	3.5	0.14	80.167	3.1562	0.8	0.03	29.370	1.1563	94	111

INCH AND ISO METRIC SERIES | BY CONE BORE

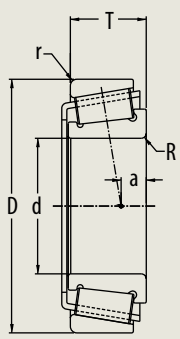

The tables include the most common industry series and sizes in the market. Additional industry series and sizes are available from PEER upon request.

Cone	Cup	Series	d		R		D		r		T		Basic Load Rating	
			Cone Bore		Max Shaft Radius		Cup Outer Diameter		Max Housing Radius		Total Width		Dynamic Cr	Static Cor
			mm	inch	mm	inch	mm	inch	mm	inch	mm	inch	KN	KN
3482	3420	3400	34.925	1.3750	0.8	0.03	79.375	3.1250	3.3	0.13	29.370	1.1563	86.7	104
3872	3820	3800	34.925	1.3750	3.5	0.14	85.725	3.3750	3.3	0.13	30.162	1.1875	101	127
3872A	3820	3800	34.925	1.3750	0.8	0.03	85.725	3.3750	3.3	0.13	30.162	1.1875	101	127
14137A	14274	14000	34.925	1.3750	1.5	0.06	69.012	2.7170	3.3	0.13	19.845	0.7813	46	54.5
14138A	14274	14000	34.925	1.3750	3.5	0.14	69.012	2.7170	3.3	0.13	19.845	0.7813	46	54.5
14137A	14276	14000	34.925	1.3750	1.5	0.06	69.012	2.7170	1.3	0.05	19.845	0.7813	46	54.5
14138A	14276	14000	34.925	1.3750	3.5	0.14	69.012	2.7170	1.3	0.05	19.845	0.7813	46	54.5
14137A	14277	14000	34.925	1.3750	1.5	0.06	69.012	2.7170	2.3	0.09	22.385	0.8813	46	54.5
14138A	14277	14000	34.925	1.3750	3.5	0.14	69.012	2.7170	2.3	0.09	22.385	0.8813	46	54.5
25877	25820	25800	34.925	1.3750	1.5	0.06	73.025	2.8750	2.3	0.09	23.812	0.9375	69	82.6
25878	25820	25800	34.925	1.3750	3.5	0.14	73.025	2.8750	2.3	0.09	23.812	0.9375	69	82.6
25877	25821	25800	34.925	1.3750	1.5	0.06	73.025	2.8750	0.8	0.03	23.812	0.9375	69	82.6
25878	25821	25800	34.925	1.3750	3.5	0.14	73.025	2.8750	0.8	0.03	23.812	0.9375	69	82.6
31593	31520	31500	34.925	1.3750	3.5	0.14	76.200	3.0000	3.3	0.13	29.370	1.1563	78.2	93.1
31594	31520	31500	34.925	1.3750	1.5	0.06	76.200	3.0000	3.3	0.13	29.370	1.1563	78.2	93.1
LM48548	LM48510	LM48500	34.925	1.3750	SP	SP	65.088	2.5625	1.3	0.05	18.034	0.7100	45.7	54.9
HM88649	HM88610	HM88600	34.925	1.3750	2.3	0.09	72.233	2.8438	2.3	0.09	25.400	1.0000	63.8	82.7
HM88649	HM88611	HM88600	34.925	1.3750	2.3	0.09	71.973	2.8336	1.5	0.06	27.000	1.0630	63.8	82.7
HM89446	HM89410	HM89400	34.925	1.3750	3.5	0.14	76.200	3.0000	3.3	0.13	29.369	1.1563	76.4	102.6
HM89446	HM89411	HM89400	34.925	1.3750	3.5	0.14	76.200	3.0000	0.8	0.03	29.369	1.1563	76.4	102.6
14139	14274	14000	34.976	1.3770	1.3	0.05	69.012	2.7170	3.3	0.13	19.845	0.7813	46	54.5
14139	14276	14000	34.976	1.3770	1.3	0.05	69.012	2.7170	1.3	0.05	19.845	0.7813	46	54.5
14139	14277	14000	34.976	1.3770	1.3	0.05	69.012	2.7170	2.3	0.09	22.385	0.8813	46	54.5
19138	19268	19000	34.976	1.3770	1.5	0.06	68.262	2.6875	1.5	0.06	15.875	0.6250	44.2	51
19138	19268x	19000	34.976	1.3770	1.5	0.06	68.275	2.6880	1.5	0.06	20.000	0.7874	44.2	51
19138	19281	19000	34.976	1.3770	1.5	0.06	71.438	2.8125	1.0	0.04	15.875	0.6250	44.2	51
L68149	L68110	L68100	34.988	1.3775	SP	SP	59.131	2.3280	1.3	0.05	15.875	0.6250	32.7	43.2
L68149	L68111	L68100	34.988	1.3775	SP	SP	59.974	2.3612	1.3	0.05	15.875	0.6250	32.7	43.2
LM78349	LM78310A	LM78300	34.988	1.3775	3.5	0.14	61.973	2.4399	1.5	0.06	16.700	0.6575	37.3	48.5
339	332	335	35.000	1.3780	0.8	0.03	80.000	3.1496	1.3	0.05	21.000	0.8268	65.1	70.8
339	332A	335	35.000	1.3780	0.8	0.03	80.000	3.1496	2.3	0.09	24.175	0.9518	65.1	70.8
26883	26820	26800	35.000	1.3780	0.8	0.03	80.167	3.1562	3.3	0.13	25.400	1.0000	74.7	94.4
26883	26821	26800	35.000	1.3780	0.8	0.03	80.167	3.1562	3.3	0.13	29.370	1.1563	74.7	94.4
26883	26822	26800	35.000	1.3780	0.8	0.03	79.375	3.1250	0.8	0.03	23.812	0.9375	74.7	94.4

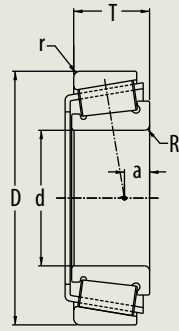

The tables include the most common industry series and sizes in the market. Additional industry series and sizes are available from PEER upon request.

Cone	Cup	Series	d		R		D		r		T		Basic Load Rating	
			Cone Bore		Max Shaft Radius		Cup Outer Diameter		Max Housing Radius		Total Width		Dynamic Cr	Static Cor
			mm	inch	mm	inch	mm	inch	mm	inch	mm	inch	KN	KN
26883	26823	26800	35.000	1.3780	0.8	0.03	76.200	3.0000	1.5	0.06	25.400	1.0000	74.7	94.4
26883	26830	26800	35.000	1.3780	0.8	0.03	80.167	3.1562	0.8	0.03	25.400	1.0000	74.7	94.4
X30207	Y30207	30207	35.000	1.3780	1.5	0.06	72.000	2.8346	1.5	0.06	18.250	0.7185	52.9	57.9
X30307	Y30307	30307	35.000	1.3780	2.0	0.08	80.000	3.1496	1.5	0.06	22.750	0.8957	74.6	76.9
X31307	Y31307	31307	35.000	1.3780	2.0	0.08	80.000	3.1496	1.5	0.06	22.750	0.8957	64.3	70.3
X32007X	Y32007X	32007X	35.000	1.3780	1.0	0.04	62.000	2.4409	1.0	0.04	18.000	0.7087	41.2	55.7
X32207	Y32207	32207	35.000	1.3780	1.5	0.06	72.000	2.8346	1.5	0.06	24.250	0.9547	70.5	84.1
X32307	Y32307	32307	35.000	1.3780	2.0	0.08	80.000	3.1496	1.5	0.06	32.750	1.2894	99.1	112
X32307B	Y32307B	32307B	35.000	1.3780	2.0	0.08	80.000	3.1496	1.5	0.06	32.750	1.2894	95.9	117
X33207	Y33207	33207	35.000	1.3780	1.5	0.06	72.000	2.8346	1.5	0.06	28.000	1.1024	79.3	96.5
HM88648	HM88610	HM88600	35.717	1.4062	3.5	0.14	72.233	2.8438	2.3	0.09	25.400	1.0000	63.8	82.7
HM88648	HM88611	HM88600	35.717	1.4062	3.5	0.14	71.973	2.8336	1.5	0.06	27.000	1.0630	63.8	82.7
2780	2720	2700	36.487	1.4365	1.5	0.06	76.200	3.0000	3.3	0.13	23.812	0.9375	71.6	88
2794	2720	2700	36.487	1.4365	3.5	0.14	76.200	3.0000	3.3	0.13	23.812	0.9375	71.6	88
2780	2729	2700	36.487	1.4365	1.5	0.06	76.200	3.0000	0.8	0.03	23.812	0.9375	71.6	88
2794	2729	2700	36.487	1.4365	3.5	0.14	76.200	3.0000	0.8	0.03	23.812	0.9375	71.6	88
2780	2735X	2700	36.487	1.4365	1.5	0.06	73.025	2.8750	0.8	0.03	23.812	0.9375	71.6	88
2794	2735X	2700	36.487	1.4365	3.5	0.14	73.025	2.8750	0.8	0.03	23.812	0.9375	71.6	88
25880	25820	25800	36.487	1.4365	1.5	0.06	73.025	2.8750	2.3	0.09	23.812	0.9375	69	82.6
25880	25821	25800	36.487	1.4365	1.5	0.06	73.025	2.8750	0.8	0.03	23.812	0.9375	69	82.6
3479	3420	3400	36.512	1.4375	0.8	0.03	79.375	3.1250	3.3	0.13	29.370	1.1563	86.7	104
31597	31520	31500	36.512	1.4375	3.5	0.14	76.200	3.0000	3.3	0.13	29.370	1.1563	78.2	93.1
46143	46368	46000	36.512	1.4375	1.5	0.06	93.662	3.6875	3.3	0.13	31.750	1.2500	107	137
HM89249	HM89210	HM89200	36.512	1.4375	3.5	0.14	79.375	3.1250	3.3	0.13	29.370	1.1563	85.8	103
HM89448	HM89410	HM89400	36.512	1.4375	0.8	0.03	76.200	3.0000	3.3	0.13	29.369	1.1563	76.4	102.6
HM89449	HM89410	HM89400	36.512	1.4375	3.5	0.14	76.200	3.0000	3.3	0.13	29.369	1.1563	76.4	102.6
HM89448	HM89411	HM89400	36.512	1.4375	0.8	0.03	76.200	3.0000	0.8	0.03	29.369	1.1563	76.4	102.6
HM89449	HM89411	HM89400	36.512	1.4375	3.5	0.14	76.200	3.0000	0.8	0.03	29.369	1.1563	76.4	102.6
JL69349	JL69310	L69300	38.000	1.4961	SP	SP	63.000	2.4803	1.5	0.06	17.000	0.6693	36.3	48.3
JL69349	JL69310P	L69300	38.000	1.4961	SP	SP	63.000	2.4803	1.5	0.06	17.000	0.6693	36.3	48.3
418	414	415	38.100	1.5000	3.5	0.14	88.500	3.4843	1.5	0.06	26.988	1.0625	94.3	106
2776	2720	2700	38.100	1.5000	4.3	0.17	76.200	3.0000	3.3	0.13	23.812	0.9375	71.6	88
2788	2720	2700	38.100	1.5000	3.5	0.14	76.200	3.0000	3.3	0.13	23.812	0.9375	71.6	88
2776	2729	2700	38.100	1.5000	4.3	0.17	76.200	3.0000	0.8	0.03	23.812	0.9375	71.6	88

INCH AND ISO METRIC SERIES | BY CONE BORE

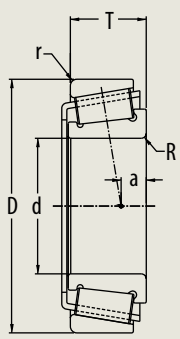

The tables include the most common industry series and sizes in the market. Additional industry series and sizes are available from PEER upon request.

Cone	Cup	Series	d		R		D		r		T		Basic Load Rating	
			Cone Bore		Max Shaft Radius		Cup Outer Diameter		Max Housing Radius		Total Width		Dynamic Cr	Static Cor
			mm	inch	mm	inch	mm	inch	mm	inch	mm	inch	KN	KN
2788	2729	2700	38.100	1.5000	3.5	0.14	76.200	3.0000	0.8	0.03	23.812	0.9375	71.6	88
2776	2735X	2700	38.100	1.5000	4.3	0.17	73.025	2.8750	0.8	0.03	23.812	0.9375	71.6	88
2788	2735X	2700	38.100	1.5000	3.5	0.14	73.025	2.8750	0.8	0.03	23.812	0.9375	71.6	88
3490	3420	3400	38.100	1.5000	3.5	0.14	79.375	3.1250	3.3	0.13	29.370	1.1563	86.7	104
3580	3520	3500	38.100	1.5000	1.5	0.06	84.138	3.3125	3.3	0.13	30.162	1.1875	93.4	116
3580	3525	3500	38.100	1.5000	1.5	0.06	87.312	3.4375	3.3	0.13	30.162	1.1875	93.4	116
13685	13620	13600	38.100	1.5000	3.5	0.14	69.012	2.7170	0.8	0.03	19.050	0.7500	46.8	57.9
13687	13620	13600	38.100	1.5000	2.0	0.08	69.012	2.7170	0.8	0.03	19.050	0.7500	46.8	57.9
13685	13621	13600	38.100	1.5000	3.5	0.14	69.012	2.7170	2.3	0.09	19.050	0.7500	46.8	57.9
13687	13621	13600	38.100	1.5000	2.0	0.08	69.012	2.7170	2.3	0.09	19.050	0.7500	46.8	57.9
16150	16282	16000	38.100	1.5000	3.5	0.14	72.000	2.8346	1.5	0.06	19.000	0.7480	47.4	57.4
16150	16284	16000	38.100	1.5000	3.5	0.14	72.238	2.8440	1.3	0.05	20.638	0.8125	47.4	57.4
19150	19268	19000	38.100	1.5000	1.5	0.06	68.262	2.6875	1.5	0.06	15.875	0.6250	44.2	51
19150	19268x	19000	38.100	1.5000	1.5	0.06	68.275	2.6880	1.5	0.06	20.000	0.7874	44.2	51
19150	19281	19000	38.100	1.5000	1.5	0.06	71.438	2.8125	1.0	0.04	15.875	0.6250	44.2	51
26878	26820	26800	38.100	1.5000	0.8	0.03	80.167	3.1562	3.3	0.13	25.400	1.0000	74.7	94.4
26878	26821	26800	38.100	1.5000	0.8	0.03	80.167	3.1562	3.3	0.13	29.370	1.1563	74.7	94.4
26878	26822	26800	38.100	1.5000	0.8	0.03	79.375	3.1250	0.8	0.03	23.812	0.9375	74.7	94.4
26878	26823	26800	38.100	1.5000	0.8	0.03	76.200	3.0000	1.5	0.06	25.400	1.0000	74.7	94.4
26878	26830	26800	38.100	1.5000	0.8	0.03	80.167	3.1562	0.8	0.03	25.400	1.0000	74.7	94.4
27881	27820	27800	38.100	1.5000	3.5	0.14	80.035	3.1510	1.5	0.06	24.608	0.9688	69.7	86
28150	28300	28000	38.100	1.5000	1.5	0.06	76.200	3.0000	1.3	0.05	20.637	0.8125	53.6	60.5
LM29748	LM29710	LM29700	38.100	1.5000	SP	SP	65.088	2.5625	1.3	0.05	18.034	0.7100	40.9	52.9
LM29749	LM29710	LM29700	38.100	1.5000	2.3	0.09	65.088	2.5625	1.3	0.05	18.034	0.7100	40.9	52.9
33880	33821	33800	38.100	1.5000	3.5	0.14	95.250	3.7500	2.3	0.09	27.783	1.0938	106	138
33880	33822	33800	38.100	1.5000	3.5	0.14	95.250	3.7500	0.8	0.03	27.783	1.0938	106	138
620	612	615	39.688	1.5625	0.8	0.03	120.650	4.7500	3.3	0.13	41.275	1.6250	170	210
2789	2720	2700	39.688	1.5625	3.5	0.14	76.200	3.0000	3.3	0.13	23.812	0.9375	71.6	88
2789	2729	2700	39.688	1.5625	3.5	0.14	76.200	3.0000	0.8	0.03	23.812	0.9375	71.6	88
2789	2735X	2700	39.688	1.5625	3.5	0.14	73.025	2.8750	0.8	0.03	23.812	0.9375	71.6	88
3386	3320	3300	39.688	1.5625	0.8	0.03	80.167	3.1562	3.3	0.13	29.370	1.1563	94	111
3386	3325	3300	39.688	1.5625	0.8	0.03	79.974	3.1486	3.3	0.13	29.370	1.1563	94	111
3386	3331	3300	39.688	1.5625	0.8	0.03	80.167	3.1562	0.8	0.03	29.370	1.1563	94	111
26881	26820	26800	39.688	1.5625	3.5	0.14	80.167	3.1562	3.3	0.13	25.400	1.0000	74.7	94.4

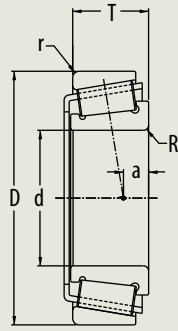

The tables include the most common industry series and sizes in the market. Additional industry series and sizes are available from PEER upon request.

Cone	Cup	Series	d		R		D		r		T		Basic Load Rating	
			Cone Bore		Max Shaft Radius		Cup Outer Diameter		Max Housing Radius		Total Width		Dynamic Cr	Static Cor
			mm	inch	mm	inch	mm	inch	mm	inch	mm	inch	KN	KN
26881	26821	26800	39.688	1.5625	3.5	0.14	80.167	3.1562	3.3	0.13	29.370	1.1563	74.7	94.4
26881	26822	26800	39.688	1.5625	3.5	0.14	79.375	3.1250	0.8	0.03	23.812	0.9375	74.7	94.4
26881	26823	26800	39.688	1.5625	3.5	0.14	76.200	3.0000	1.5	0.06	25.400	1.0000	74.7	94.4
26881	26830	26800	39.688	1.5625	3.5	0.14	80.167	3.1562	0.8	0.03	25.400	1.0000	74.7	94.4
344	332	335	40.000	1.5748	3.5	0.14	80.000	3.1496	1.3	0.05	21.000	0.8268	65.1	70.8
344A	332	335	40.000	1.5748	0.8	0.03	80.000	3.1496	1.3	0.05	21.000	0.8268	65.1	70.8
344	332A	335	40.000	1.5748	3.5	0.14	80.000	3.1496	2.3	0.09	24.175	0.9518	65.1	70.8
344A	332A	335	40.000	1.5748	0.8	0.03	80.000	3.1496	2.3	0.09	24.175	0.9518	65.1	70.8
350A	352	355	40.000	1.5748	0.8	0.03	90.119	3.5480	2.3	0.09	23.000	0.9055	67.1	75.6
350A	354A	355	40.000	1.5748	0.8	0.03	85.000	3.3465	1.3	0.05	20.635	0.8124	67.1	75.6
350A	354X	355	40.000	1.5748	0.8	0.03	85.000	3.3465	1.5	0.06	20.635	0.8124	67.1	75.6
420	414	415	40.000	1.5748	3.5	0.14	88.500	3.4843	1.5	0.06	26.988	1.0625	94.3	106
543	532A	535	40.000	1.5748	3.5	0.14	111.125	4.3750	3.3	0.13	38.100	1.5000	140	176
543	532X	535	40.000	1.5748	3.5	0.14	107.950	4.2500	3.3	0.13	36.513	1.4375	140	176
X30208	Y30208	30208	40.000	1.5748	1.5	0.06	80.000	3.1496	1.5	0.06	19.750	0.7776	62.6	69
X30308	Y30308	30308	40.000	1.5748	2.0	0.08	90.000	3.5433	1.5	0.06	25.250	0.9941	89.6	99.4
X31308	Y31308	31308	40.000	1.5748	2.0	0.08	90.000	3.5433	1.5	0.06	25.250	0.9941	79.3	87.8
X32008X	Y32008X	32008X	40.000	1.5748	1.0	0.04	68.000	2.6772	1.0	0.04	19.000	0.7480	49.4	66.6
X32208	Y32208	32208	40.000	1.5748	1.5	0.06	80.000	3.1496	1.5	0.06	24.750	0.9744	78.5	92.3
X32308	Y32308	32308	40.000	1.5748	2.0	0.08	90.000	3.5433	1.5	0.06	35.250	1.3878	116	140
X32308B	Y32308B	32308B	40.000	1.5748	2.0	0.08	90.000	3.5433	1.5	0.06	35.250	1.3878	106	137
X33108	Y33108	33108	40.000	1.5748	1.5	0.06	75.000	2.9528	1.5	0.06	26.000	1.0236	81	104
X33208	Y33208	33208	40.000	1.5748	1.5	0.06	80.000	3.1496	1.5	0.06	32.000	1.2598	103	130
LM300849	LM300811	LM300800	40.988	1.6137	SP	SP	67.975	2.6762	1.5	0.06	17.502	0.6891	42	59.8
336	332	335	41.275	1.6250	0.8	0.03	80.000	3.1496	1.3	0.05	21.000	0.8268	65.1	70.8
342	332	335	41.275	1.6250	3.5	0.14	80.000	3.1496	1.3	0.05	21.000	0.8268	65.1	70.8
342A	332	335	41.275	1.6250	3.5	0.14	80.000	3.1496	1.3	0.05	28.574	1.1250	65.1	70.8
336	332A	335	41.275	1.6250	0.8	0.03	80.000	3.1496	2.3	0.09	24.175	0.9518	65.1	70.8
342	332A	335	41.275	1.6250	3.5	0.14	80.000	3.1496	2.3	0.09	24.175	0.9518	65.1	70.8
342A	332A	335	41.275	1.6250	3.5	0.14	80.000	3.1496	2.3	0.09	31.749	1.2500	65.1	70.8
526	522	525	41.275	1.6250	3.5	0.14	101.600	4.0000	3.3	0.13	34.925	1.3750	135	164
3384	3320	3300	41.275	1.6250	0.8	0.03	80.167	3.1562	3.3	0.13	29.370	1.1563	94	111
3384	3325	3300	41.275	1.6250	0.8	0.03	79.974	3.1486	3.3	0.13	29.370	1.1563	94	111
3384	3331	3300	41.275	1.6250	0.8	0.03	80.167	3.1562	0.8	0.03	29.370	1.1563	94	111

INCH AND ISO METRIC SERIES | BY CONE BORE

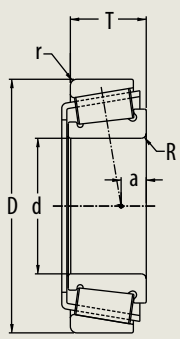

The tables include the most common industry series and sizes in the market. Additional industry series and sizes are available from PEER upon request.

Cone	Cup	Series	d		R		D		r		T		Basic Load Rating	
			Cone Bore		Max Shaft Radius		Cup Outer Diameter		Max Housing Radius		Total Width		Dynamic Cr	Static Cor
			mm	inch	mm	inch	mm	inch	mm	inch	mm	inch	KN	KN
3585	3520	3500	41.275	1.6250	1.5	0.06	84.138	3.3125	3.3	0.13	30.162	1.1875	93.4	116
3585	3525	3500	41.275	1.6250	1.5	0.06	87.312	3.4375	3.3	0.13	30.162	1.1875	93.4	116
3877	3820	3800	41.275	1.6250	3.5	0.14	85.725	3.3750	3.3	0.13	30.162	1.1875	101	127
3880	3820	3800	41.275	1.6250	0.8	0.03	85.725	3.3750	3.3	0.13	30.162	1.1875	101	127
4388	4335	4300	41.275	1.6250	3.5	0.14	90.488	3.5625	3.3	0.13	39.687	1.5625	129	163
11162	11300	11000	41.275	1.6250	1.5	0.06	76.200	3.0000	1.5	0.06	18.009	0.7090	48.3	57.9
18590	18520	18500	41.275	1.6250	3.5	0.14	73.025	2.8750	1.5	0.06	16.667	0.6562	43	51.2
24780	24720	24700	41.275	1.6250	3.5	0.14	76.200	3.0000	0.8	0.03	22.225	0.8750	62.9	77.8
24780	24721	24700	41.275	1.6250	3.5	0.14	76.200	3.0000	2.3	0.09	25.400	1.0000	62.9	77.8
24780	24722	24700	41.275	1.6250	3.5	0.14	76.200	3.0000	3.3	0.13	22.225	0.8750	62.9	77.8
26882	26820	26800	41.275	1.6250	3.5	0.14	80.167	3.1562	3.3	0.13	25.400	1.0000	74.7	94.4
26882	26821	26800	41.275	1.6250	3.5	0.14	80.167	3.1562	3.3	0.13	29.370	1.1563	74.7	94.4
26882	26822	26800	41.275	1.6250	3.5	0.14	79.375	3.1250	0.8	0.03	23.812	0.9375	74.7	94.4
26882	26823	26800	41.275	1.6250	3.5	0.14	76.200	3.0000	1.5	0.06	25.400	1.0000	74.7	94.4
26882	26830	26800	41.275	1.6250	3.5	0.14	80.167	3.1562	0.8	0.03	25.400	1.0000	74.7	94.4
44162	44348	44000	41.275	1.6250	2.3	0.09	88.500	3.4843	1.5	0.06	25.400	1.0000	71.8	79.5
46162	46368	46000	41.275	1.6250	0.8	0.03	93.662	3.6875	3.3	0.13	31.750	1.2500	107	137
59162	59412	59000	41.275	1.6250	1.5	0.06	104.775	4.1250	3.3	0.13	36.512	1.4375	139	191
LM501349	LM501310	LM501300	41.275	1.6250	3.5	0.14	73.431	2.8910	0.8	0.03	19.558	0.7700	52.4	63.8
HM801346	HM801310	HM801300	41.275	1.6250	0.8	0.03	82.550	3.2500	3.3	0.13	29.370	1.1563	84.8	112
M802048	M802011	M802000	41.275	1.6250	3.5	0.14	82.550	3.2500	3.3	0.13	26.543	1.0450	76.3	95
HM803145	HM803110	HM803100	41.275	1.6250	0.8	0.03	88.900	3.5000	3.3	0.13	30.162	1.1875	97.2	131
HM803146	HM803110	HM803100	41.275	1.6250	3.5	0.14	88.900	3.5000	3.3	0.13	30.162	1.1875	97.2	131
HM804840	HM804810	HM804800	41.275	1.6250	3.5	0.14	95.250	3.7500	3.3	0.13	30.162	1.1875	107	145
HM807035	HM807010	HM807000	41.275	1.6250	1.5	0.06	104.775	4.1250	3.3	0.13	36.512	1.4375	151	210
HM807035	JHM807012	HM807000	41.275	1.6250	1.5	0.06	105.000	4.1339	2.5	0.10	36.873	1.4517	151	210
461	453	455	42.850	1.6870	0.8	0.03	107.950	4.2500	0.8	0.03	27.795	1.0943	113	145
461	453A	455	42.850	1.6870	0.8	0.03	107.950	4.2500	0.8	0.03	27.782	1.0938	113	145
461	453X	455	42.850	1.6870	0.8	0.03	104.775	4.1250	3.3	0.13	30.162	1.1875	113	145
461	454	455	42.850	1.6870	0.8	0.03	110.000	4.3307	2.0	0.08	27.795	1.0943	113	145
25578	25519	25500	42.862	1.6875	2.3	0.09	82.550	3.2500	2.0	0.08	23.812	0.9375	74.8	95.7
25578	25520	25500	42.862	1.6875	2.3	0.09	82.931	3.2650	0.8	0.03	23.812	0.9375	74.8	95.7
25578	25521	25500	42.862	1.6875	2.3	0.09	83.058	3.2700	3.3	0.13	23.812	0.9375	74.8	95.7
25578	25522	25500	42.862	1.6875	2.3	0.09	83.058	3.2700	2.0	0.08	23.876	0.9400	74.8	95.7

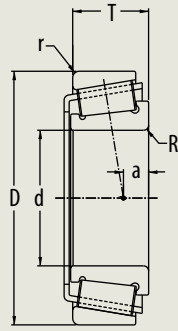

The tables include the most common industry series and sizes in the market. Additional industry series and sizes are available from PEER upon request.

Cone	Cup	Series	d		R		D		r		T		Basic Load Rating	
			Cone Bore		Max Shaft Radius		Cup Outer Diameter		Max Housing Radius		Total Width		Dynamic Cr	Static Cor
			mm	inch	mm	inch	mm	inch	mm	inch	mm	inch	KN	KN
25578	25523	25500	42.862	1.6875	2.3	0.09	82.931	3.2650	2.3	0.09	26.988	1.0625	74.8	95.7
25578	25526	25500	42.862	1.6875	2.3	0.09	85.000	3.3465	2.3	0.09	23.812	0.9375	74.8	95.7
342-S	332	335	42.875	1.6880	3.5	0.14	80.000	3.1496	1.3	0.05	21.000	0.8268	65.1	70.8
342-S	332A	335	42.875	1.6880	3.5	0.14	80.000	3.1496	2.3	0.09	24.175	0.9518	65.1	70.8
25577	25519	25500	42.875	1.6880	3.5	0.14	82.550	3.2500	2.0	0.08	23.812	0.9375	74.8	95.7
25577	25520	25500	42.875	1.6880	3.5	0.14	82.931	3.2650	0.8	0.03	23.812	0.9375	74.8	95.7
25577	25521	25500	42.875	1.6880	3.5	0.14	83.058	3.2700	3.3	0.13	23.812	0.9375	74.8	95.7
25577	25522	25500	42.875	1.6880	3.5	0.14	83.058	3.2700	2.0	0.08	23.876	0.9400	74.8	95.7
25577	25523	25500	42.875	1.6880	3.5	0.14	82.931	3.2650	2.3	0.09	26.988	1.0625	74.8	95.7
25577	25526	25500	42.875	1.6880	3.5	0.14	85.000	3.3465	2.3	0.09	23.812	0.9375	74.8	95.7
26884	26820	26800	42.875	1.6880	3.5	0.14	80.167	3.1562	3.3	0.13	25.400	1.0000	74.7	94.4
26886	26820	26800	42.875	1.6880	1.5	0.06	80.167	3.1562	3.3	0.13	25.400	1.0000	74.7	94.4
26884	26821	26800	42.875	1.6880	3.5	0.14	80.167	3.1562	3.3	0.13	29.370	1.1563	74.7	94.4
26886	26821	26800	42.875	1.6880	1.5	0.06	80.167	3.1562	3.3	0.13	29.370	1.1563	74.7	94.4
26884	26822	26800	42.875	1.6880	3.5	0.14	79.375	3.1250	0.8	0.03	23.812	0.9375	74.7	94.4
26886	26822	26800	42.875	1.6880	1.5	0.06	79.375	3.1250	0.8	0.03	23.812	0.9375	74.7	94.4
26884	26823	26800	42.875	1.6880	3.5	0.14	76.200	3.0000	1.5	0.06	25.400	1.0000	74.7	94.4
26886	26823	26800	42.875	1.6880	1.5	0.06	76.200	3.0000	1.5	0.06	25.400	1.0000	74.7	94.4
26884	26830	26800	42.875	1.6880	3.5	0.14	80.167	3.1562	0.8	0.03	25.400	1.0000	74.7	94.4
26886	26830	26800	42.875	1.6880	1.5	0.06	80.167	3.1562	0.8	0.03	25.400	1.0000	74.7	94.4
355	352	355	44.450	1.7500	2.3	0.09	90.119	3.5480	2.3	0.09	23.000	0.9055	67.1	75.6
355X	352	355	44.450	1.7500	3.5	0.14	90.119	3.5480	2.3	0.09	23.000	0.9055	67.1	75.6
355	354A	355	44.450	1.7500	2.3	0.09	85.000	3.3465	1.3	0.05	20.635	0.8124	67.1	75.6
355X	354A	355	44.450	1.7500	3.5	0.14	85.000	3.3465	1.3	0.05	20.635	0.8124	67.1	75.6
355	354X	355	44.450	1.7500	2.3	0.09	85.000	3.3465	1.5	0.06	20.635	0.8124	67.1	75.6
355X	354X	355	44.450	1.7500	3.5	0.14	85.000	3.3465	1.5	0.06	20.635	0.8124	67.1	75.6
438	432A	435	44.450	1.7500	3.5	0.14	95.250	3.7500	0.8	0.03	27.783	1.0938	104	123
460	453	455	44.450	1.7500	3.5	0.14	107.950	4.2500	0.8	0.03	27.795	1.0943	113	145
460	453A	455	44.450	1.7500	3.5	0.14	107.950	4.2500	0.8	0.03	27.782	1.0938	113	145
460	453X	455	44.450	1.7500	3.5	0.14	104.775	4.1250	3.3	0.13	30.162	1.1875	113	145
460	454	455	44.450	1.7500	3.5	0.14	110.000	4.3307	2.0	0.08	27.795	1.0943	113	145
527	522	525	44.450	1.7500	3.5	0.14	101.600	4.0000	3.3	0.13	34.925	1.3750	135	164
535	532A	535	44.450	1.7500	3.5	0.14	111.125	4.3750	3.3	0.13	38.100	1.5000	140	176
535	532X	535	44.450	1.7500	3.5	0.14	107.950	4.2500	3.3	0.13	36.513	1.4375	140	176

INCH AND ISO METRIC SERIES | BY CONE BORE

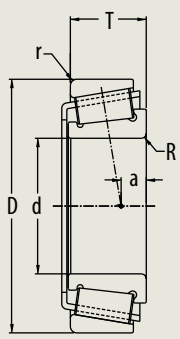

The tables include the most common industry series and sizes in the market. Additional industry series and sizes are available from PEER upon request.

Cone	Cup	Series	d		R		D		r		T		Basic Load Rating	
			Cone Bore		Max Shaft Radius		Cup Outer Diameter		Max Housing Radius		Total Width		Dynamic Cr	Static Cor
			mm	inch	mm	inch	mm	inch	mm	inch	mm	inch	KN	KN
3578	3520	3500	44.450	1.7500	3.5	0.14	84.138	3.3125	3.3	0.13	30.162	1.1875	93.4	116
3578A	3520	3500	44.450	1.7500	5.5	0.22	84.138	3.3125	3.3	0.13	30.162	1.1875	93.4	116
3578	3525	3500	44.450	1.7500	3.5	0.14	87.312	3.4375	3.3	0.13	30.162	1.1875	93.4	116
3578A	3525	3500	44.450	1.7500	5.5	0.22	87.312	3.4375	3.3	0.13	30.162	1.1875	93.4	116
3782	3720	3700	44.450	1.7500	3.5	0.14	93.264	3.6718	3.3	0.13	30.162	1.1875	101	133
3783	3720	3700	44.450	1.7500	6.4	0.25	93.264	3.6718	3.3	0.13	30.162	1.1875	101	133
3782	3730	3700	44.450	1.7500	3.5	0.14	93.264	3.6718	0.8	0.03	30.162	1.1875	101	133
3783	3730	3700	44.450	1.7500	6.4	0.25	93.264	3.6718	0.8	0.03	30.162	1.1875	101	133
12175	12303	12000	44.450	1.7500	1.5	0.06	76.992	3.0312	1.5	0.06	17.464	0.6876	42.6	52.2
18685	18620	18600	44.450	1.7500	2.8	0.11	79.375	3.1250	1.5	0.06	17.462	0.6875	44.2	54.3
25580	25519	25500	44.450	1.7500	3.5	0.14	82.550	3.2500	2.0	0.08	23.812	0.9375	74.8	95.7
25580	25520	25500	44.450	1.7500	3.5	0.14	82.931	3.2650	0.8	0.03	23.812	0.9375	74.8	95.7
25580	25521	25500	44.450	1.7500	3.5	0.14	83.058	3.2700	3.3	0.13	23.812	0.9375	74.8	95.7
25580	25522	25500	44.450	1.7500	3.5	0.14	83.058	3.2700	2.0	0.08	23.876	0.9400	74.8	95.7
25580	25523	25500	44.450	1.7500	3.5	0.14	82.931	3.2650	2.3	0.09	26.988	1.0625	74.8	95.7
25580	25526	25500	44.450	1.7500	3.5	0.14	85.000	3.3465	2.3	0.09	23.812	0.9375	74.8	95.7
45280	45220	45200	44.450	1.7500	0.8	0.03	104.775	4.1250	3.3	0.13	30.162	1.1875	126	163
45280	45221	45200	44.450	1.7500	0.8	0.03	104.775	4.1250	0.8	0.03	30.162	1.1875	126	163
46176	46368	46000	44.450	1.7500	3.5	0.14	93.662	3.6875	3.3	0.13	31.750	1.2500	107	137
49175	49368	49000	44.450	1.7500	3.5	0.14	93.662	3.6875	3.3	0.13	31.750	1.2500	111	134
53178	53375	53000	44.450	1.7500	2.0	0.08	95.250	3.7500	0.8	0.03	30.958	1.2188	83.8	91.7
55175C	55437	55000C	44.450	1.7500	3.5	0.14	111.125	4.3750	3.3	0.13	30.162	1.1875	111	150
55175C	55443	55000C	44.450	1.7500	3.5	0.14	112.712	4.4375	3.3	0.13	30.162	1.1875	111	150
65385	65320	65300	44.450	1.7500	3.5	0.14	114.300	4.5000	3.3	0.13	44.450	1.7500	184	222
HM803149	HM803110	HM803100	44.450	1.7500	3.5	0.14	88.900	3.5000	3.3	0.13	30.162	1.1875	97.2	131
HM807040	HM807010	HM807000	44.450	1.7500	3.5	0.14	104.775	4.1250	3.3	0.13	36.512	1.4375	151	210
HM807040	JHM807012	HM807000	44.450	1.7500	3.5	0.14	105.000	4.1339	2.5	0.10	36.873	1.4517	151	210
HM903249	HM903210	HM903200	44.450	1.7500	3.5	0.14	95.250	3.7500	0.8	0.03	30.958	1.2188	97.8	119
3776	3720	3700	44.983	1.7710	3.5	0.14	93.264	3.6718	3.3	0.13	30.162	1.1875	101	133
3776	3730	3700	44.983	1.7710	3.5	0.14	93.264	3.6718	0.8	0.03	30.162	1.1875	101	133
25584	25519	25500	44.983	1.7710	1.5	0.06	82.550	3.2500	2.0	0.08	23.812	0.9375	74.8	95.7
25584	25520	25500	44.983	1.7710	1.5	0.06	82.931	3.2650	0.8	0.03	23.812	0.9375	74.8	95.7
25584	25521	25500	44.983	1.7710	1.5	0.06	83.058	3.2700	3.3	0.13	23.812	0.9375	74.8	95.7
25584	25522	25500	44.983	1.7710	1.5	0.06	83.058	3.2700	2.0	0.08	23.876	0.9400	74.8	95.7

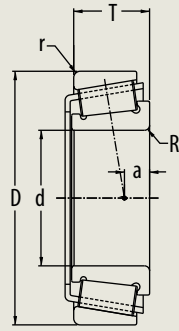

The tables include the most common industry series and sizes in the market. Additional industry series and sizes are available from PEER upon request.

Cone	Cup	Series	d		R		D		r		T		Basic Load Rating	
			Cone Bore		Max Shaft Radius		Cup Outer Diameter		Max Housing Radius		Total Width		Dynamic Cr	Static Cor
			mm	inch	mm	inch	mm	inch	mm	inch	mm	inch	KN	KN
25584	25523	25500	44.983	1.7710	1.5	0.06	82.931	3.2650	2.3	0.09	26.988	1.0625	74.8	95.7
25584	25526	25500	44.983	1.7710	1.5	0.06	85.000	3.3465	2.3	0.09	23.812	0.9375	74.8	95.7
X30209	Y30209	30209	45.000	1.7717	1.5	0.06	85.000	3.3465	1.5	0.06	20.750	0.8169	67.7	78.3
X30309	Y30309	30309	45.000	1.7717	2.0	0.08	100.000	3.9370	1.5	0.06	27.250	1.0728	108	121
X31309	Y31309	31309	45.000	1.7717	2.0	0.08	100.000	3.9370	1.5	0.06	27.250	1.0728	94	105
X32009X	Y32009X	32009X	45.000	1.7717	1.0	0.04	75.000	2.9528	1.0	0.04	20.000	0.7874	55.8	76.9
X32209	Y32209	32209	45.000	1.7717	1.5	0.06	85.000	3.3465	1.5	0.06	24.750	0.9744	81.2	98.9
X32309	Y32309	32309	45.000	1.7717	2.0	0.08	100.000	3.9370	1.5	0.06	38.250	1.5059	146	180
X32309B	Y32309B	32309B	45.000	1.7717	2.0	0.08	100.000	3.9370	1.5	0.06	38.250	1.5059	138	177
X33109	Y33109	33109	45.000	1.7717	1.5	0.06	80.000	3.1496	1.5	0.06	26.000	1.0236	83.3	111
X33209	Y33209	33209	45.000	1.7717	1.5	0.06	85.000	3.3465	1.5	0.06	32.000	1.2598	106	140
17887	17831	17800	45.230	1.7807	2.0	0.08	79.985	3.1490	1.3	0.05	19.842	0.7812	51.4	64.4
3586	3520	3500	45.237	1.7810	3.5	0.14	84.138	3.3125	3.3	0.13	30.162	1.1875	93.4	116
3586	3525	3500	45.237	1.7810	3.5	0.14	87.312	3.4375	3.3	0.13	30.162	1.1875	93.4	116
LM102949	LM102910	LM102900	45.242	1.7812	3.5	0.14	73.431	2.8910	0.8	0.03	19.558	0.7700	53.3	73.4
LM603049	LM603011	LM603000	45.242	1.7812	3.5	0.14	77.788	3.0625	0.8	0.03	19.842	0.7812	53.8	67.7
LM603049	LM603012	LM603000	45.242	1.7812	3.5	0.14	77.788	3.0625	0.8	0.03	21.430	0.8437	53.8	67.7
25590	25519	25500	45.618	1.7960	3.5	0.14	82.550	3.2500	2.0	0.08	23.812	0.9375	74.8	95.7
25590	25520	25500	45.618	1.7960	3.5	0.14	82.931	3.2650	0.8	0.03	23.812	0.9375	74.8	95.7
25590	25521	25500	45.618	1.7960	3.5	0.14	83.058	3.2700	3.3	0.13	23.812	0.9375	74.8	95.7
25590	25522	25500	45.618	1.7960	3.5	0.14	83.058	3.2700	2.0	0.08	23.876	0.9400	74.8	95.7
25590	25523	25500	45.618	1.7960	3.5	0.14	82.931	3.2650	2.3	0.09	26.988	1.0625	74.8	95.7
25590	25526	25500	45.618	1.7960	3.5	0.14	85.000	3.3465	2.3	0.09	23.812	0.9375	74.8	95.7
LM503349	LM503310	LM503300	45.987	1.8105	2.3	0.09	74.976	2.9518	1.5	0.06	18.000	0.7087	50.4	70
LM503349A	LM503310	LM503300	45.987	1.8105	SP	SP	74.976	2.9518	1.5	0.06	18.000	0.7087	50.4	70
359-S	352	355	46.038	1.8125	2.3	0.09	90.119	3.5480	2.3	0.09	23.000	0.9055	67.1	75.6
359A	352	355	46.038	1.8125	3.5	0.14	90.119	3.5480	2.3	0.09	23.000	0.9055	67.1	75.6
359-S	354A	355	46.038	1.8125	2.3	0.09	85.000	3.3465	1.3	0.05	20.635	0.8124	67.1	75.6
359A	354A	355	46.038	1.8125	3.5	0.14	85.000	3.3465	1.3	0.05	20.635	0.8124	67.1	75.6
359-S	354X	355	46.038	1.8125	2.3	0.09	85.000	3.3465	1.5	0.06	20.635	0.8124	67.1	75.6
359A	354X	355	46.038	1.8125	3.5	0.14	85.000	3.3465	1.5	0.06	20.635	0.8124	67.1	75.6
2984	2924	2900	46.038	1.8125	3.5	0.14	85.000	3.3465	1.3	0.05	25.400	1.0000	77	101
18690	18620	18600	46.038	1.8125	2.8	0.11	79.375	3.1250	1.5	0.06	17.462	0.6875	44.2	54.3
18780	18720	18700	46.038	1.8125	2.3	0.09	85.000	3.3465	1.5	0.06	17.462	0.6875	48.5	63

INCH AND ISO METRIC SERIES | BY CONE BORE

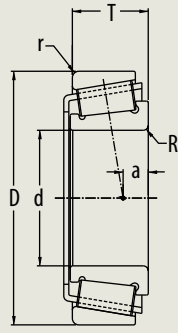

The tables include the most common industry series and sizes in the market. Additional industry series and sizes are available from PEER upon request.

Cone	Cup	Series	d		R		D		r		T		Basic Load Rating	
			Cone Bore		Max Shaft Radius		Cup Outer Diameter		Max Housing Radius		Total Width		Dynamic Cr	Static Cor
			mm	inch	mm	inch	mm	inch	mm	inch	mm	inch	KN	KN
369-S	362	365	47.625	1.8750	2.3	0.09	90.000	3.5433	2.0	0.08	20.000	0.7874	71.1	82.3
369A	362	365	47.625	1.8750	3.5	0.14	90.000	3.5433	2.0	0.08	20.000	0.7874	71.1	82.3
369-S	362A	365	47.625	1.8750	2.3	0.09	88.900	3.5000	1.3	0.05	20.637	0.8125	71.1	82.3
369A	362A	365	47.625	1.8750	3.5	0.14	88.900	3.5000	1.3	0.05	20.637	0.8125	71.1	82.3
369-S	362X	365	47.625	1.8750	2.3	0.09	90.000	3.5433	2.0	0.08	25.000	0.9843	71.1	82.3
369A	362X	365	47.625	1.8750	3.5	0.14	90.000	3.5433	2.0	0.08	25.000	0.9843	71.1	82.3
369-S	363	365	47.625	1.8750	2.3	0.09	90.000	3.5433	0.8	0.03	20.000	0.7874	71.1	82.3
369A	363	365	47.625	1.8750	3.5	0.14	90.000	3.5433	0.8	0.03	20.000	0.7874	71.1	82.3
386A	382	385	47.625	1.8750	0.8	0.03	98.425	3.8750	0.8	0.03	21.000	0.8268	77.2	95
386A	382A	385	47.625	1.8750	0.8	0.03	96.838	3.8125	0.8	0.03	21.000	0.8268	77.2	95
386A	382-S	385	47.625	1.8750	0.8	0.03	96.838	3.8125	2.3	0.09	25.400	1.0000	77.2	95
386A	383A	385	47.625	1.8750	0.8	0.03	100.000	3.9370	2.0	0.08	21.000	0.8268	77.2	95
467	453	455	47.625	1.8750	0.8	0.03	107.950	4.2500	0.8	0.03	27.795	1.0943	113	145
467	453A	455	47.625	1.8750	0.8	0.03	107.950	4.2500	0.8	0.03	27.782	1.0938	113	145
467	453X	455	47.625	1.8750	0.8	0.03	104.775	4.1250	3.3	0.13	30.162	1.1875	113	145
467	454	455	47.625	1.8750	0.8	0.03	110.000	4.3307	2.0	0.08	27.795	1.0943	113	145
528	522	525	47.625	1.8750	3.5	0.14	101.600	4.0000	3.3	0.13	34.925	1.3750	135	164
536	532A	535	47.625	1.8750	3.5	0.14	111.125	4.3750	3.3	0.13	38.100	1.5000	140	176
536	532X	535	47.625	1.8750	3.5	0.14	107.950	4.2500	3.3	0.13	36.513	1.4375	140	176
3778	3720	3700	47.625	1.8750	6.4	0.25	93.264	3.6718	3.3	0.13	30.162	1.1875	101	133
3779	3720	3700	47.625	1.8750	3.5	0.14	93.264	3.6718	3.3	0.13	30.162	1.1875	101	133
3778	3730	3700	47.625	1.8750	6.4	0.25	93.264	3.6718	0.8	0.03	30.162	1.1875	101	133
3779	3730	3700	47.625	1.8750	3.5	0.14	93.264	3.6718	0.8	0.03	30.162	1.1875	101	133
45282	45220	45200	47.625	1.8750	3.5	0.14	104.775	4.1250	3.3	0.13	30.162	1.1875	126	163
45282	45221	45200	47.625	1.8750	3.5	0.14	104.775	4.1250	0.8	0.03	30.162	1.1875	126	163
49580	49520	49500	47.625	1.8750	3.5	0.14	101.600	4.0000	3.3	0.13	31.750	1.2500	110	136
72188C	72487	72000C	47.625	1.8750	0.8	0.03	123.825	4.8750	3.3	0.13	36.512	1.4375	152	184
M804048	M804010	M804000	47.625	1.8750	0.8	0.03	88.900	3.5000	3.3	0.13	25.400	1.0000	82.8	103
M804049	M804010	M804000	47.625	1.8750	3.5	0.14	88.900	3.5000	3.3	0.13	25.400	1.0000	82.8	103
HM804846	HM804810	HM804800	47.625	1.8750	3.5	0.14	95.250	3.7500	3.3	0.13	30.162	1.1875	107	145
HM804848	HM804810	HM804800	48.412	1.9060	2.3	0.09	95.250	3.7500	3.3	0.13	30.162	1.1875	107	145
3781	3720	3700	49.212	1.9375	3.5	0.14	93.264	3.6718	3.3	0.13	30.162	1.1875	101	133
3781	3730	3700	49.212	1.9375	3.5	0.14	93.264	3.6718	0.8	0.03	30.162	1.1875	101	133
5562	5535	5500	49.212	1.9375	1.3	0.05	122.238	4.8125	3.3	0.13	43.658	1.7188	215	306

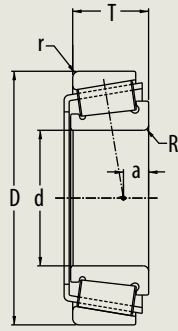

The tables include the most common industry series and sizes in the market. Additional industry series and sizes are available from PEER upon request.

Cone	Cup	Series	d		R		D		r		T		Basic Load Rating	
			Cone Bore		Max Shaft Radius		Cup Outer Diameter		Max Housing Radius		Total Width		Dynamic Cr	Static Cor
			mm	inch	mm	inch	mm	inch	mm	inch	mm	inch	KN	KN
65390	65320	65300	49.212	1.9375	3.5	0.14	114.300	4.5000	3.3	0.13	44.450	1.7500	184	222
HH506348	HH506310	HH506300	49.212	1.9375	3.5	0.14	114.300	4.5000	3.3	0.13	44.450	1.7500	205	254
HM807044	HM807010	HM807000	49.212	1.9375	3.5	0.14	104.775	4.1250	3.3	0.13	36.512	1.4375	151	210
HM807044	JHM807012	HM807000	49.212	1.9375	3.5	0.14	105.000	4.1339	2.5	0.10	36.873	1.4517	151	210
28579	28520	28500	49.987	1.9680	2.3	0.09	89.980	3.5425	2.3	0.09	24.750	0.9744	82.4	113
28579	28521	28500	49.987	1.9680	2.3	0.09	92.075	3.6250	0.8	0.03	24.607	0.9688	82.4	113
366	362	365	50.000	1.9685	2.3	0.09	90.000	3.5433	2.0	0.08	20.000	0.7874	71.1	82.3
366	362A	365	50.000	1.9685	2.3	0.09	88.900	3.5000	1.3	0.05	20.637	0.8125	71.1	82.3
366	362X	365	50.000	1.9685	2.3	0.09	90.000	3.5433	2.0	0.08	25.000	0.9843	71.1	82.3
366	363	365	50.000	1.9685	2.3	0.09	90.000	3.5433	0.8	0.03	20.000	0.7874	71.1	82.3
396	393	395	50.000	1.9685	0.8	0.03	110.000	4.3307	0.8	0.03	27.000	1.0630	82.5	108
396	393AS	395	50.000	1.9685	0.8	0.03	111.125	4.3750	1.3	0.05	22.000	0.8661	82.5	108
396	394A	395	50.000	1.9685	0.8	0.03	110.000	4.3307	1.3	0.05	22.000	0.8661	82.5	108
396	394AS	395	50.000	1.9685	0.8	0.03	110.000	4.3307	3.3	0.13	22.000	0.8661	82.5	108
396	3920	395	50.000	1.9685	0.8	0.03	112.712	4.4375	3.3	0.13	26.967	1.0617	82.5	108
JLM104948	JLM104910	LM104900	50.000	1.9685	3.0	0.12	82.000	3.2283	0.5	0.02	21.500	0.8465	66.8	88.9
JLM104948	LM104911	LM104900	50.000	1.9685	3.0	0.12	82.550	3.2500	1.3	0.05	21.116	0.8313	66.8	88.9
JM205149	JM205110	M205100	50.000	1.9685	3.0	0.12	90.000	3.5433	2.5	0.10	28.000	1.1024	101	131
JM205149A	JM205110	M205100	50.000	1.9685	5.0	0.20	90.000	3.5433	2.5	0.10	28.000	1.1024	101	131
JLM704649	JLM704610	LM704600	50.000	1.9685	3.5	0.14	84.000	3.3071	1.5	0.06	22.000	0.8661	67	90
JHM807045	HM807010	HM807000	50.000	1.9685	3.0	0.12	104.775	4.1250	3.3	0.13	36.639	1.4425	151	210
JHM807045	JHM807012	HM807000	50.000	1.9685	3.0	0.12	105.000	4.1339	2.5	0.10	37.000	1.4567	151	210
X30210	Y30210	30210	50.000	1.9685	1.5	0.06	90.000	3.5433	1.5	0.06	21.750	0.8563	73	86.4
X30310	Y30310	30310	50.000	1.9685	2.5	0.10	110.000	4.3307	2.0	0.08	29.250	1.1516	129	146
X31310	Y31310	31310	50.000	1.9685	2.5	0.10	110.000	4.3307	2.0	0.08	29.250	1.1516	105	117
X32010X	Y32010X	32010X	50.000	1.9685	1.0	0.04	80.000	3.1496	1.0	0.04	20.000	0.7874	58.3	83.7
X32210	Y32210	32210	50.000	1.9685	1.5	0.06	90.000	3.5433	1.5	0.06	24.750	0.9744	83.3	102
X32310	Y32310	32310	50.000	1.9685	2.5	0.10	110.000	4.3307	2.0	0.08	42.250	1.6634	179	225
X32310B	Y32310B	32310B	50.000	1.9685	2.5	0.10	110.000	4.3307	2.0	0.08	42.250	1.6634	165	224
X33010	Y33010	33010	50.000	1.9685	1.0	0.04	80.000	3.1496	1.0	0.04	24.000	0.9449	73.9	106
X33110	Y33110	33110	50.000	1.9685	1.5	0.06	85.000	3.3465	1.5	0.06	26.000	1.0236	85.4	117
X33210	Y33210	33210	50.000	1.9685	1.5	0.06	90.000	3.5433	1.5	0.06	32.000	1.2598	110	149
368	362	365	50.800	2.0000	1.5	0.06	90.000	3.5433	2.0	0.08	20.000	0.7874	71.1	82.3
368A	362	365	50.800	2.0000	3.5	0.14	90.000	3.5433	2.0	0.08	20.000	0.7874	71.1	82.3

INCH AND ISO METRIC SERIES | BY CONE BORE

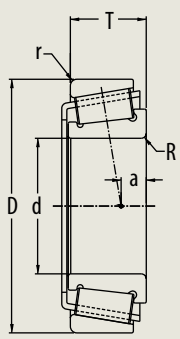

The tables include the most common industry series and sizes in the market. Additional industry series and sizes are available from PEER upon request.

Cone	Cup	Series	d		R		D		r		T		Basic Load Rating	
			Cone Bore		Max Shaft Radius		Cup Outer Diameter		Max Housing Radius		Total Width		Dynamic Cr	Static Cor
			mm	inch	mm	inch	mm	inch	mm	inch	mm	inch	KN	KN
370A	362	365	50.800	2.0000	5.0	0.20	90.000	3.5433	2.0	0.08	20.000	0.7874	71.1	82.3
368	362A	365	50.800	2.0000	1.5	0.06	88.900	3.5000	1.3	0.05	20.637	0.8125	71.1	82.3
368A	362A	365	50.800	2.0000	3.5	0.14	88.900	3.5000	1.3	0.05	20.637	0.8125	71.1	82.3
370A	362A	365	50.800	2.0000	5.0	0.20	88.900	3.5000	1.3	0.05	20.637	0.8125	71.1	82.3
368	362X	365	50.800	2.0000	1.5	0.06	90.000	3.5433	2.0	0.08	25.000	0.9843	71.1	82.3
368A	362X	365	50.800	2.0000	3.5	0.14	90.000	3.5433	2.0	0.08	25.000	0.9843	71.1	82.3
370A	362X	365	50.800	2.0000	5.0	0.20	90.000	3.5433	2.0	0.08	25.000	0.9843	71.1	82.3
368	363	365	50.800	2.0000	1.5	0.06	90.000	3.5433	0.8	0.03	20.000	0.7874	71.1	82.3
368A	363	365	50.800	2.0000	3.5	0.14	90.000	3.5433	0.8	0.03	20.000	0.7874	71.1	82.3
370A	363	365	50.800	2.0000	5.0	0.20	90.000	3.5433	0.8	0.03	20.000	0.7874	71.1	82.3
385A	382	385	50.800	2.0000	2.3	0.09	98.425	3.8750	0.8	0.03	21.000	0.8268	77.2	95
385A	382A	385	50.800	2.0000	2.3	0.09	96.838	3.8125	0.8	0.03	21.000	0.8268	77.2	95
385A	382-S	385	50.800	2.0000	2.3	0.09	96.838	3.8125	2.3	0.09	25.400	1.0000	77.2	95
385A	383A	385	50.800	2.0000	2.3	0.09	100.000	3.9370	2.0	0.08	21.000	0.8268	77.2	95
455	453	455	50.800	2.0000	0.8	0.03	107.950	4.2500	0.8	0.03	27.795	1.0943	113	145
455	453A	455	50.800	2.0000	0.8	0.03	107.950	4.2500	0.8	0.03	27.782	1.0938	113	145
455	453X	455	50.800	2.0000	0.8	0.03	104.775	4.1250	3.3	0.13	30.162	1.1875	113	145
455	454	455	50.800	2.0000	0.8	0.03	110.000	4.3307	2.0	0.08	27.795	1.0943	113	145
529	522	525	50.800	2.0000	0.8	0.03	101.600	4.0000	3.3	0.13	34.925	1.3750	135	164
529X	522	525	50.800	2.0000	3.5	0.14	101.600	4.0000	3.3	0.13	34.925	1.3750	135	164
537	532A	535	50.800	2.0000	3.5	0.14	111.125	4.3750	3.3	0.13	38.100	1.5000	140	176
537	532X	535	50.800	2.0000	3.5	0.14	107.950	4.2500	3.3	0.13	36.513	1.4375	140	176
555	552	555	50.800	2.0000	2.3	0.09	123.825	4.8750	3.3	0.13	38.100	1.5000	157	215
555	552A	555	50.800	2.0000	2.3	0.09	123.825	4.8750	3.3	0.13	38.100	1.5000	157	215
3775	3720	3700	50.800	2.0000	0.8	0.03	93.264	3.6718	3.3	0.13	30.162	1.1875	101	133
3780	3720	3700	50.800	2.0000	3.5	0.14	93.264	3.6718	3.3	0.13	30.162	1.1875	101	133
3784	3720	3700	50.800	2.0000	6.4	0.25	93.264	3.6718	3.3	0.13	30.162	1.1875	101	133
3775	3730	3700	50.800	2.0000	0.8	0.03	93.264	3.6718	0.8	0.03	30.162	1.1875	101	133
3780	3730	3700	50.800	2.0000	3.5	0.14	93.264	3.6718	0.8	0.03	30.162	1.1875	101	133
3784	3730	3700	50.800	2.0000	6.4	0.25	93.264	3.6718	0.8	0.03	30.162	1.1875	101	133
5565	5535	5500	50.800	2.0000	1.3	0.05	122.238	4.8125	3.3	0.13	43.658	1.7188	215	306
18790	18720	18700	50.800	2.0000	3.5	0.14	85.000	3.3465	1.5	0.06	17.462	0.6875	48.5	63
28580	28520	28500	50.800	2.0000	3.5	0.14	89.980	3.5425	2.3	0.09	24.750	0.9744	82.4	113
28580	28521	28500	50.800	2.0000	3.5	0.14	92.075	3.6250	0.8	0.03	24.607	0.9688	82.4	113

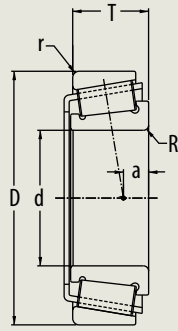

The tables include the most common industry series and sizes in the market. Additional industry series and sizes are available from PEER upon request.

Cone	Cup	Series	d		R		D		r		T		Basic Load Rating	
			Cone Bore		Max Shaft Radius		Cup Outer Diameter		Max Housing Radius		Total Width		Dynamic Cr	Static Cor
			mm	inch	mm	inch	mm	inch	mm	inch	mm	inch	KN	KN
28678	28621	28600	50.800	2.0000	3.5	0.14	96.838	3.8125	0.8	0.03	24.608	0.9688	86.8	125
28678	28622	28600	50.800	2.0000	3.5	0.14	97.630	3.8437	0.8	0.03	24.608	0.9688	86.8	125
33889	33821	33800	50.800	2.0000	3.5	0.14	95.250	3.7500	2.3	0.09	27.783	1.0938	106	138
33889	33822	33800	50.800	2.0000	3.5	0.14	95.250	3.7500	0.8	0.03	27.783	1.0938	106	138
45284	45220	45200	50.800	2.0000	6.4	0.25	104.775	4.1250	3.3	0.13	30.162	1.1875	126	163
45284	45221	45200	50.800	2.0000	6.4	0.25	104.775	4.1250	0.8	0.03	30.162	1.1875	126	163
55200C	55437	55000C	50.800	2.0000	3.5	0.14	111.125	4.3750	3.3	0.13	30.162	1.1875	111	150
55200C	55443	55000C	50.800	2.0000	3.5	0.14	112.712	4.4375	3.3	0.13	30.162	1.1875	111	150
59200	59412	59000	50.800	2.0000	3.5	0.14	104.775	4.1250	3.3	0.13	36.512	1.4375	139	191
72200C	72487	72000C	50.800	2.0000	3.5	0.14	123.825	4.8750	3.3	0.13	36.512	1.4375	152	184
72201C	72487	72000C	50.800	2.0000	0.8	0.03	123.825	4.8750	3.3	0.13	36.512	1.4375	152	184
LM104949	JLM104910	LM104900	50.800	2.0000	3.5	0.14	82.000	3.2283	0.5	0.02	21.500	0.8465	66.8	88.9
LM104949	LM104911	LM104900	50.800	2.0000	3.5	0.14	82.550	3.2500	1.3	0.05	21.116	0.8313	66.8	88.9
L305649	L305610	L305600	50.800	2.0000	1.5	0.06	80.962	3.1875	1.5	0.06	18.257	0.7188	51.7	76.4
HM807046	HM807010	HM807000	50.800	2.0000	3.5	0.14	104.775	4.1250	3.3	0.13	36.512	1.4375	151	210
HM807046	JHM807012	HM807000	50.800	2.0000	3.5	0.14	105.000	4.1339	2.5	0.10	36.873	1.4517	151	210
368-S	362	365	51.592	2.0312	2.0	0.08	90.000	3.5433	2.0	0.08	20.000	0.7874	71.1	82.3
368-S	362A	365	51.592	2.0312	2.0	0.08	88.900	3.5000	1.3	0.05	20.637	0.8125	71.1	82.3
368-S	362X	365	51.592	2.0312	2.0	0.08	90.000	3.5433	2.0	0.08	25.000	0.9843	71.1	82.3
368-S	363	365	51.592	2.0312	2.0	0.08	90.000	3.5433	0.8	0.03	20.000	0.7874	71.1	82.3
3767	3720	3700	52.388	2.0625	2.3	0.09	93.264	3.6718	3.3	0.13	30.162	1.1875	101	133
3767	3730	3700	52.388	2.0625	2.3	0.09	93.264	3.6718	0.8	0.03	30.162	1.1875	101	133
28584	28520	28500	52.388	2.0625	3.5	0.14	89.980	3.5425	2.3	0.09	24.750	0.9744	82.4	113
28584	28521	28500	52.388	2.0625	3.5	0.14	92.075	3.6250	0.8	0.03	24.607	0.9688	82.4	113
33891	33821	33800	52.388	2.0625	3.5	0.14	95.250	3.7500	2.3	0.09	27.783	1.0938	106	138
33891	33822	33800	52.388	2.0625	3.5	0.14	95.250	3.7500	0.8	0.03	27.783	1.0938	106	138
539	532A	535	53.975	2.1250	3.5	0.14	111.125	4.3750	3.3	0.13	38.100	1.5000	140	176
539A	532A	535	53.975	2.1250	5.5	0.22	111.125	4.3750	3.3	0.13	38.100	1.5000	140	176
539	532X	535	53.975	2.1250	3.5	0.14	107.950	4.2500	3.3	0.13	36.513	1.4375	140	176
539A	532X	535	53.975	2.1250	5.5	0.22	107.950	4.2500	3.3	0.13	36.513	1.4375	140	176
557-S	552	555	53.975	2.1250	3.5	0.14	123.825	4.8750	3.3	0.13	38.100	1.5000	157	215
557-S	552A	555	53.975	2.1250	3.5	0.14	123.825	4.8750	3.3	0.13	38.100	1.5000	157	215
621	612	615	53.975	2.1250	3.5	0.14	120.650	4.7500	3.3	0.13	41.275	1.6250	170	210
5578	5535	5500	53.975	2.1250	3.5	0.14	122.238	4.8125	3.3	0.13	43.658	1.7188	215	306

INCH AND ISO METRIC SERIES | BY CONE BORE

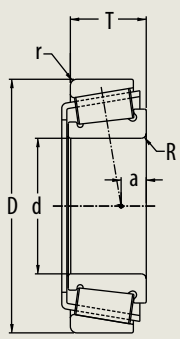

The tables include the most common industry series and sizes in the market. Additional industry series and sizes are available from PEER upon request.

Cone	Cup	Series	d		R		D		r		T		Basic Load Rating	
			Cone Bore		Max Shaft Radius		Cup Outer Diameter		Max Housing Radius		Total Width		Dynamic Cr	Static Cor
			mm	inch	mm	inch	mm	inch	mm	inch	mm	inch	KN	KN
72213C	72487	72000C	53.975	2.1250	3.5	0.14	123.825	4.8750	3.3	0.13	36.512	1.4375	152	184
LM806649	LM806610	LM806600	53.975	2.1250	2.3	0.09	88.900	3.5000	2.0	0.08	19.050	0.7500	58.3	78.1
HM807049	HM807010	HM807000	53.975	2.1250	3.5	0.14	104.775	4.1250	3.3	0.13	36.512	1.4375	151	210
HM807049	JHM807012	HM807000	53.975	2.1250	3.5	0.14	105.000	4.1339	2.5	0.10	36.873	1.4517	151	210
6381	6320	6300	54.988	2.1649	3.5	0.14	135.755	5.3447	3.3	0.13	53.975	2.1250	263	351
385	382	385	55.000	2.1654	2.3	0.09	98.425	3.8750	0.8	0.03	21.000	0.8268	77.2	95
385X	382	385	55.000	2.1654	3.5	0.14	98.425	3.8750	0.8	0.03	21.000	0.8268	77.2	95
385	382A	385	55.000	2.1654	2.3	0.09	96.838	3.8125	0.8	0.03	21.000	0.8268	77.2	95
385X	382A	385	55.000	2.1654	3.5	0.14	96.838	3.8125	0.8	0.03	21.000	0.8268	77.2	95
385	382-S	385	55.000	2.1654	2.3	0.09	96.838	3.8125	2.3	0.09	25.400	1.0000	77.2	95
385X	382-S	385	55.000	2.1654	3.5	0.14	96.838	3.8125	2.3	0.09	25.400	1.0000	77.2	95
385	383A	385	55.000	2.1654	2.3	0.09	100.000	3.9370	2.0	0.08	21.000	0.8268	77.2	95
385X	383A	385	55.000	2.1654	3.5	0.14	100.000	3.9370	2.0	0.08	21.000	0.8268	77.2	95
JM207049	JM207010	M207000	55.000	2.1654	1.5	0.06	95.000	3.7402	2.5	0.10	29.000	1.1417	108	146
JM207049A	JM207010	M207000	55.000	2.1654	6.0	0.24	95.000	3.7402	2.5	0.10	29.000	1.1417	108	146
JM207049	JM207010A	M207000	55.000	2.1654	1.5	0.06	95.000	3.7402	2.0	0.08	30.000	1.1811	108	146
JM207049A	JM207010A	M207000	55.000	2.1654	6.0	0.24	95.000	3.7402	2.0	0.08	30.000	1.1811	108	146
JH307749	JH307710	H307700	55.000	2.1654	3.0	0.12	110.000	4.3307	2.5	0.10	39.000	1.5354	172	218
JLM506849	JLM506810	LM506800	55.000	2.1654	1.5	0.06	90.000	3.5433	0.5	0.02	23.000	0.9055	77.9	108
X30211	Y30211	30211	55.000	2.1654	2.0	0.08	100.000	3.9370	1.5	0.06	22.750	0.8957	88.7	104
X30311	Y30311	30311	55.000	2.1654	2.5	0.10	120.000	4.7244	2.0	0.08	31.500	1.2402	153	176
X31311	Y31311	31311	55.000	2.1654	2.5	0.10	120.000	4.7244	2.0	0.08	31.500	1.2402	128	146
X32011X	Y32011X	32011X	55.000	2.1654	1.5	0.06	90.000	3.5433	1.5	0.06	23.000	0.9055	75.9	109
X32211	Y32211	32211	55.000	2.1654	2.0	0.08	100.000	3.9370	1.5	0.06	26.750	1.0531	108	133
X32311	Y32311	32311	55.000	2.1654	2.5	0.10	120.000	4.7244	2.0	0.08	45.500	1.7913	206	260
X32311B	Y32311B	32311B	55.000	2.1654	2.5	0.10	120.000	4.7244	2.0	0.08	45.500	1.7913	188	250
X33011	Y33011	33011	55.000	2.1654	1.5	0.06	90.000	3.5433	1.5	0.06	27.000	1.0630	90.8	137
X33111	Y33111	33111	55.000	2.1654	1.5	0.06	95.000	3.7402	1.5	0.06	30.000	1.1811	111	158
X33211	Y33211	33211	55.000	2.1654	2.0	0.08	100.000	3.9370	1.5	0.06	35.000	1.3780	137	186
5566	5535	5500	55.562	2.1875	1.3	0.05	122.238	4.8125	3.3	0.13	43.658	1.7188	215	306
HM813840	HM813810	HM813800	55.562	2.1875	3.5	0.14	127.000	5.0000	3.3	0.13	36.512	1.4375	161	225
389	382	385	55.575	2.1880	2.3	0.09	98.425	3.8750	0.8	0.03	21.000	0.8268	77.2	95
389	382A	385	55.575	2.1880	2.3	0.09	96.838	3.8125	0.8	0.03	21.000	0.8268	77.2	95
389	382-S	385	55.575	2.1880	2.3	0.09	96.838	3.8125	2.3	0.09	25.400	1.0000	77.2	95

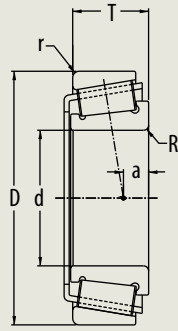

The tables include the most common industry series and sizes in the market. Additional industry series and sizes are available from PEER upon request.

Cone	Cup	Series	d		R		D		r		T		Basic Load Rating	
			Cone Bore		Max Shaft Radius		Cup Outer Diameter		Max Housing Radius		Total Width		Dynamic Cr	Static Cor
			mm	inch	mm	inch	mm	inch	mm	inch	mm	inch	KN	KN
389	383A	385	55.575	2.1880	2.3	0.09	100.000	3.9370	2.0	0.08	21.000	0.8268	77.2	95
387	382	385	57.150	2.2500	2.3	0.09	98.425	3.8750	0.8	0.03	21.000	0.8268	77.2	95
387-S	382	385	57.150	2.2500	0.8	0.03	98.425	3.8750	0.8	0.03	21.000	0.8268	77.2	95
387A	382	385	57.150	2.2500	3.5	0.14	98.425	3.8750	0.8	0.03	21.000	0.8268	77.2	95
387AS	382	385	57.150	2.2500	5.2	0.20	98.425	3.8750	0.8	0.03	21.000	0.8268	77.2	95
387	382A	385	57.150	2.2500	2.3	0.09	96.838	3.8125	0.8	0.03	21.000	0.8268	77.2	95
387-S	382A	385	57.150	2.2500	0.8	0.03	96.838	3.8125	0.8	0.03	21.000	0.8268	77.2	95
387A	382A	385	57.150	2.2500	3.5	0.14	96.838	3.8125	0.8	0.03	21.000	0.8268	77.2	95
387AS	382A	385	57.150	2.2500	5.2	0.20	96.838	3.8125	0.8	0.03	21.000	0.8268	77.2	95
387	382-S	385	57.150	2.2500	2.3	0.09	96.838	3.8125	2.3	0.09	25.400	1.0000	77.2	95
387-S	382-S	385	57.150	2.2500	0.8	0.03	96.838	3.8125	2.3	0.09	25.400	1.0000	77.2	95
387A	382-S	385	57.150	2.2500	3.5	0.14	96.838	3.8125	2.3	0.09	25.400	1.0000	77.2	95
387AS	382-S	385	57.150	2.2500	5.2	0.20	96.838	3.8125	2.3	0.09	25.400	1.0000	77.2	95
387	383A	385	57.150	2.2500	2.3	0.09	100.000	3.9370	2.0	0.08	21.000	0.8268	77.2	95
387-S	383A	385	57.150	2.2500	0.8	0.03	100.000	3.9370	2.0	0.08	21.000	0.8268	77.2	95
387A	383A	385	57.150	2.2500	3.5	0.14	100.000	3.9370	2.0	0.08	21.000	0.8268	77.2	95
387AS	383A	385	57.150	2.2500	5.2	0.20	100.000	3.9370	2.0	0.08	21.000	0.8268	77.2	95
390	393	395	57.150	2.2500	2.3	0.09	110.000	4.3307	0.8	0.03	27.000	1.0630	82.5	108
390	393AS	395	57.150	2.2500	2.3	0.09	111.125	4.3750	1.3	0.05	22.000	0.8661	82.5	108
390	394A	395	57.150	2.2500	2.3	0.09	110.000	4.3307	1.3	0.05	22.000	0.8661	82.5	108
390	394AS	395	57.150	2.2500	2.3	0.09	110.000	4.3307	3.3	0.13	22.000	0.8661	82.5	108
390	3920	395	57.150	2.2500	2.3	0.09	112.712	4.4375	3.3	0.13	26.967	1.0617	82.5	108
462	453	455	57.150	2.2500	2.3	0.09	107.950	4.2500	0.8	0.03	27.795	1.0943	113	145
469	453	455	57.150	2.2500	3.5	0.14	107.950	4.2500	0.8	0.03	27.795	1.0943	113	145
462	453A	455	57.150	2.2500	2.3	0.09	107.950	4.2500	0.8	0.03	27.782	1.0938	113	145
469	453A	455	57.150	2.2500	3.5	0.14	107.950	4.2500	0.8	0.03	27.782	1.0938	113	145
462	453X	455	57.150	2.2500	2.3	0.09	104.775	4.1250	3.3	0.13	30.162	1.1875	113	145
469	453X	455	57.150	2.2500	3.5	0.14	104.775	4.1250	3.3	0.13	30.162	1.1875	113	145
462	454	455	57.150	2.2500	2.3	0.09	110.000	4.3307	2.0	0.08	27.795	1.0943	113	145
469	454	455	57.150	2.2500	3.5	0.14	110.000	4.3307	2.0	0.08	27.795	1.0943	113	145
555-S	552	555	57.150	2.2500	3.5	0.14	123.825	4.8750	3.3	0.13	38.100	1.5000	157	215
555-S	552A	555	57.150	2.2500	3.5	0.14	123.825	4.8750	3.3	0.13	38.100	1.5000	157	215
623	612	615	57.150	2.2500	3.5	0.14	120.650	4.7500	3.3	0.13	41.275	1.6250	170	210
635	632	635	57.150	2.2500	3.5	0.14	136.525	5.3750	3.3	0.13	41.275	1.6250	192	258

INCH AND ISO METRIC SERIES | BY CONE BORE

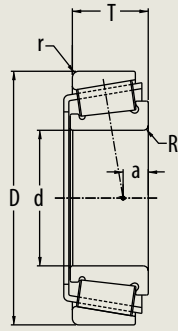

The tables include the most common industry series and sizes in the market. Additional industry series and sizes are available from PEER upon request.

Cone	Cup	Series	d		R		D		r		T		Basic Load Rating	
			Cone Bore		Max Shaft Radius		Cup Outer Diameter		Max Housing Radius		Total Width		Dynamic Cr	Static Cor
			mm	inch	mm	inch	mm	inch	mm	inch	mm	inch	KN	KN
635	633	635	57.150	2.2500	3.5	0.14	130.175	5.1250	3.3	0.13	41.275	1.6250	192	258
3979	3920	3900	57.150	2.2500	3.5	0.14	112.712	4.4375	3.3	0.13	30.162	1.1875	115	166
3979	3925	3900	57.150	2.2500	3.5	0.14	112.712	4.4375	0.8	0.03	30.162	1.1875	115	166
3979	3926	3900	57.150	2.2500	3.5	0.14	112.712	4.4375	3.3	0.13	33.338	1.3125	115	166
6455	6420	6400	57.150	2.2500	3.5	0.14	149.225	5.8750	3.3	0.13	53.975	2.1250	284	403
28682	28621	28600	57.150	2.2500	3.5	0.14	96.838	3.8125	0.8	0.03	24.608	0.9688	86.8	125
28682	28622	28600	57.150	2.2500	3.5	0.14	97.630	3.8437	0.8	0.03	24.608	0.9688	86.8	125
33225	33462	33000	57.150	2.2500	3.5	0.14	117.475	4.6250	3.3	0.13	30.162	1.1875	115	172
33225	33472	33000	57.150	2.2500	3.5	0.14	120.000	4.7244	0.8	0.03	29.794	1.1730	115	172
39581	39520	39500	57.150	2.2500	8.0	0.31	112.712	4.4375	3.3	0.13	30.162	1.1875	138	193
72225C	72487	72000C	57.150	2.2500	3.5	0.14	123.825	4.8750	3.3	0.13	36.512	1.4375	152	184
78225	78537	78000	57.150	2.2500	3.5	0.14	136.525	5.3750	3.3	0.13	36.512	1.4375	148	174
78225	78551	78000	57.150	2.2500	3.5	0.14	140.030	5.5130	2.3	0.09	36.512	1.4375	148	174
78225C	78551	78000C	57.150	2.2500	3.5	0.14	140.030	5.5130	2.3	0.09	36.512	1.4375	147	172
388A	382	385	57.531	2.2650	3.5	0.14	98.425	3.8750	0.8	0.03	21.000	0.8268	77.2	95
388A	382A	385	57.531	2.2650	3.5	0.14	96.838	3.8125	0.8	0.03	21.000	0.8268	77.2	95
388A	382-S	385	57.531	2.2650	3.5	0.14	96.838	3.8125	2.3	0.09	25.400	1.0000	77.2	95
388A	383A	385	57.531	2.2650	3.5	0.14	100.000	3.9370	2.0	0.08	21.000	0.8268	77.2	95
28980	28920	28900	59.977	2.3613	3.5	0.14	101.600	4.0000	3.3	0.13	25.400	1.0000	88.8	130
28980	28921	28900	59.977	2.3613	3.5	0.14	100.000	3.9370	3.3	0.13	25.400	1.0000	88.8	130
JLM508748	JLM508710	LM508700	60.000	2.3622	5.0	0.20	95.000	3.7402	2.5	0.10	24.000	0.9449	82.5	118
X30212	Y30212	30212	60.000	2.3622	2.0	0.08	110.000	4.3307	1.5	0.06	23.750	0.9350	99.5	117
X30312	Y30312	30312	60.000	2.3622	3.0	0.12	130.000	5.1181	2.5	0.10	33.500	1.3189	174	202
X31312	Y31312	31312	60.000	2.3622	3.0	0.12	130.000	5.1181	2.5	0.10	33.500	1.3189	148	170
X32012X	Y32012X	32012X	60.000	2.3622	1.5	0.06	95.000	3.7402	1.5	0.06	23.000	0.9055	77.5	114
X32212	Y32212	32212	60.000	2.3622	2.0	0.08	110.000	4.3307	1.5	0.06	29.750	1.1713	133	169
X32312	Y32312	32312	60.000	2.3622	3.0	0.12	130.000	5.1181	2.5	0.10	48.500	1.9094	233	295
X32312B	Y32312B	32312B	60.000	2.3622	3.0	0.12	130.000	5.1181	2.5	0.10	48.500	1.9094	219	294
X33012	Y33012	33012	60.000	2.3622	1.5	0.06	95.000	3.7402	1.5	0.06	27.000	1.0630	92.8	143
X33112	Y33112	33112	60.000	2.3622	1.5	0.06	100.000	3.9370	1.5	0.06	30.000	1.1811	114	167
X33212	Y33212	33212	60.000	2.3622	2.0	0.08	110.000	4.3307	1.5	0.06	38.000	1.4961	160	221
557A	552	555	60.325	2.3750	8.0	0.31	123.825	4.8750	3.3	0.13	38.100	1.5000	157	215
557A	552A	555	60.325	2.3750	8.0	0.31	123.825	4.8750	3.3	0.13	38.100	1.5000	157	215
3980	3920	3900	60.325	2.3750	3.5	0.14	112.712	4.4375	3.3	0.13	30.162	1.1875	115	166

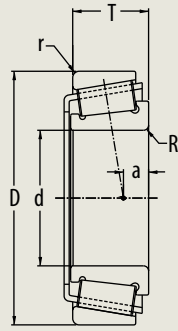

The tables include the most common industry series and sizes in the market. Additional industry series and sizes are available from PEER upon request.

Cone	Cup	Series	d		R		D		r		T		Basic Load Rating	
			Cone Bore		Max Shaft Radius		Cup Outer Diameter		Max Housing Radius		Total Width		Dynamic Cr	Static Cor
			mm	inch	mm	inch	mm	inch	mm	inch	mm	inch	KN	KN
3980	3925	3900	60.325	2.3750	3.5	0.14	112.712	4.4375	0.8	0.03	30.162	1.1875	115	166
3980	3926	3900	60.325	2.3750	3.5	0.14	112.712	4.4375	3.3	0.13	33.338	1.3125	115	166
5582	5535	5500	60.325	2.3750	0.8	0.03	122.238	4.8125	3.3	0.13	43.658	1.7188	215	306
5583	5535	5500	60.325	2.3750	3.5	0.14	122.238	4.8125	3.3	0.13	43.658	1.7188	215	306
6376	6320	6300	60.325	2.3750	3.5	0.14	135.755	5.3447	3.3	0.13	53.975	2.1250	263	351
28985	28920	28900	60.325	2.3750	3.5	0.14	101.600	4.0000	3.3	0.13	25.400	1.0000	88.8	130
28985	28921	28900	60.325	2.3750	3.5	0.14	100.000	3.9370	3.3	0.13	25.400	1.0000	88.8	130
65237	65500	65000	60.325	2.3750	3.5	0.14	127.000	5.0000	3.3	0.13	44.450	1.7500	202	261
HM212044	HM212010	HM212000	60.325	2.3750	8.0	0.31	122.238	4.8125	1.5	0.06	38.100	1.5000	186	243
HM212044	HM212011	HM212000	60.325	2.3750	8.0	0.31	122.238	4.8125	3.3	0.13	38.100	1.5000	186	243
HM813841	HM813810	HM813800	60.325	2.3750	3.5	0.14	127.000	5.0000	3.3	0.13	36.512	1.4375	161	225
H715334	H715311	H715300	61.912	2.4375	3.5	0.14	136.525	5.3750	3.3	0.13	46.038	1.8125	226	356
H715334	H715313W	H715300	61.912	2.4375	3.5	0.14	136.525	5.3750	3.3	0.13	49.213	1.9375	226	356
28995	28920	28900	62.738	2.4700	3.5	0.14	101.600	4.0000	3.3	0.13	25.400	1.0000	88.8	130
28995	28921	28900	62.738	2.4700	3.5	0.14	100.000	3.9370	3.3	0.13	25.400	1.0000	88.8	130
395	393	395	63.500	2.5000	3.5	0.14	110.000	4.3307	0.8	0.03	27.000	1.0630	82.5	108
395	393AS	395	63.500	2.5000	3.5	0.14	111.125	4.3750	1.3	0.05	22.000	0.8661	82.5	108
395	394A	395	63.500	2.5000	3.5	0.14	110.000	4.3307	1.3	0.05	22.000	0.8661	82.5	108
395	394AS	395	63.500	2.5000	3.5	0.14	110.000	4.3307	3.3	0.13	22.000	0.8661	82.5	108
395	3920	395	63.500	2.5000	3.5	0.14	112.712	4.4375	3.3	0.13	26.967	1.0617	82.5	108
483	472	475	63.500	2.5000	3.5	0.14	120.000	4.7244	2.0	0.08	29.794	1.1730	118	161
483	472A	475	63.500	2.5000	3.5	0.14	120.000	4.7244	3.3	0.13	29.002	1.1418	118	161
483	472X	475	63.500	2.5000	3.5	0.14	123.825	4.8750	3.3	0.13	30.162	1.1875	118	161
559	552	555	63.500	2.5000	3.5	0.14	123.825	4.8750	3.3	0.13	38.100	1.5000	157	215
559	552A	555	63.500	2.5000	3.5	0.14	123.825	4.8750	3.3	0.13	38.100	1.5000	157	215
639	632	635	63.500	2.5000	3.5	0.14	136.525	5.3750	3.3	0.13	41.275	1.6250	192	258
639	633	635	63.500	2.5000	3.5	0.14	130.175	5.1250	3.3	0.13	41.275	1.6250	192	258
3982	3920	3900	63.500	2.5000	3.5	0.14	112.712	4.4375	3.3	0.13	30.162	1.1875	115	166
3982	3925	3900	63.500	2.5000	3.5	0.14	112.712	4.4375	0.8	0.03	30.162	1.1875	115	166
3982	3926	3900	63.500	2.5000	3.5	0.14	112.712	4.4375	3.3	0.13	33.338	1.3125	115	166
5584	5535	5500	63.500	2.5000	3.5	0.14	122.238	4.8125	3.3	0.13	43.658	1.7188	215	306
6382	6320	6300	63.500	2.5000	4.3	0.17	135.755	5.3447	3.3	0.13	53.975	2.1250	263	351
29585	29520	29500	63.500	2.5000	3.5	0.14	107.950	4.2500	3.3	0.13	25.400	1.0000	90	136
29585	29522	29500	63.500	2.5000	3.5	0.14	107.950	4.2500	0.8	0.03	25.400	1.0000	90	136

INCH AND ISO METRIC SERIES | BY CONE BORE

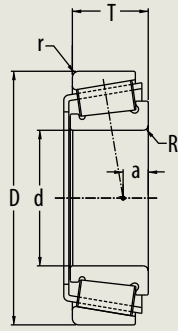

The tables include the most common industry series and sizes in the market. Additional industry series and sizes are available from PEER upon request.

Cone	Cup	Series	d		R		D		r		T		Basic Load Rating	
			Cone Bore		Max Shaft Radius		Cup Outer Diameter		Max Housing Radius		Total Width		Dynamic Cr	Static Cor
			mm	inch	mm	inch	mm	inch	mm	inch	mm	inch	KN	KN
29585	29521	29500	63.500	2.5000	3.5	0.14	110.000	4.3307	1.3	0.05	25.400	1.0000	90	136
39250	39412	39000	63.500	2.5000	2.0	0.08	104.775	4.1250	2.0	0.08	21.433	0.8438	87.8	111
39585	39520	39500	63.500	2.5000	3.5	0.14	112.712	4.4375	3.3	0.13	30.162	1.1875	138	193
HM212046	HM212010	HM212000	63.500	2.5000	3.5	0.14	122.238	4.8125	1.5	0.06	38.100	1.5000	186	243
HM212047	HM212010	HM212000	63.500	2.5000	7.0	0.28	122.238	4.8125	1.5	0.06	38.100	1.5000	186	243
HM212046	HM212011	HM212000	63.500	2.5000	3.5	0.14	122.238	4.8125	3.3	0.13	38.100	1.5000	186	243
HM212047	HM212011	HM212000	63.500	2.5000	7.0	0.28	122.238	4.8125	3.3	0.13	38.100	1.5000	186	243
396-S	393	395	64.973	2.5580	3.5	0.14	110.000	4.3307	0.8	0.03	27.000	1.0630	82.5	108
396-S	393AS	395	64.973	2.5580	3.5	0.14	111.125	4.3750	1.3	0.05	22.000	0.8661	82.5	108
396-S	394A	395	64.973	2.5580	3.5	0.14	110.000	4.3307	1.3	0.05	22.000	0.8661	82.5	108
396-S	394AS	395	64.973	2.5580	3.5	0.14	110.000	4.3307	3.3	0.13	22.000	0.8661	82.5	108
396-S	3920	395	64.973	2.5580	3.5	0.14	112.712	4.4375	3.3	0.13	26.967	1.0617	82.5	108
JH211749	JH211710	H211700	65.000	2.5591	3.0	0.12	120.000	4.7244	2.5	0.10	39.000	1.5354	185	248
JM511945	JM511910	M511900	65.000	2.5591	3.0	0.12	110.000	4.3307	2.5	0.10	28.000	1.1024	115	165
JM511946	JM511910	M511900	65.000	2.5591	3.0	0.12	110.000	4.3307	2.5	0.10	28.000	1.1024	115	165
JLM710949	JLM710910	LM710900	65.000	2.5591	3.0	0.12	105.000	4.1339	1.0	0.04	24.000	0.9449	90.7	122
X30213	Y30213	30213	65.000	2.5591	2.0	0.08	120.000	4.7244	1.5	0.06	24.750	0.9744	118	140
X30313	Y30313	30313	65.000	2.5591	3.0	0.12	140.000	5.5118	2.5	0.10	36.000	1.4173	199	233
X31313	Y31313	31313	65.000	2.5591	3.0	0.12	140.000	5.5118	2.5	0.10	36.000	1.4173	168	195
X32013X	Y32013X	32013X	65.000	2.5591	1.5	0.06	100.000	3.9370	1.5	0.06	23.000	0.9055	78.4	119
X32213	Y32213	32213	65.000	2.5591	2.0	0.08	120.000	4.7244	1.5	0.06	32.750	1.2894	161	209
X32313	Y32313	32313	65.000	2.5591	3.0	0.12	140.000	5.5118	2.5	0.10	51.000	2.0079	267	341
X33013	Y33013	33013	65.000	2.5591	1.5	0.06	100.000	3.9370	1.5	0.06	27.000	1.0630	94.5	150
X33113	Y33113	33113	65.000	2.5591	1.5	0.06	110.000	4.3307	1.5	0.06	34.000	1.3386	138	211
X33213	Y33213	33213	65.000	2.5591	2.0	0.08	120.000	4.7244	1.5	0.06	41.000	1.6142	195	269
6379	6320	6300	65.088	2.5625	3.5	0.14	135.755	5.3447	3.3	0.13	53.975	2.1250	263	351
5595	5535	5500	65.883	2.5938	3.5	0.14	122.238	4.8125	3.3	0.13	43.658	1.7188	215	306
395A	393	395	66.675	2.6250	0.8	0.03	110.000	4.3307	0.8	0.03	27.000	1.0630	82.5	108
395A	393AS	395	66.675	2.6250	0.8	0.03	111.125	4.3750	1.3	0.05	22.000	0.8661	82.5	108
395A	394A	395	66.675	2.6250	0.8	0.03	110.000	4.3307	1.3	0.05	22.000	0.8661	82.5	108
395A	394AS	395	66.675	2.6250	0.8	0.03	110.000	4.3307	3.3	0.13	22.000	0.8661	82.5	108
395A	3920	395	66.675	2.6250	0.8	0.03	112.712	4.4375	3.3	0.13	26.967	1.0617	82.5	108
560	552	555	66.675	2.6250	3.5	0.14	123.825	4.8750	3.3	0.13	38.100	1.5000	157	215
560	552A	555	66.675	2.6250	3.5	0.14	123.825	4.8750	3.3	0.13	38.100	1.5000	157	215

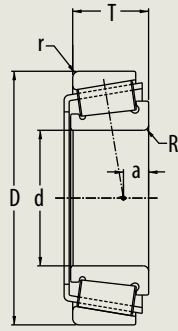

The tables include the most common industry series and sizes in the market. Additional industry series and sizes are available from PEER upon request.

Cone	Cup	Series	d		R		D		r		T		Basic Load Rating	
			Cone Bore		Max Shaft Radius		Cup Outer Diameter		Max Housing Radius		Total Width		Dynamic Cr	Static Cor
			mm	inch	mm	inch	mm	inch	mm	inch	mm	inch	KN	KN
641	632	635	66.675	2.6250	3.5	0.14	136.525	5.3750	3.3	0.13	41.275	1.6250	192	258
641	633	635	66.675	2.6250	3.5	0.14	130.175	5.1250	3.3	0.13	41.275	1.6250	192	258
3984	3920	3900	66.675	2.6250	3.5	0.14	112.712	4.4375	3.3	0.13	30.162	1.1875	115	166
3994	3920	3900	66.675	2.6250	5.5	0.22	112.712	4.4375	3.3	0.13	30.162	1.1875	115	166
3984	3925	3900	66.675	2.6250	3.5	0.14	112.712	4.4375	0.8	0.03	30.162	1.1875	115	166
3994	3925	3900	66.675	2.6250	5.5	0.22	112.712	4.4375	0.8	0.03	30.162	1.1875	115	166
3984	3926	3900	66.675	2.6250	3.5	0.14	112.712	4.4375	3.3	0.13	33.338	1.3125	115	166
3994	3926	3900	66.675	2.6250	5.5	0.22	112.712	4.4375	3.3	0.13	33.338	1.3125	115	166
6386	6320	6300	66.675	2.6250	4.3	0.17	135.755	5.3447	3.3	0.13	53.975	2.1250	263	351
6389	6320	6300	66.675	2.6250	6.4	0.25	135.755	5.3447	3.3	0.13	53.975	2.1250	263	351
33262	33462	33000	66.675	2.6250	3.5	0.14	117.475	4.6250	3.3	0.13	30.162	1.1875	115	172
33262	33472	33000	66.675	2.6250	3.5	0.14	120.000	4.7244	0.8	0.03	29.794	1.1730	115	172
39590	39520	39500	66.675	2.6250	3.5	0.14	112.712	4.4375	3.3	0.13	30.162	1.1875	138	193
HM212049	HM212010	HM212000	66.675	2.6250	3.5	0.14	122.238	4.8125	1.5	0.06	38.100	1.5000	186	243
HM212049X	HM212010	HM212000	66.675	2.6250	7.0	0.28	122.238	4.8125	1.5	0.06	38.100	1.5000	186	243
HM212049	HM212011	HM212000	66.675	2.6250	3.5	0.14	122.238	4.8125	3.3	0.13	38.100	1.5000	186	243
HM212049X	HM212011	HM212000	66.675	2.6250	7.0	0.28	122.238	4.8125	3.3	0.13	38.100	1.5000	186	243
HM813844	HM813810	HM813800	66.675	2.6250	3.5	0.14	127.000	5.0000	3.3	0.13	36.512	1.4375	161	225
399A	393	395	68.262	2.6875	2.3	0.09	110.000	4.3307	0.8	0.03	27.000	1.0630	82.5	108
399AS	393	395	68.262	2.6875	5.0	0.20	110.000	4.3307	0.8	0.03	27.000	1.0630	82.5	108
399A	393AS	395	68.262	2.6875	2.3	0.09	111.125	4.3750	1.3	0.05	22.000	0.8661	82.5	108
399AS	393AS	395	68.262	2.6875	5.0	0.20	111.125	4.3750	1.3	0.05	22.000	0.8661	82.5	108
399A	394A	395	68.262	2.6875	2.3	0.09	110.000	4.3307	1.3	0.05	22.000	0.8661	82.5	108
399AS	394A	395	68.262	2.6875	5.0	0.20	110.000	4.3307	1.3	0.05	22.000	0.8661	82.5	108
399A	394AS	395	68.262	2.6875	2.3	0.09	110.000	4.3307	3.3	0.13	22.000	0.8661	82.5	108
399AS	394AS	395	68.262	2.6875	5.0	0.20	110.000	4.3307	3.3	0.13	22.000	0.8661	82.5	108
399A	3920	395	68.262	2.6875	2.3	0.09	112.712	4.4375	3.3	0.13	26.967	1.0617	82.5	108
399AS	3920	395	68.262	2.6875	5.0	0.20	112.712	4.4375	3.3	0.13	26.967	1.0617	82.5	108
480	472	475	68.262	2.6875	3.5	0.14	120.000	4.7244	2.0	0.08	29.794	1.1730	118	161
480	472A	475	68.262	2.6875	3.5	0.14	120.000	4.7244	3.3	0.13	29.002	1.1418	118	161
480	472X	475	68.262	2.6875	3.5	0.14	123.825	4.8750	3.3	0.13	30.162	1.1875	118	161
H715343	H715311	H715300	68.262	2.6875	3.5	0.14	136.525	5.3750	3.3	0.13	46.038	1.8125	226	356
H715343	H715313W	H715300	68.262	2.6875	3.5	0.14	136.525	5.3750	3.3	0.13	49.213	1.9375	226	356
482	472	475	69.850	2.7500	3.5	0.14	120.000	4.7244	2.0	0.08	29.794	1.1730	118	161

INCH AND ISO METRIC SERIES | BY CONE BORE

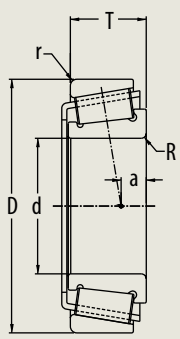

The tables include the most common industry series and sizes in the market. Additional industry series and sizes are available from PEER upon request.

Cone	Cup	Series	d		R		D		r		T		Basic Load Rating	
			Cone Bore		Max Shaft Radius		Cup Outer Diameter		Max Housing Radius		Total Width		Dynamic Cr	Static Cor
			mm	inch	mm	inch	mm	inch	mm	inch	mm	inch	KN	KN
482	472A	475	69.850	2.7500	3.5	0.14	120.000	4.7244	3.3	0.13	29.002	1.1418	118	161
482	472X	475	69.850	2.7500	3.5	0.14	123.825	4.8750	3.3	0.13	30.162	1.1875	118	161
643	632	635	69.850	2.7500	3.5	0.14	136.525	5.3750	3.3	0.13	41.275	1.6250	192	258
643	633	635	69.850	2.7500	3.5	0.14	130.175	5.1250	3.3	0.13	41.275	1.6250	192	258
745A	742	745	69.850	2.7500	3.5	0.14	150.089	5.9090	3.3	0.13	44.450	1.7500	260	361
835	832	835	69.850	2.7500	3.5	0.14	168.275	6.6250	3.3	0.13	53.975	2.1250	339	470
29675	29620	29600	69.850	2.7500	1.5	0.06	112.712	4.4375	3.3	0.13	25.400	1.0000	92.3	145
29675	29630	29600	69.850	2.7500	1.5	0.06	120.650	4.7500	3.3	0.13	25.400	1.0000	92.3	145
33275	33462	33000	69.850	2.7500	3.5	0.14	117.475	4.6250	3.3	0.13	30.162	1.1875	115	172
33275	33472	33000	69.850	2.7500	3.5	0.14	120.000	4.7244	0.8	0.03	29.794	1.1730	115	172
47487	47420A	47400	69.850	2.7500	3.5	0.14	120.000	4.7244	0.5	0.02	32.545	1.2813	147	214
484	472	475	70.000	2.7559	2.0	0.08	120.000	4.7244	2.0	0.08	29.794	1.1730	118	161
484	472A	475	70.000	2.7559	2.0	0.08	120.000	4.7244	3.3	0.13	29.002	1.1418	118	161
484	472X	475	70.000	2.7559	2.0	0.08	123.825	4.8750	3.3	0.13	30.162	1.1875	118	161
JLM813049	JLM813010	LM813000	70.000	2.7559	1.0	0.04	110.000	4.3307	2.5	0.10	26.000	1.0236	98.7	149
X30214	Y30214	30214	70.000	2.7559	2.0	0.08	125.000	4.9213	1.5	0.06	26.250	1.0335	125	152
X30314	Y30314	30314	70.000	2.7559	3.0	0.12	150.000	5.9055	2.5	0.10	38.000	1.4961	223	262
X31314	Y31314	31314	70.000	2.7559	3.0	0.12	150.000	5.9055	2.5	0.10	28.000	1.1024	190	223
X32014X	Y32014X	32014X	70.000	2.7559	1.5	0.06	110.000	4.3307	1.5	0.06	25.000	0.9843	99.4	150
X32214	Y32214	32214	70.000	2.7559	2.0	0.08	125.000	4.9213	1.5	0.06	33.250	1.3091	169	224
X32314	Y32314	32314	70.000	2.7559	3.0	0.12	150.000	5.9055	2.5	0.10	54.000	2.1260	313	407
X33014	Y33014	33014	70.000	2.7559	1.5	0.06	110.000	4.3307	1.5	0.06	31.000	1.2205	130	211
X33114	Y33114	33114	70.000	2.7559	2.0	0.08	120.000	4.7244	1.5	0.06	37.000	1.4567	166	255
X33214	Y33214	33214	70.000	2.7559	2.0	0.08	125.000	4.9213	1.5	0.06	41.000	1.6142	201	285
645	632	635	71.438	2.8125	6.4	0.25	136.525	5.3750	3.3	0.13	41.275	1.6250	192	258
645	633	635	71.438	2.8125	6.4	0.25	130.175	5.1250	3.3	0.13	41.275	1.6250	192	258
33281	33462	33000	71.438	2.8125	3.5	0.14	117.475	4.6250	3.3	0.13	30.162	1.1875	115	172
33281	33472	33000	71.438	2.8125	3.5	0.14	120.000	4.7244	0.8	0.03	29.794	1.1730	115	172
H715345	H715311	H715300	71.438	2.8125	3.5	0.14	136.525	5.3750	3.3	0.13	46.038	1.8125	226	356
H715345	H715313W	H715300	71.438	2.8125	3.5	0.14	136.525	5.3750	3.3	0.13	49.213	1.9375	226	356
567	563	565	73.025	2.8750	3.5	0.14	127.000	5.0000	3.3	0.13	36.512	1.4375	153	218
576	572	575	73.025	2.8750	3.5	0.14	139.992	5.5115	3.3	0.13	36.512	1.4375	170	251
576	572X	575	73.025	2.8750	3.5	0.14	139.700	5.5000	3.3	0.13	36.512	1.4375	170	251
744	742	745	73.025	2.8750	3.5	0.14	150.089	5.9090	3.3	0.13	44.450	1.7500	260	361

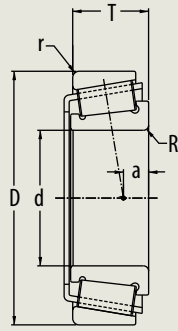

The tables include the most common industry series and sizes in the market. Additional industry series and sizes are available from PEER upon request.

Cone	Cup	Series	d		R		D		r		T		Basic Load Rating	
			Cone Bore		Max Shaft Radius		Cup Outer Diameter		Max Housing Radius		Total Width		Dynamic Cr	Static Cor
			mm	inch	mm	inch	mm	inch	mm	inch	mm	inch	KN	KN
29685	29620	29600	73.025	2.8750	3.5	0.14	112.712	4.4375	3.3	0.13	25.400	1.0000	92.3	145
29685	29630	29600	73.025	2.8750	3.5	0.14	120.650	4.7500	3.3	0.13	25.400	1.0000	92.3	145
33287	33462	33000	73.025	2.8750	3.5	0.14	117.475	4.6250	3.3	0.13	30.162	1.1875	115	172
33287	33472	33000	73.025	2.8750	3.5	0.14	120.000	4.7244	0.8	0.03	29.794	1.1730	115	172
29688	29620	29600	73.817	2.9062	1.5	0.06	112.712	4.4375	3.3	0.13	25.400	1.0000	92.3	145
29688	29630	29600	73.817	2.9062	1.5	0.06	120.650	4.7500	3.3	0.13	25.400	1.0000	92.3	145
577	572	575	74.612	2.9375	3.5	0.14	139.992	5.5115	3.3	0.13	36.512	1.4375	170	251
577	572X	575	74.612	2.9375	3.5	0.14	139.700	5.5000	3.3	0.13	36.512	1.4375	170	251
JLM714149	JLM714110	LM714100	75.000	2.9528	3.0	0.12	115.000	4.5276	2.5	0.10	25.000	0.9843	97.7	143
JM714249	JM714210	M714200	75.000	2.9528	3.0	0.12	120.000	4.7244	2.5	0.10	31.000	1.2205	141	206
X30215	Y30215	30215	75.000	2.9528	2.0	0.08	130.000	5.1181	1.5	0.06	27.250	1.0728	137	172
X30315	Y30315	30315	75.000	2.9528	3.0	0.12	160.000	6.2992	2.5	0.10	40.000	1.5748	258	309
X31315	Y31315	31315	75.000	2.9528	3.0	0.12	160.000	6.2992	2.5	0.10	40.000	1.5748	213	250
X32015X	Y32015X	32015X	75.000	2.9528	1.5	0.06	115.000	4.5276	1.5	0.06	25.000	0.9843	98.2	151
X32215	Y32215	32215	75.000	2.9528	2.0	0.08	130.000	5.1181	1.5	0.06	33.250	1.3091	170	228
X32315	Y32315	32315	75.000	2.9528	3.0	0.12	160.000	6.2992	2.5	0.10	58.000	2.2835	358	473
X33015	Y33015	33015	75.000	2.9528	1.5	0.06	115.000	4.5276	1.5	0.06	31.000	1.2205	129	211
X33115	Y33115	33115	75.000	2.9528	2.0	0.08	125.000	4.9213	1.5	0.06	37.000	1.4567	170	268
X33215	Y33215	33215	75.000	2.9528	2.0	0.08	130.000	5.1181	1.5	0.06	41.000	1.6142	209	286
495A	492A	495	76.200	3.0000	3.5	0.14	133.350	5.2500	3.3	0.13	30.162	1.1875	128	188
495AX	492A	495	76.200	3.0000	6.4	0.25	133.350	5.2500	3.3	0.13	30.162	1.1875	128	188
495A	493	495	76.200	3.0000	3.5	0.14	136.525	5.3750	3.3	0.13	30.162	1.1875	128	188
495AX	493	495	76.200	3.0000	6.4	0.25	136.525	5.3750	3.3	0.13	30.162	1.1875	128	188
575	572	575	76.200	3.0000	3.5	0.14	139.992	5.5115	3.3	0.13	36.512	1.4375	170	251
575-S	572	575	76.200	3.0000	6.8	0.27	139.992	5.5115	3.3	0.13	36.512	1.4375	170	251
575	572X	575	76.200	3.0000	3.5	0.14	139.700	5.5000	3.3	0.13	36.512	1.4375	170	251
575-S	572X	575	76.200	3.0000	6.8	0.27	139.700	5.5000	3.3	0.13	36.512	1.4375	170	251
659	652	655	76.200	3.0000	3.5	0.14	152.400	6.0000	3.3	0.13	41.275	1.6250	203	288
659	653	655	76.200	3.0000	3.5	0.14	146.050	5.7500	3.3	0.13	41.275	1.6250	203	288
5760	5735	5700	76.200	3.0000	3.5	0.14	135.733	5.3438	3.3	0.13	44.450	1.7500	227	343
6461A	6420	6400	76.200	3.0000	9.7	0.38	149.225	5.8750	3.3	0.13	53.975	2.1250	284	403
6576	6535	6500	76.200	3.0000	3.5	0.14	161.925	6.3750	3.3	0.13	53.974	2.1250	329	505
9285	9220	9200	76.200	3.0000	3.5	0.14	161.925	6.3750	3.3	0.13	49.212	1.9375	245	287
42687	42620	42600	76.200	3.0000	3.5	0.14	127.000	5.0000	3.3	0.13	30.162	1.1875	138	199

INCH AND ISO METRIC SERIES | BY CONE BORE

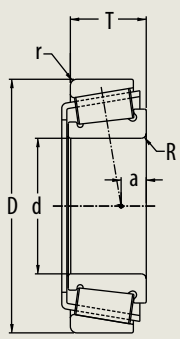

The tables include the most common industry series and sizes in the market. Additional industry series and sizes are available from PEER upon request.

Cone	Cup	Series	d		R		D		r		T		Basic Load Rating	
			Cone Bore		Max Shaft Radius		Cup Outer Diameter		Max Housing Radius		Total Width		Dynamic Cr	Static Cor
			mm	inch	mm	inch	mm	inch	mm	inch	mm	inch	KN	KN
47678	47620	47600	76.200	3.0000	6.4	0.25	133.350	5.2500	3.3	0.13	33.338	1.3125	149	227
47679	47620	47600	76.200	3.0000	3.5	0.14	133.350	5.2500	3.3	0.13	33.338	1.3125	149	227
5795	5735	5700	77.788	3.0625	3.5	0.14	135.733	5.3438	3.3	0.13	44.450	1.7500	227	343
34306	34478	34000	77.788	3.0625	3.5	0.14	121.442	4.7812	2.0	0.08	24.607	0.9688	86.6	120
34306	34492A	34000	77.788	3.0625	3.5	0.14	125.095	4.9250	2.0	0.08	23.731	0.9343	86.6	120
LM814849	LM814810	LM814800	77.788	3.0625	3.5	0.14	117.475	4.6250	3.3	0.13	25.400	1.0000	97.1	156
756A	752	755	79.375	3.1250	8.0	0.31	161.925	6.3750	3.3	0.13	47.625	1.8750	270	384
748	742	745	80.000	3.1496	3.0	0.12	150.089	5.9090	3.3	0.13	44.450	1.7500	260	361
X30216	Y30216	30216	80.000	3.1496	2.5	0.10	140.000	5.5118	2.0	0.08	28.250	1.1122	158	198
X30316	Y30316	30316	80.000	3.1496	3.0	0.12	170.000	6.6929	2.5	0.10	42.500	1.6732	287	345
X31316	Y31316	31316	80.000	3.1496	3.0	0.12	170.000	6.6929	2.5	0.10	42.500	1.6732	236	280
X32016X	Y32016X	32016X	80.000	3.1496	1.5	0.06	125.000	4.9213	1.5	0.06	29.000	1.1417	135	209
X32216	Y32216	32216	80.000	3.1496	2.5	0.10	140.000	5.5118	2.0	0.08	35.250	1.3878	199	264
X32316	Y32316	32316	80.000	3.1496	3.0	0.12	170.000	6.6929	2.5	0.10	61.500	2.4213	402	535
X33016	Y33016	33016	80.000	3.1496	1.5	0.06	125.000	4.9213	1.5	0.06	36.000	1.4173	177	293
X33116	Y33116	33116	80.000	3.1496	2.0	0.08	130.000	5.1181	1.5	0.06	37.000	1.4567	173	279
X33216	Y33216	33216	80.000	3.1496	2.5	0.10	140.000	5.5118	2.0	0.08	46.000	1.8110	238	347
496	492A	495	80.962	3.1875	3.5	0.14	133.350	5.2500	3.3	0.13	30.162	1.1875	128	188
496	493	495	80.962	3.1875	3.5	0.14	136.525	5.3750	3.3	0.13	30.162	1.1875	128	188
581	572	575	80.962	3.1875	3.5	0.14	139.992	5.5115	3.3	0.13	36.512	1.4375	170	251
581	572X	575	80.962	3.1875	3.5	0.14	139.700	5.5000	3.3	0.13	36.512	1.4375	170	251
662	652	655	80.962	3.1875	3.5	0.14	152.400	6.0000	3.3	0.13	38.100	1.5000	203	288
662	653	655	80.962	3.1875	3.5	0.14	146.050	5.7500	3.3	0.13	38.100	1.5000	203	288
740	742	745	80.962	3.1875	5.0	0.20	150.089	5.9090	3.3	0.13	44.450	1.7500	260	361
47681	47620	47600	80.962	3.1875	3.5	0.14	133.350	5.2500	3.3	0.13	33.338	1.3125	149	227
495	492A	495	82.550	3.2500	3.5	0.14	133.350	5.2500	3.3	0.13	30.162	1.1875	128	188
495	493	495	82.550	3.2500	3.5	0.14	136.525	5.3750	3.3	0.13	30.162	1.1875	128	188
580	572	575	82.550	3.2500	3.5	0.14	139.992	5.5115	3.3	0.13	36.512	1.4375	170	251
582	572	575	82.550	3.2500	6.8	0.27	139.992	5.5115	3.3	0.13	36.512	1.4375	170	251
580	572X	575	82.550	3.2500	3.5	0.14	139.700	5.5000	3.3	0.13	36.512	1.4375	170	251
582	572X	575	82.550	3.2500	6.8	0.27	139.700	5.5000	3.3	0.13	36.512	1.4375	170	251
595	592	595	82.550	3.2500	3.5	0.14	152.400	6.0000	3.3	0.13	39.688	1.5625	179	277
595	592A	595	82.550	3.2500	3.5	0.14	152.400	6.0000	3.3	0.13	39.688	1.5625	179	277
595	592XS	595	82.550	3.2500	3.5	0.14	147.638	5.8125	3.3	0.13	35.718	1.4062	179	277

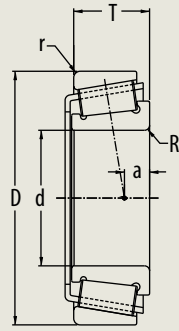

The tables include the most common industry series and sizes in the market. Additional industry series and sizes are available from PEER upon request.

Cone	Cup	Series	d		R		D		r		T		Basic Load Rating	
			Cone Bore		Max Shaft Radius		Cup Outer Diameter		Max Housing Radius		Total Width		Dynamic Cr	Static Cor
			mm	inch	mm	inch	mm	inch	mm	inch	mm	inch	mm	inch
595	593X	595	82.550	3.2500	3.5	0.14	150.000	5.9055	3.0	0.12	35.992	1.4170	179	277
663	652	655	82.550	3.2500	3.5	0.14	152.400	6.0000	3.3	0.13	41.275	1.6250	203	288
663	653	655	82.550	3.2500	3.5	0.14	146.050	5.7500	3.3	0.13	41.275	1.6250	203	288
749A	742	745	82.550	3.2500	3.5	0.14	150.089	5.9090	3.3	0.13	44.450	1.7500	260	361
750A	742	745	82.550	3.2500	6.5	0.26	150.089	5.9090	3.3	0.13	44.450	1.7500	260	361
27687	27620	27600	82.550	3.2500	3.5	0.14	125.412	4.9375	1.5	0.06	25.400	1.0000	96.7	152
47685	47620	47600	82.550	3.2500	0.8	0.03	133.350	5.2500	3.3	0.13	33.338	1.3125	149	227
47686	47620	47600	82.550	3.2500	3.5	0.14	133.350	5.2500	3.3	0.13	33.338	1.3125	149	227
47687	47620	47600	82.550	3.2500	6.8	0.27	133.350	5.2500	3.3	0.13	33.338	1.3125	149	227
HM516448	HM516410	HM516400	82.550	3.2500	6.8	0.27	133.350	5.2500	3.3	0.13	39.687	1.5625	181	315
HM516449A	HM516410	HM516400	82.550	3.2500	6.2	0.24	133.350	5.2500	3.3	0.13	39.687	1.5625	181	315
HM516449C	HM516410	HM516400	82.550	3.2500	3.5	0.14	133.350	5.2500	3.3	0.13	39.687	1.5625	181	315
HM516448	HM516414-B	HM516400	82.550	3.2500	6.8	0.27	136.525	5.3750	1.5	0.06	39.687	1.5625	181	315
HM516449A	HM516414-B	HM516400	82.550	3.2500	6.2	0.24	136.525	5.3750	1.5	0.06	39.687	1.5625	181	315
HM516449C	HM516414-B	HM516400	82.550	3.2500	3.5	0.14	136.525	5.3750	1.5	0.06	39.687	1.5625	181	315
27689	27620	27600	83.345	3.2813	0.8	0.03	125.412	4.9375	1.5	0.06	25.400	1.0000	96.7	152
498	492A	495	84.138	3.3125	3.5	0.14	133.350	5.2500	3.3	0.13	30.162	1.1875	128	188
498	493	495	84.138	3.3125	3.5	0.14	136.525	5.3750	3.3	0.13	30.162	1.1875	128	188
JHM516849	JHM516810	HM516800	85.000	3.3465	3.0	0.12	140.000	5.5118	2.5	0.10	39.000	1.5354	197	295
JM716649	JM716610	M716600	85.000	3.3465	3.0	0.12	130.000	5.1181	2.5	0.10	30.000	1.1811	135	215
X30217	Y30217	30217	85.000	3.3465	2.5	0.10	150.000	5.9055	2.0	0.08	30.500	1.2008	176	221
X30317	Y30317	30317	85.000	3.3465	4.0	0.16	180.000	7.0866	3.0	0.12	44.500	1.7520	314	380
X31317	Y31317	31317	85.000	3.3465	4.0	0.16	180.000	7.0866	3.0	0.12	44.500	1.7520	261	312
X32017X	Y32017X	32017X	85.000	3.3465	1.5	0.06	130.000	5.1181	1.5	0.06	29.000	1.1417	133	207
X32217	Y32217	32217	85.000	3.3465	2.5	0.10	150.000	5.9055	2.0	0.08	38.500	1.5157	232	314
X32317	Y32317	32317	85.000	3.3465	4.0	0.16	180.000	7.0866	3.0	0.12	63.500	2.5000	437	584
X33017	Y33017	33017	85.000	3.3465	1.5	0.06	130.000	5.1181	1.5	0.06	36.000	1.4173	175	294
X33117	Y33117	33117	85.000	3.3465	2.5	0.10	140.000	5.5118	2.0	0.08	41.000	1.6142	209	340
X33217	Y33217	33217	85.000	3.3465	2.5	0.10	150.000	5.9055	2.0	0.08	49.000	1.9291	273	400
749	742	745	85.026	3.3475	3.5	0.14	150.089	5.9090	3.3	0.13	44.450	1.7500	260	361
749-S	742	745	85.026	3.3475	5.0	0.20	150.089	5.9090	3.3	0.13	44.450	1.7500	260	361
497	492A	495	85.725	3.3750	3.5	0.14	133.350	5.2500	3.3	0.13	30.162	1.1875	128	188
497	493	495	85.725	3.3750	3.5	0.14	136.525	5.3750	3.3	0.13	30.162	1.1875	128	188
596	592	595	85.725	3.3750	3.5	0.14	152.400	6.0000	3.3	0.13	39.688	1.5625	179	277

INCH AND ISO METRIC SERIES | BY CONE BORE

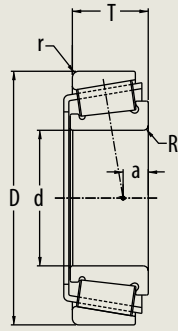

The tables include the most common industry series and sizes in the market. Additional industry series and sizes are available from PEER upon request.

Cone	Cup	Series	d		R		D		r		T		Basic Load Rating	
			Cone Bore		Max Shaft Radius		Cup Outer Diameter		Max Housing Radius		Total Width		Dynamic Cr	Static Cor
			mm	inch	mm	inch	mm	inch	mm	inch	mm	inch	KN	KN
596	592A	595	85.725	3.3750	3.5	0.14	152.400	6.0000	3.3	0.13	39.688	1.5625	179	277
596	592XS	595	85.725	3.3750	3.5	0.14	147.638	5.8125	3.3	0.13	35.718	1.4062	179	277
596	593X	595	85.725	3.3750	3.5	0.14	150.000	5.9055	3.0	0.12	35.992	1.4170	179	277
665	652	655	85.725	3.3750	3.5	0.14	152.400	6.0000	3.3	0.13	41.275	1.6250	203	288
665A	652	655	85.725	3.3750	6.4	0.25	152.400	6.0000	3.3	0.13	41.275	1.6250	203	288
665	653	655	85.725	3.3750	3.5	0.14	146.050	5.7500	3.3	0.13	41.275	1.6250	203	288
665A	653	655	85.725	3.3750	6.4	0.25	146.050	5.7500	3.3	0.13	41.275	1.6250	203	288
758	752	755	85.725	3.3750	3.5	0.14	161.925	6.3750	3.3	0.13	47.625	1.8750	270	384
HM617049	HM617010	HM617000	85.725	3.3750	4.8	0.19	142.138	5.5960	3.3	0.13	42.863	1.6875	214	338
869	854	855	87.312	3.4375	8.0	0.31	190.500	7.5000	3.3	0.13	57.150	2.2500	381	557
593	592	595	88.900	3.5000	3.5	0.14	152.400	6.0000	3.3	0.13	39.688	1.5625	179	277
593A	592	595	88.900	3.5000	6.4	0.25	152.400	6.0000	3.3	0.13	39.688	1.5625	179	277
593	592A	595	88.900	3.5000	3.5	0.14	152.400	6.0000	3.3	0.13	39.688	1.5625	179	277
593A	592A	595	88.900	3.5000	6.4	0.25	152.400	6.0000	3.3	0.13	39.688	1.5625	179	277
593	592XS	595	88.900	3.5000	3.5	0.14	147.638	5.8125	3.3	0.13	35.718	1.4062	179	277
593A	592XS	595	88.900	3.5000	6.4	0.25	147.638	5.8125	3.3	0.13	35.718	1.4062	179	277
593	593X	595	88.900	3.5000	3.5	0.14	150.000	5.9055	3.0	0.12	35.992	1.4170	179	277
593A	593X	595	88.900	3.5000	6.4	0.25	150.000	5.9055	3.0	0.12	35.992	1.4170	179	277
759	752	755	88.900	3.5000	3.5	0.14	161.925	6.3750	3.3	0.13	47.625	1.8750	270	384
855	854	855	88.900	3.5000	8.0	0.31	190.500	7.5000	3.3	0.13	57.150	2.2500	381	557
6580	6535	6500	88.900	3.5000	3.5	0.14	161.925	6.3750	3.3	0.13	53.974	2.1250	329	505
L217849	L217810	L217800	88.900	3.5000	1.5	0.06	123.825	4.8750	1.5	0.06	20.637	0.8125	78.2	137
HM518445	HM518410	HM518400	88.900	3.5000	6.4	0.25	152.400	6.0000	3.3	0.13	39.688	1.5625	248	354
HM218248	HM218210	HM218200	89.974	3.5423	7.0	0.28	146.975	5.7864	3.5	0.14	40.000	1.5748	224	335
JM718149	JM718110	M718100	90.000	3.5433	3.0	0.12	140.000	5.5118	2.5	0.10	35.000	1.3780	188	277
X30218	Y30218	30218	90.000	3.5433	2.5	0.10	160.000	6.2992	2.0	0.08	32.500	1.2795	203	259
X30318	Y30318	30318	90.000	3.5433	4.0	0.16	190.000	7.4803	3.0	0.12	46.500	1.8307	353	432
X31318	Y31318	31318	90.000	3.5433	4.0	0.16	190.000	7.4803	3.0	0.12	46.500	1.8307	290	349
X32018X	Y32018X	32018X	90.000	3.5433	2.0	0.08	140.000	5.5118	1.5	0.06	32.000	1.2598	164	256
X32218	Y32218	32218	90.000	3.5433	2.5	0.10	160.000	6.2992	2.0	0.08	42.500	1.6732	276	385
X33018	Y33018	33018	90.000	3.5433	2.0	0.08	140.000	5.5118	1.5	0.06	39.000	1.5354	216	355
X33118	Y33118	33118	90.000	3.5433	2.5	0.10	150.000	5.9055	2.0	0.08	45.000	1.7717	244	398
760	752	755	90.488	3.5625	3.5	0.14	161.925	6.3750	3.3	0.13	47.625	1.8750	270	384
598	592	595	92.075	3.6250	3.5	0.14	152.400	6.0000	3.3	0.13	39.688	1.5625	179	277

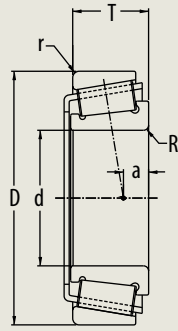

The tables include the most common industry series and sizes in the market. Additional industry series and sizes are available from PEER upon request.

Cone	Cup	Series	d		R		D		r		T		Basic Load Rating	
			Cone Bore		Max Shaft Radius		Cup Outer Diameter		Max Housing Radius		Total Width		Dynamic Cr	Static Cor
			mm	inch	mm	inch	mm	inch	mm	inch	mm	inch	KN	KN
598A	592	595	92.075	3.6250	6.4	0.25	152.400	6.0000	3.3	0.13	39.688	1.5625	179	277
598	592A	595	92.075	3.6250	3.5	0.14	152.400	6.0000	3.3	0.13	39.688	1.5625	179	277
598A	592A	595	92.075	3.6250	6.4	0.25	152.400	6.0000	3.3	0.13	39.688	1.5625	179	277
598	592XS	595	92.075	3.6250	3.5	0.14	147.638	5.8125	3.3	0.13	35.718	1.4062	179	277
598A	592XS	595	92.075	3.6250	6.4	0.25	147.638	5.8125	3.3	0.13	35.718	1.4062	179	277
598	593X	595	92.075	3.6250	3.5	0.14	150.000	5.9055	3.0	0.12	35.992	1.4170	179	277
598A	593X	595	92.075	3.6250	6.4	0.25	150.000	5.9055	3.0	0.12	35.992	1.4170	179	277
681	672	675	92.075	3.6250	3.5	0.14	168.275	6.6250	3.3	0.13	41.275	1.6250	219	335
681A	672	675	92.075	3.6250	6.4	0.25	168.275	6.6250	3.3	0.13	41.275	1.6250	219	335
857	854	855	92.075	3.6250	8.0	0.31	190.500	7.5000	3.3	0.13	57.150	2.2500	381	557
47890	47820	47800	92.075	3.6250	3.5	0.14	146.050	5.7500	3.3	0.13	33.338	1.3125	172	281
864	854	855	92.250	3.6319	8.0	0.31	190.500	7.5000	3.3	0.13	57.150	2.2500	381	557
42368	42584	42000	93.662	3.6875	3.0	0.12	148.430	5.8437	3.0	0.12	28.575	1.1250	137	214
JM719149	JM719113	M719100	95.000	3.7402	3.0	0.12	150.000	5.9055	2.5	0.10	35.000	1.3780	179	277
JL819349	JL819310	L819300	95.000	3.7402	5.0	0.20	135.000	5.3150	2.5	0.10	20.000	0.7874	76.3	132
X30219	Y30219	30219	95.000	3.7402	3.0	0.12	170.000	6.6929	2.5	0.10	34.500	1.3583	230	298
X30319	Y30319	30319	95.000	3.7402	4.0	0.16	200.000	7.8740	3.0	0.12	49.500	1.9488	381	468
X32019X	Y32019X	32019X	95.000	3.7402	2.0	0.08	145.000	5.7087	1.5	0.06	32.000	1.2598	167	266
X32219	Y32219	32219	95.000	3.7402	3.0	0.12	170.000	6.6929	2.5	0.10	45.500	1.7913	310	437
X33019	Y33019	33019	95.000	3.7402	2.0	0.08	145.000	5.7087	1.5	0.06	39.000	1.5354	224	374
594	592	595	95.250	3.7500	3.5	0.14	152.400	6.0000	3.3	0.13	39.688	1.5625	179	277
594A	592	595	95.250	3.7500	5.0	0.20	152.400	6.0000	3.3	0.13	39.688	1.5625	179	277
594	592A	595	95.250	3.7500	3.5	0.14	152.400	6.0000	3.3	0.13	39.688	1.5625	179	277
594A	592A	595	95.250	3.7500	5.0	0.20	152.400	6.0000	3.3	0.13	39.688	1.5625	179	277
594	592XS	595	95.250	3.7500	3.5	0.14	147.638	5.8125	3.3	0.13	35.718	1.4062	179	277
594A	592XS	595	95.250	3.7500	5.0	0.20	147.638	5.8125	3.3	0.13	35.718	1.4062	179	277
594	593X	595	95.250	3.7500	3.5	0.14	150.000	5.9055	3.0	0.12	35.992	1.4170	179	277
594A	593X	595	95.250	3.7500	5.0	0.20	150.000	5.9055	3.0	0.12	35.992	1.4170	179	277
683	672	675	95.250	3.7500	3.5	0.14	168.275	6.6250	3.3	0.13	41.275	1.6250	219	335
683XA	672	675	95.250	3.7500	5.0	0.20	168.275	6.6250	3.3	0.13	41.275	1.6250	219	335
47896	47820	47800	95.250	3.7500	3.5	0.14	146.050	5.7500	3.3	0.13	33.338	1.3125	172	281
42381	42584	42000	96.838	3.8125	3.5	0.14	148.430	5.8437	3.0	0.12	28.575	1.1250	137	214
685	672	675	98.425	3.8750	3.5	0.14	168.275	6.6250	3.3	0.13	41.275	1.6250	219	335
866	854	855	98.425	3.8750	3.5	0.14	190.500	7.5000	3.3	0.13	57.150	2.2500	381	557

INCH AND ISO METRIC SERIES | BY CONE BORE

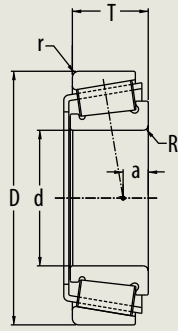

The tables include the most common industry series and sizes in the market. Additional industry series and sizes are available from PEER upon request.

Cone	Cup	Series	d		R		D		r		T		Basic Load Rating	
			Cone Bore		Max Shaft Radius		Cup Outer Diameter		Max Housing Radius		Total Width		Dynamic Cr	Static Cor
			mm	inch	mm	inch	mm	inch	mm	inch	mm	inch	KN	KN
52387	52618	52000	98.425	3.8750	3.5	0.14	157.162	6.1875	3.3	0.13	36.512	1.4375	186	299
52387	52638	52000	98.425	3.8750	3.5	0.14	161.925	6.3750	3.3	0.13	39.687	1.5625	186	299
HM220149	HM220110	HM220100	99.974	3.9360	8.0	0.31	156.975	6.1801	3.5	0.14	42.000	1.6535	242	385
JHM720249	JHM720210	HM720200	100.000	3.9370	3.0	0.12	160.000	6.2992	2.5	0.10	41.000	1.6142	232	364
X30220	Y30220	30220	100.000	3.9370	3.0	0.12	180.000	7.0866	2.5	0.10	37.000	1.4567	259	339
X30320	Y30320	30320	100.000	3.9370	4.0	0.16	215.000	8.4646	3.0	0.12	51.500	2.0276	426	526
X32020X	Y32020X	32020X	100.000	3.9370	2.0	0.08	150.000	5.9055	1.5	0.06	32.000	1.2598	165	266
X32220	Y32220	32220	100.000	3.9370	3.0	0.12	180.000	7.0866	2.5	0.10	49.000	1.9291	351	501
X33020	Y33020	33020	100.000	3.9370	2.0	0.08	150.000	5.9055	1.5	0.06	39.000	1.5354	224	390
687	672	675	101.600	4.0000	3.5	0.14	168.275	6.6250	3.3	0.13	41.275	1.6250	219	335
780	772	775	101.600	4.0000	3.5	0.14	180.975	7.1250	3.3	0.13	47.625	1.8750	285	430
861	854	855	101.600	4.0000	8.0	0.31	190.500	7.5000	3.3	0.13	57.150	2.2500	381	557
52400	52618	52000	101.600	4.0000	3.5	0.14	157.162	6.1875	3.3	0.13	36.512	1.4375	186	299
52401	52618	52000	101.600	4.0000	8.0	0.31	157.162	6.1875	3.3	0.13	36.512	1.4375	186	299
52400	52638	52000	101.600	4.0000	3.5	0.14	161.925	6.3750	3.3	0.13	39.687	1.5625	186	299
52401	52638	52000	101.600	4.0000	8.0	0.31	161.925	6.3750	3.3	0.13	39.687	1.5625	186	299
HH221449	HH221410	HH221400	101.600	4.0000	8.0	0.31	190.500	7.5000	3.3	0.13	57.150	2.2500	447	616
689	672	675	103.188	4.0625	3.5	0.14	168.275	6.6250	3.3	0.13	41.275	1.6250	219	335
X30221	Y30221	30221	105.000	4.1339	3.0	0.12	190.000	7.4803	2.5	0.10	39.000	1.5354	291	386
X30321	Y30321	30321	105.000	4.1339	4.0	0.16	225.000	8.8583	3.0	0.12	53.500	2.1063	454	562
X32021X	Y32021X	32021X	105.000	4.1339	2.5	0.10	160.000	6.2992	2.0	0.08	35.000	1.3780	196	317
X32221	Y32221	32221	105.000	4.1339	3.0	0.12	190.000	7.4803	2.5	0.10	53.000	2.0866	392	567
X33021	Y33021	33021	105.000	4.1339	2.5	0.10	160.000	6.2992	2.0	0.08	43.000	1.6929	249	419
56418	56650	56000	106.362	4.1875	3.5	0.14	165.100	6.5000	3.3	0.13	36.512	1.4375	194	322
936	932	935	107.950	4.2500	8.0	0.31	212.725	8.3750	3.3	0.13	66.675	2.6250	446	677
56425	56650	56000	107.950	4.2500	3.5	0.14	165.100	6.5000	3.3	0.13	36.512	1.4375	194	322
JHM522649A	JHM522610	HM522600	110.000	4.3307	3.0	0.12	180.000	7.0866	2.5	0.10	47.000	1.8504	305	481
JM822049	JM822010	M822000	110.000	4.3307	3.0	0.12	165.000	6.4961	2.5	0.10	35.000	1.3780	201	336
X30222	Y30222	30222	110.000	4.3307	3.0	0.12	200.000	7.8740	2.5	0.10	41.000	1.6142	322	430
X30322	Y30322	30322	110.000	4.3307	4.0	0.16	240.000	9.4488	3.0	0.12	54.500	2.1457	495	612
X32022X	Y32022X	32022X	110.000	4.3307	2.5	0.10	170.000	6.6929	2.0	0.08	38.000	1.4961	234	380
X32222	Y32222	32222	110.000	4.3307	3.0	0.12	200.000	7.8740	2.5	0.10	56.000	2.2047	447	657
X33022	Y33022	33022	110.000	4.3307	2.5	0.10	170.000	6.6929	2.0	0.08	47.000	1.8504	280	483
938	932	935	114.300	4.5000	7.0	0.28	212.725	8.3750	3.3	0.13	66.675	2.6250	446	677

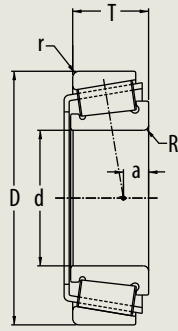

The tables include the most common industry series and sizes in the market. Additional industry series and sizes are available from PEER upon request.

Cone	Cup	Series	d		R		D		r		T		Basic Load Rating	
			Cone Bore		Max Shaft Radius		Cup Outer Diameter		Max Housing Radius		Total Width		Dynamic Cr	Static Cor
			mm	inch	mm	inch	mm	inch	mm	inch	mm	inch	KN	KN
64450	64700	64000	114.300	4.5000	3.5	0.14	177.800	7.0000	3.3	0.13	41.275	1.6250	228	366
X30224	Y30224	30224	120.000	4.7244	3.0	0.12	215.000	8.4646	2.5	0.10	43.500	1.7126	348	473
X32024X	Y32024X	32024X	120.000	4.7244	2.5	0.10	180.000	7.0866	2.0	0.08	38.000	1.4961	231	381
X32224	Y32224	32224	120.000	4.7244	3.0	0.12	215.000	8.4646	2.5	0.10	61.500	2.4213	495	748
795	792	795	120.650	4.7500	3.3	0.13	206.375	8.1250	3.3	0.13	47.625	1.8750	313	517
48286	48220	48200	123.825	4.8750	3.5	0.14	182.562	7.1875	3.3	0.13	39.688	1.5626	221	413
67388	67322	67300	127.000	5.0000	3.5	0.14	196.850	7.7500	3.3	0.13	46.038	1.8125	305	545
67388	67324	67300	127.000	5.0000	3.5	0.14	203.200	8.0000	3.3	0.13	46.038	1.8125	305	545
797	792	795	130.000	5.1181	3.5	0.14	206.375	8.1250	3.3	0.13	47.625	1.8750	313	517
X30226	Y30226	30226	130.000	5.1181	4.0	0.16	230.000	9.0551	3.0	0.12	43.750	1.7224	377	510
X32026X	Y32026X	32026X	130.000	5.1181	2.5	0.10	200.000	7.8740	2.0	0.08	45.000	1.7717	321	540
67390	67322	67300	133.350	5.2500	3.5	0.14	196.850	7.7500	3.3	0.13	46.038	1.8125	305	545
67390	67324	67300	133.350	5.2500	3.5	0.14	203.200	8.0000	3.3	0.13	46.038	1.8125	305	545
X32028X	Y32028X	32028X	140.000	5.5118	2.5	0.10	210.000	8.2677	2.0	0.08	45.000	1.7717	317	541
48684	48620	48600	142.875	5.6250	7.9	0.31	200.025	7.8750	3.3	0.13	77.788	3.0625	248	498
X32030X	Y32030X	32030X	150.000	5.9055	3.0	0.12	225.000	8.8583	2.5	0.10	48.000	1.8898	360	620
X32032X	Y32032X	32032X	160.000	6.2992	3.0	0.12	240.000	9.4488	2.5	0.10	51.000	2.0079	412	718
46790	46720	46700	165.100	6.5000	3.5	0.14	225.425	8.8750	3.3	0.13	41.275	1.6250	265	570
JM738249	JM738210	M738200	190.000	7.4803	3.0	0.12	260.000	10.2362	2.5	0.10	46.000	1.8110	359	699



PEER® Bearing offers

- *A wide range of agricultural, radial, mounted unit ball bearings, and tapered roller bearings*
- *Valued bearing solutions for agricultural, electrical, fluid, HVAC, industrial transmission, material handling and off-highway applications*
- *ISO/TS 16949 certified production facilities*
- *Dedicated Research and Development center*
- *Global application and customer support*

° PEER Bearing is a registered trademark of the SKF Group.
© PEER Bearing 2021

The contents of this publication are the copyright of the publisher and may not be reproduced (even extracts) unless prior written permission is granted. Every care has been taken to ensure the accuracy of the information contained in this publication but no liability can be accepted for any loss or damage whether direct, indirect or consequential arising out of the use of the information contained herein.

TRB CAT ENG LETTER VER1b_032021
Certain image(s) used under license from Shutterstock.com